

CATALOGUE 2021

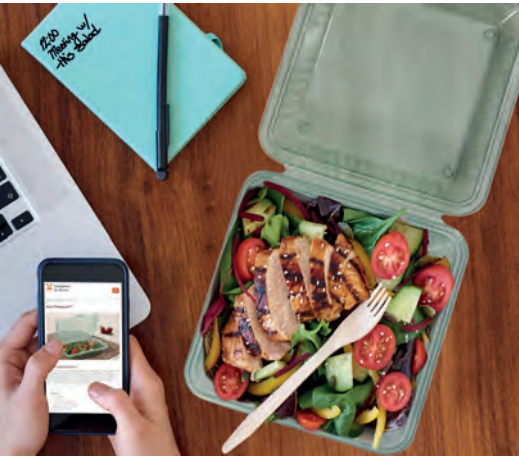

Nos marques

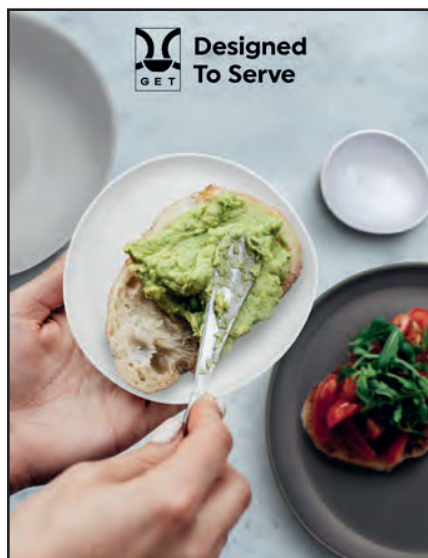

Avda. Sierra de Grazalema, 25 · 28691 Villanueva de la Cañada - Madrid - ESPAGNE

· E 918 125 580 · F 918 125 582 · info@dbmark.com

Service client 01 86 26 67 28

www.dbmark.com

Retrouvez-nous sur :



Cher professionnel

Merci de votre intérêt pour nos produits. Dans les pages suivantes, vous trouverez la plus large gamme de matériel hôtelier en polypropylène et mélamine du marché, fruit du travail réalisé par **DBMARK** avec de **grandes marques** que nous sommes fiers de représenter depuis plus de 25 ans. Nos marques ont toujours été très demandées par les professionnels de l'hôtellerie les plus exigeants au monde et sont appréciées pour leur excellente capacité de fabrication et pour leur assurance de qualité. Cette **garantie** est commercialement assurée par **DBMARK** pour atteindre notre objectif de contribuer à **l'amélioration du monde de l'hôtellerie**.

Notre engagement dans le secteur est de fournir des produits bien conçus et fabriqués accomplissant des fonctions spécifiques pour contribuer à travailler plus efficacement dans une cuisine, rendre plus attrayantes les offres de produits, réduire les coûts et minimiser les risques sanitaires. De plus, nous avons le soutien du plus grand réseau de distributeurs spécialisés en Europe, afin que nous puissions atteindre notre objectif, en proposant des produits de grandes marques à des prix attractifs et compétitifs.

Au-delà de notre réseau de distributeurs, les **personnes** qui composent **DBMARK** sont à votre disposition pour répondre à vos questions, doutes ou commentaires. Écrivez-nous à cleconnetable@dbmark.com, visitez www.dbmark.com ou appelez-nous au 01 86 26 67 28 et partagez votre projet avec nous ; **ensemble**, nous trouverons une solution adaptée.



Vaisselle de **marque** pour une meilleure hôtellerie

www.dbmark.com

Toute l'information de ce catalogue est incluse dans notre site web.

Nous vous invitons à le visiter et à explorer son contenu ; Vous y trouverez des informations relatives aux prix*, caractéristiques techniques et produits en relation avec votre recherche, ainsi que tous nos catalogues et autres publications digitales.

Table des matières

1	Présentation et buffet _____	7
2	Service de la table _____	75
3	Plateaux _____	151
4	Bar et piscine _____	181
5	Rangement _____	209
6	Cuisine _____	245
7	Transport des aliments _____	295
8	Nettoyage, transport et stockage _____	329
9	Gestion des déchets _____	347
10	Pièces détachées des articles les plus vendus _____	367
11	Index alphanumérique des produits _____	373

Notes

- Prix unitaires et unités par boîtes.
- Les références en gras sont des articles de stock habituel. En cas de rupture de stock, le produit sera fourni dans un délai de 15 à 20 jours.
- Les références qui ne sont pas en gras correspondent à des articles non stockés, sous commandes uniquement. Consultez le délai de mise à disposition auprès du Service Client.

Abréviations des matériaux

ABS	Plastique ABS	MTL	Métal
ACR	Acrylique	PC	Polycarbonate
FV	Fibre de verre	PP	Polypropylène
INOX	Acier inoxydable	PE	Polyéthylène
MEL	Mélatamine	SAN	Plastique SAN

Símbolos:



Répertorié par la NSF



Apte au lave-vaisselle



Lavage à la main
recommandé



Apte au contact
avec aliments



Empilable



Eco-friendly



Sans BPA



Personnalisable



5 ans de garantie
au prorata



Stockez et transportez
les aliments en toute sécurité



Gaz



Électrique



Radiant



Induction



Disponible
en cash&carry

PRÉSENTATION ET BUFFET

1



Les saladiers, les plats et les récipients que nous offrons contribueront à créer un espace de buffet attrayant pour vos clients, au même temps que le bénéfice de la durabilité de nos articles.

De plus, grâce à leurs poids réduits, vos employés valoriseront positivement le fait de travailler avec ces éléments pratiques et légers et pratiques d'utilisation.



1.A

CRISTAL

Collection Mara

Fabriquée en acrylique de grande résistance et simulant le verre. La collection Mara de TableCraft nous offre une magnifique vaisselle avec des pièces traditionnelles, des plats de présentation innovants débordants de glamour et à la fois très résistants.



A1613

Plat rectangulaire
42 x 33 x 2,5 cm



AB14

Bol carré
36 x 36 x 12,5 cm - 6,6 L



Set 3 pièces

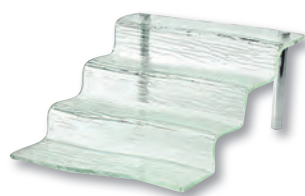

AW4

Présentoir
En escalier 4 étages
38,5 x 30,5 x 16 cm haut.



AW5

Présentoir
En escalier 5 étages
42 x 48,5 x 16,5 cm haut.



ARL3

Présentoir
Set 3 pièces, pieds droits
40,5 x 14 x 2,5 cm / 40,5 x 14 x 7,5 cm / 40,5 x 14 x 12,5 cm



A11

Présentoir
Set 3 pièces demi-lune
54,5 x 28 x 5 cm / 60 x 30,5 x 10 cm / 65 x 33 x 15 cm



Tous les prix sont indiqués en P.V.P. unitaire.



1.B MÉTAL

Collection Remington

Nous hissons l'acier inoxydable à double paroi à un niveau supérieur avec nos magnifiques collections. La Collection Remington confère plus de charme et de polyvalence à des produits d'usages fréquents. Nous proposons des pièces de formes uniques avec des textures martelées qui donneront une touche très élégante à vos présentations.



RB63
Bol rond
16,5 cm Ø x 9,5 cm - 950 ml



● INOX.



RB9
Bol rond
24 cm Ø x 12,5 cm - 3,1 L



● INOX.



RP68
Carafe avec passoire à glaçon
19,5 x 14 x 21,5 cm - 2,3 L



● INOX.



BT2013
Récipient ovale
52 x 33,5 x 22 cm
15 L



● INOX.



R247
Plat rectangulaire
59,5 x 19 cm



● INOX.



RPD2415
Plat rectangulaire
59 x 38 x 2,5 cm



● INOX.



RT3
Présentoir de 3 étages
35,6 / 24,9 / 20,3 cm Ø x 41,5 cm haut.



● INOX.

Tous les articles en **gras** sont des produits de stock habituel. Consulter les couleurs disponibles.

Collection Milano 

Plus de formes et de couleurs élégantes pour mettre en valeur votre table. Ces pièces aussi belles que pratiques complètent toutes présentations et donnent un style sophistiqué à votre buffet.

**ML-77-**

Saladier rond

17,8 cm Ø x 5,7 cm
prof.

710 ml



○ W ● BK

**ML-78-**

Saladier rond

20,3 cm Ø x 5,7 cm
prof.

946 ml



○ W ● BK

**ML-78-RSP**

Saladier rond

20,3 cm Ø x 5,7 cm
prof.

946 ml



● RSP

**ML-79-**

Saladier rond

23,5 cm Ø x 7 cm
prof.

1,4 L



○ W ● BK

**ML-79-RSP**

Saladier rond

23,5 cm Ø x 7 cm
prof.

1,4 L



● RSP

**ML-73-**

Saladier rond

25,4 cm Ø x 7,6 cm
prof.

1,9 L



○ W ● BK

**ML-74-**

Saladier rond

30,5 cm Ø x 7,6 cm
prof.

2,8 L



○ W ● BK

**ML-75-**

Saladier rond

33,7 cm Ø x 8,3 cm
prof.

3,8 L



○ W ● BK

**ML-75-RSP**

Saladier rond

33,7 cm Ø x 8,3 cm
prof.

3,8 L



● RSP

**ML-13-**

Saladier rond

35,6 cm Ø x 7,6 cm
prof.

2,8 L



○ W

**ML-87-**

Saladier rectangulaire

44,5 x 17,1 cm - 1,7 L
5,1 cm prof.

○ W ● BK

**ML-87-RSP**

Saladier rectangulaire

44,5 x 17,1 cm - 1,7 L
5,1 cm prof.

● RSP

**ML-88-**

Saladier rectangulaire

34,9 x 24,1 cm - 2,9 L
6,3 cm prof.

○ W ● BK

Tous les prix sont indiqués en P.V.P. unitaire.



OP-618-

Plat ovale
45,7 x 34,3 cm

 12

W BK



OP-621-

Plat ovale
53,3 x 38,1 cm

 12

W BK



OP-2280-

Plat ovale
57,1 x 20,3 cm

 6

W



ML-14-

Plat ovale
43,2 x 30,5 cm x 3,8 cm
prof.

 6

W



ML-15-

Plat ovale
45,7 x 33 cm x 4,4 cm
prof.

 6

W BK



ML-80-

Assiette ronde
19,1 cm Ø

 12

W BK



ML-81-

Assiette ronde
24,1 cm Ø

 12

W BK



ML-82-

Assiette ronde
26 cm Ø

 12

W BK



ML-83-

Assiette ronde
31,8 cm Ø

 12

W BK



ML-83-RSP

Assiette ronde
31,8 cm Ø

 12

RSP



ML-84-

Assiette ronde
38,1 cm Ø

 6

W BK



ML-60-

Assiette carrée
15,2 cm

 12

W BK



ML-61-

Assiette carrée
18,4 cm

 12

W BK



ML-62-

Assiette carrée
22,2 cm

 12

W BK



ML-63-

Assiette carrée
26 cm

 12

W BK



ML-63-RSP

Assiette carrée
26 cm

 12

RSP



ML-64-

Assiette carrée
29,8 cm

 12

W BK



ML-65-

Assiette carrée
34,9 cm

 6

W BK

Tous les articles en **gras** sont des produits de stock habituel. Consulter les couleurs disponibles.

Collection Siciliano

Élégance du noir et du blanc, lignes douces, marquées et définies pour obtenir une présentation attrayante et contemporaine. Tout comme le reste de la mélamine de G.E.T., elles sont légères, résistantes et aptes au lavage en lave-vaisselle.



ML-257-

Saladier carré

7,6 cm x 3,8 cm prof. 92 ml

 48

W BK



ML-278-

Saladier carré

10,2 cm x 5,1 cm prof. 237 ml

 12

W BK



ML-238-

Saladier carré

12,7 cm x 5,1 cm prof. 426 ml

 12

W BK



ML-245-

Saladier carré

30,5 cm x 10,2 cm prof. 3,9 L

 3

W



ML-279-

Saladier carré

15,2 cm x 5,1 cm prof. 680 ml

 12

W BK

ML-246-

Saladier carré

20,3 cm x 6,3 cm prof. 1,5 L

 6

W BK

ML-247.*

Saladier carré

25,4 cm x 6,3 cm prof. 2,4 L

 6

W BK

ML-281-

Saladier carré

22,9 cm x 6,3 cm prof. 2,2 L

 12

W BK

ML-248.*

Saladier carré

30,5 cm x 10,8 cm prof. 5,4 L

 3

W BK

ML-249.*

Saladier carré

40,6 cm x 12,7 cm prof. 13,2 L

 3

W BK

ML-250-

Saladier carré

45,1 cm x 15,2 cm prof. 19,7 L

 3

W BK



* Autres couleurs disponibles :  ST  KL  SE  OR/BK  BL/BK  G/BK. Vérifiez la disponibilité.

Tous les prix sont indiqués en P.V.P. unitaire.

Collection Siciliano (suite) 



ML-93-

Saladier rond
31,8 cm Ø x 7,6 cm prof.
2,3 L

 6

W BK



ML-95-

Saladier rond
35,6 cm Ø x 8,3 cm prof.
4,3 L

 6

W BK



ML-239-

Saladier rond géant
45,7 cm Ø x 10,8 cm prof.
11,8 L

 3

W BK



ML-241

Saladier rond géant
61 cm Ø x 15,2 cm prof.
25,6 L

 1

W BK



CS-6107-W

Saladier rond
26,7 cm Ø x 3,8 cm prof.
946 ml

 12

W



CS-6106-W

Saladier rond
21,6 cm Ø x 5,7 cm prof.
1,3 L

 12

W



CS-6101-W

Saladier rond
15,9 cm Ø x 5,7 cm prof.
692 ml

 12

W



ML-244-

Plat carré
61 cm x 3,8 cm prof.

 1

W BK



Tous les articles en **gras** sont des produits de stock habituel. Consulter les couleurs disponibles.

ML-252-

Plat ovale
40,6 x 12,7 cm x 2,5 cm
prof.
591 ml



W BK

ML-253-

Plat ovale
53,3 x 16,5 cm x 3,8 cm
prof.
1.2 L



W BK



ML-254-

Plat ovale
63,5 x 20,3 cm x 4,4 cm
prof.
2,5 L



W BK

ML-255-

Plat ovale
68,6 x 25,4 cm x 5,1 cm
prof.
3,8 L



W BK

ML-256-

Plat ovale
76,2 x 29,8 cm x 8,9 cm
prof.
9,8 L



W BK



CS-6103-W

Plat rectangulaire
28,6 x 17,8 cm x 1,9 cm prof.



W



ML-287-

Plat rectangulaire
38,1 x 19,1 cm



W BK



ML-99-

Plat rectangulaire
61 x 45,7 cm



W BK



ML-242-

Plat rectangulaire
71,1 x 40,6 cm x 5,1 cm prof.



W BK



ML-240-

Plat rond
45,7 cm x 3,8 cm prof.



W BK



ML-243-

Plat rond
61 cm x 5,1 cm prof.



W BK



Tous les prix sont indiqués en P.V.P. unitaire.

Collection Siciliano (suite)



ML-102-

Assiette carrée

15,2 x 15,2 cm

12

○ W ● BK

ML-103-

Assiette carrée

20,3 x 20,3 cm

12

○ W ● BK

ML-104-

Assiette carrée

25,4 x 25,4 cm

12

○ W ● BK



ML-90-

Assiette carrée

30,5 x 30,5 cm

6

○ W ● BK

ML-91-

Assiette carrée

35,6 x 35,6 cm

6

○ W ● BK

ML-92-

Assiette carrée

40,6 x 40,6 cm

6

○ W ● BK



CS-6100-W

Assiette rond

19,7 cm Ø

12

○ W

207-5-W

Assiette rond

26,7 cm Ø

12

○ W

CS-6102-W

Assiette rond

30,5 cm Ø

12

○ W

CS-6108-W

Assiette rond

35,6 cm Ø

12

○ W



Saladiers avec anses

Parfaits pour servir des pâtes ou des salades sans effort esferzo.



123468

Saladier noir avec anses

38 x 33 x 12,5 cm - 2,8 L

1

● BK



123469

Saladier noir avec anses

38 x 33 x 12,5 cm - 2,8 L

1

○ W



Tous les articles en **gras** sont des produits de stock habituel. Consulter les couleurs disponibles.

Collection San Michele

Lignes douces et courbes, formes très contemporaines. La ligne San Michele se distingue par son élégance, sa modernité et son design attrayant.



B-791-BK

Saladier rond

27,9 cm Ø x 13,3 cm prof.

4.1 L

 6

● BK



B-791-W

Saladier rond

27,9 cm Ø x 13,3 cm prof.

4.1 L

 6

○ W



B-791-RSP

Saladier rond

27,9 cm Ø x 13,3 cm prof.

4.1 L

 6

● RSP



ML-220-*

Saladier rectangulaire ondulé

26,7 x 41,3 x 15,2 cm

3,8 L

 3

○ W ● BK



ML-219-*

Saladier rectangulaire ondulé

20,7 x 29,2 x 12,7 cm

1,8 L

 3

○ W ● BK



B-797-W*

Saladier ovale cascade

35,6 x 22,2 x 12,7 cm

1,4 L

 6

○ W



B-798-W*

Saladier ovale cascade

50,8 x 25,4 x 15,2 cm

3 L

 6

○ W



ML-233-W

Saladier carré ondulé

7,6 cm x 5,1 cm prof.

121 ml

 12

○ W



ML-232-W

Saladier carré ondulé

18,1 cm x 7,6 cm prof.

1,1 L

 6

○ W



ML-234-W

Saladier carré ondulé

27,9 cm x 11,7 cm prof.

4,4 L

 6

○ W



ML-235-W

Saladier carré ondulé

38,1 cm x 15,9 cm prof.

11 L

 3

○ W

Couleurs disponibles : ○ W

Couleurs sur commande : ● BK y ● RSP

* Autres couleurs disponibles : ● ST ● KL ● SE ● OR/BK ● BL/BK ● G/BK. Vérifiez la disponibilité.

Tous les prix sont indiqués en P.V.P. unitaire.



B-783-

Plat rond cascade
9,5 cm Ø x 5,7 cm prof.
96 ml



○ W ● BK



B-784-

Plat rond cascade
12,1 cm Ø x 7 cm prof.
169 ml



○ W ● BK



B-785-

Plat rond cascade
15,2 cm Ø x 7,6 cm
prof.
296 ml



○ W ● BK



B-786-

Plat rond cascade
16,5 cm Ø x 8,3 cm
prof.
355 ml



○ W ● BK



B-788*

Plat rond cascade
20,3 cm Ø x 8,3 cm
prof.
843 ml



○ W ● BK



B-788-RSP

Plat rond cascade
20,3 cm Ø x 8,3 cm
prof.
843 ml



● RSP



B-792*

Plat rond cascade
23,5 cm Ø x 12,1 cm
prof.
1,2 L



○ W ● BK



B-792-RSP

Plat rond cascade
23,5 cm Ø x 12,1 cm
prof.
1,2 L



● RSP



B-789*

Plat rond cascade
25,4 cm Ø x 12,7 cm
prof.
1,6 L



○ W ● BK



B-789-RSP

Plat rond cascade
25,4 cm Ø x 12,7 cm
prof.
1,6 L



● RSP



B-790*

Plat rond cascade
30,5 cm Ø x 15,9 cm prof.
2,7 L



○ W ● BK



B-790-RSP

Plat rond cascade
30,5 cm Ø x 15,9 cm prof.
2,7 L



● RSP



ML-210-W

Plat feuille
Feuille - 39,4 x 21,6 cm



○ W



ML-211-W

Plat feuille
Feuille - 50,8 x 30,5 cm



○ W

Couleurs disponibles : ○ W

Couleurs sur commande : ● BK y ● RSP

* Autres couleurs disponibles : ● ST ● KL ● SE ● OR/BK ● BL/BK ● G/BK. Vérifiez la disponibilité.

Tous les articles en **gras** sont des produits de stock habituel. Consulter les couleurs disponibles.



Collection Bake & Brew



ML-116-W

Plateau
rectangulaire bord
droit

45,7 x 27,9 cm

6

○ W



ML-294-W

Plateau
rectangulaire bord
droit

30,5 x 22,9 cm

6

○ W



ML-179-BK

Plateau
rectangulaire bord
droit

29,7 x 20 cm

12

● BK



ML-109-

Plateau
rectangulaire bord
droit

26 x 48,3 cm

3

○ W ● BK



ML-110-

Plateau
rectangulaire bord
droit

30,5 x 53,3 cm

3

○ W ● BK



ML-111-

Plateau
rectangulaire bord
droit

33 x 54 cm

3

○ W ● BK



ML-128-

Plateau
rectangulaire bord
ondulé

34,3 x 13,3 x 2,5 cm
prof.

12

○ W ● BK



ML-112-

Plateau
rectangulaire bord
ondulé

48,3 x 13,3 x 2,5 cm
prof.

12

○ W ● BK



ML-129-W

Plateau
rectangulaire bord
ondulé

53,3 x 13,3 x 2,5 cm
prof.

12

○ W



ML-113-

Plateau
rectangulaire bord
ondulé

58,4 x 13,3 x 2,5 cm
prof.

12

○ W ● BK



ML-154-

Plateau
rectangulaire bord
ondulé

35,6 cm x 14 cm x
3,2 cm prof.

6

○ W ● BK



ML-155-

Plateau
rectangulaire bord
ondulé

35,6 x 29,2 x 3,2 cm
prof.

6

○ W ● BK

Tous les prix sont indiqués en P.V.P. unitaire.

Collection Frostone

La Collection Frostone apporte élégance à votre table. Deux textures disponibles : rayée et galet.



M165

Plat rectangulaire
texture rayée

40 x 12 x 2,5 cm



○ w

M186

Plat rectangulaire
texture rayée

45 x 14 x 2,5 cm



○ w

M206

Plat rectangulaire
texture rayée

51 x 16 x 2,5 cm



○ w

M2010

Plat rectangulaire
texture rayée

49,5 x 26,5 x 3 cm



○ w

M2511

Plat rectangulaire
texture rayée

63 x 26 x 4 cm



○ w

M2811

Plat rectangulaire
texture rayée

70 x 26,5 x 5 cm



○ w



M2213

Plat rectangulaire
texture rayée

56 x 32,5 x 5,5 cm



○ w

M14

Plat rectangulaire
texture rayée

36,5 x 36,5 x 4,5 cm



○ w

M18

Plat rond
texture de galet

46 x 46 x 1,5 cm



○ w

M22

Plat rond
texture de galet

55 x 55 x 5,5 cm



○ w

MPD2415

Plat rectangulaire
texture de galet

52,5 x 32,5 x 4,5 cm



○ w



MBT126

Bol incliné texture
rayée

35,5 x 31,5 x 14,5 cm
2,6 L



○ w

WB7

Bol ondulé

18,5 Ø x 8,5 cm
1,2 L



○ w

WB9

Bol ondulé

21,5 Ø x 9,5 cm
1,8 L



○ w

WB13

Bol ondulé

32,5 Ø x 16,5 cm
6,4 L



○ w

WB16

Bol ondulé

40 Ø x 17,5 cm
10,6 L



○ w

Tous les articles en **gras** sont des produits de stock habituel. Consulter les couleurs disponibles.



1.D COULEUR

■ Colecciones Keywest et Brasilia

Colorées, voyantes, élégantes et très résistantes. Les gammes Key West et Brasilia vous aideront à améliorer la qualité et la présence de vos salades et de vos desserts. Comme toute la mélamine de G.E.T., elles sont légères, résistantes et aptes au lavage au lave-vaisselle.



B-797-

Saladier ovale cascade
35,6 x 22,2 cm x 12,7 cm prof.
1,4 L
6



B-798-

Saladier ovale cascade
50,8 x 25,4 cm x 15,2 cm prof.
3 L
6



B-788-

Saladier ovale cascade
20,3 cm Ø x 8,3 cm prof.
843 ml
6



B-792-

Saladier ovale cascade
23,5 cm Ø x 12,1 cm prof.
1,2 L
6



B-789-

Saladier ovale cascade
25,4 cm Ø x 12,7 cm prof.
1,6 L
6



B-790-

Saladier ovale cascade
30,5 cm Ø x 15,9 cm prof.
2,7 L
6

Couleurs disponibles : ● ST ● KL ● SE ● OR/BK ● BL/BK ● G/BK. Vérifiez la disponibilité.

Tous les prix sont indiqués en P.V.P. unitaire.



ML-219-

Saladier ondulé

20,7 x 29,2 cm x 12,7 cm prof.
1,8 L



ML-220-

Saladier ondulé

26,7 x 41,3 cm x 15,2 cm prof.
3,8 L



ML-247-

Saladier carré

25,4 x 25,4 cm x 6,3 cm prof.
2,4 L



ML-248-

Saladier carré

30,5 x 30,5 cm x 10,8 cm prof.
5,7 L



ML-249-

Saladier carré

40,6 x 40,6 cm x 12,7 cm prof.
13,2 L



Couleurs disponibles : ● ST ● KL ● SE ● OR/BK ● BL/BK ● G/BK. Vérifiez la disponibilité.

Rejoignez-nous



@DbmarkTweet



@dbmarkhosteleria



@dbmark_inst

Tous les articles en **gras** sont des produits de stock habituel. Consulter les couleurs disponibles.

Collection Santa Lucía 

Surprenez vos convives avec ce design attrayant pour vos buffets. Toutes nos pièces offrent des tailles généreuses.

**OP-618**

Plat ovale
45,7 x 34,3 cm

**OP-621**

Plat ovale
53,3 x 38,1 cm

**OP-630**

Plat ovale
76,2 x 51,4 cm

**ML-90**

Assiette carrée
30,5 x 30,5 cm

**ML-91**

Assiette carrée
35,6 x 35,6 cm

**ML-92**

Assiette carrée
40,6 x 40,6 cm

**ML-87**

Saladier rectangulaire
44,5 x 17,1 x 5,1 cm
1,7 L

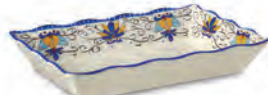
**ML-88**

Saladier rectangulaire
34,9 x 24,1 x 6,3 cm
2,9 L



Tous les prix sont indiqués en P.V.P. unitaire.



ML-93

Saladier rond

31,8 cm Ø x 7,6 cm prof.

2,3 L



ML-94

Saladier rond

34,3 cm Ø x 8,3 cm prof.

3,6 L



ML-95

Saladier rond

35,6 cm Ø x 8,3 cm prof.

4,3 L



Image reproduite avec l'aimable autorisation de Catering EL CANDIL (Sevilla)

Tous les articles en **gras** sont des produits de stock habituel. Consulter les couleurs disponibles.



Collection Lunara

Finition exclusive, marron mate, tâches cuivrées et motif texturé, les pièces de cette collection ont une grande similitude avec les pièces en céramique de grande qualité, ajouté à la résistance de la mélamine. Empilable pour un rangement plus aisé. Parfaite pour servir vos plats ou des portions plus grandes pour vos buffet ou caterings. Convient aussi bien pour des dîners décontractés que pour des banquets plus élégants.



12351506

Assiette ronde

27,3 cm Ø



123517BR

Assiette ronde

35,5 cm Ø



123518BR

Assiette ronde

40,5 cm Ø



123519BR

Assiette ronde

45,5 cm Ø



Collection Lindenwood

Ajoutez une touche champêtre à votre table ou buffet avec nos nouveaux plateaux ou sous-plats en mélamine. Le cerne et la texture imitent le tronc naturel et offre hauteur et relief aux présentations.



10253

Sous-plat

24 cm Ø x 2,5 cm haut.



10254

Sous-plat

28 cm Ø x 2,5 cm haut.



10255

Sous-plat

33 cm Ø x 2,5 cm haut.



Tous les prix sont indiqués en P.V.P. unitaire.

Collection Frostone Acacia

La Collection Frostone Acacia combine l'apparence naturelle du bois d'acacia avec la qualité et la légèreté de la mélamine.



MB94ACA

Saladier carré

25,5 x 25,5 x 10,5 cm - 3,5 L



MB125ACA

Saladier carré

31,5 x 31,5 x 12,5 cm - 6,4 L



MB166ACA

Saladier carré

40 x 40 x 14,5 cm - 15,1 L



Collection Barnwood

Disponible dans une large variété de formes et de tailles, ces pièces ajoutent une touche casual à vos présentations. Facile à nettoyer et apte au lave-vaisselle.



10016

Planche ronde avec manche

32 cm Ø - 42 cm avec manche



10017

Planche rectangulaire avec manche

20 x 25 cm - 30,5 cm avec manche



10018

Planche rectangulaire

25,5 x 19,5 cm



10019

Plat rectangulaire

28 x 14,5 cm



Rejoignez-nous



@DbmarkTweet



@dbmarkhosteleria



@dbmark_inst

Tous les articles en **gras** sont des produits de stock habituel. Consulter les couleurs disponibles.



Collection tri-ply cookware

La distribution uniforme de la chaleur est garantie grâce à la fabrication de trois couches d'acier inoxydable et aluminium. Aptes pour les températures jusqu'à 260 °C et pour l'induction.



CW2030BK | CW2030R

Faitout rectangulaire

33,5 x 24,5 x 11 cm
4 L



CW2032BK | CW2032R

Faitout rectangulaire
(pas induction)

41 x 29,5 x 11 cm
6,8 L



CW7002BK | CW7002R

Faitout mini rond

25 x 17 x 10 cm
2,3 L



CW7004BK | CW7004R

Faitout rond

27,5 x 19,5 x 11,5 cm
3,4 L



CW7010BK | CW7010R

Faitout rond bas

33,5 x 25,5 x 6,5 cm
3,4 L



*Résistance à la chaleur
jusqu'à 260 °C*

Anses ergonomiques pour un transport aisé



Aussi bien pour l'induction que pour le four traditionnel

Revêtement durable disponible en rouge ou noir.

Tous les prix sont indiqués en P.V.P. unitaire.

Plat à pizza

Plats à pizzas para pizza en fonte d'aluminium.



CW4140N

Plat à pizza

17,5 cm de diamètre et manche de 8,5 cm



CW4100N

Plat à pizza

40,5 cm de diamètre et manche de 18 cm



Aluminium fondu

Conçus avec un revêtement intérieur anti-adhérent et un revêtement extérieur préparé pour supporter les hautes températures. Aptes pour les températures jusqu'à 230 °C, compatible induction.



Résistance à la chaleur jusqu'à 230 °C



CWDC1040

Wok avec couvercle

39,5 x 33 x 19 cm
3,4 L



CWDC1050

Casserole avec couvercle

32 x 25 x 16,5 cm
3,4 L



CWDC1030

Casserole avec couvercle

32 x 25,5 x 20,5 cm
5,7 L



CWDC1070

Placha rectangulaire

45,5 x 27,5 x 5,5 cm



Tous les articles en **gras** sont des produits de stock habituel. Consulter les couleurs disponibles.

Saladiers Deli Crock

Fabriqués en SAN, les récipients Deli Crock de CAMBRO sont très utiles pour présenter les aliments en vitrines réfrigérées. Récipients et couvercles disponibles en blanc, noir, rouge et transparent.

**DC5**

Saladier rectangulaire
17,5 x 26 x 8 cm - 2 L



○ 152 ○ 148 ● 110 ● 404

**DC10**

Saladier rectangulaire
26,5 x 33,5 x 8 cm - 4,6 L



○ 152 ○ 148 ● 110 ● 404

**DP15**

Saladier ovale
40 x 30,5 x 5,5 cm - 3,2 L



○ 152 ○ 148 ● 110 ● 404

**DCC5**

Couvercle rectangulaire
Pour DC5 - 23,8 x 14,9 x 3,7 cm - 0,9 L

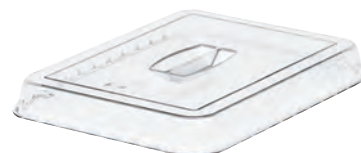

○ 135

**DCC10**

Couvercle rectangulaire
Pour DC10 - 31 x 24 x 3,7 cm - 1,9 L



○ 135



Évitez la contamination croisée et conservez la nourriture fraîche avec le couvercle transparent à poignée.



Le couvercle peut être utilisé comme support supplémentaire sur les tables des buffets.



Le couvercle sert également de faux fond pour réduire la taille du récipient.

Tous les prix sont indiqués en P.V.P. unitaire.

Saladiers Showfest

Fabriqués par thermo-moulage, les récipients Showfest disposent de différentes formes et tailles permettant de s'adapter aux vitrines d'exposition en magasin ou pour compléter un buffet de salades.



SFG1012

Saladier octogonal
25,4 x 30,5 x 5 cm - 2,8 L



● 110



SFG1015

Saladier octogonal
25,4 x 38 x 5 cm - 3,5 L



● 110



SFG820

Saladier octogonal
20,3 x 50,8 x 5 cm - 3,7 L



● 110



SFG1220

Saladier octogonal
30,5 x 50,8 x 5 cm - 5,8 L



● 110



SFT1010

Saladier triangulaire
25,4 x 30,5 x 6,4 cm
1,9 L



● 110



SFT1212

Saladier triangulaire
30,5 x 38 x 6,4 cm
2,8 L



● 110



SFT1515

Saladier triangulaire
38 x 50,8 x 6,4 cm
4,2 L



● 110



SFV1015

Saladier ovale
festonné
25,4 x 38 x 5 cm
2,8 L



● 110



SFR1012

Saladier rectangulaire
festonné
25,4 x 31,8 x 7,6 cm
4,3 L



● 110

Saladiers en ABS et fibre de verre

Les saladiers SB bénéficient du meilleur rapport prix/résistance et s'ajustent aux budgets serrés. Les saladiers en fibre de verre sont l'option hygiénique à l'utilisation de récipients en bois.



SB55

Saladier en ABS
14,5 cm - 325 ml



● 174 ● 110



SB60

Saladier en ABS
15,2 cm - 375 ml



● 174 ● 110



SB80

Saladier en ABS
20,3 cm - 925 ml



● 174 ● 110



6F

Saladier en fibre
de verre
15,6 cm Ø - 425 ml



● 301



8F

Saladier en fibre
de verre
20,3 cm Ø - 925 ml



● 301

Tous les articles en **gras** sont des produits de stock habituel. Consulter les couleurs disponibles.

1.H

RÉCIFIENTS

Récipients GN de mélamine

Utilisez les récipients en mélamine Gastronorm pour vos présentations, en combinant différentes couleurs. Recommandés pour l'exposition au froid. Conçus pour s'adapter aux espaces standard de 30,5 x 50,8 cm.



MG2420

Récipient GN 2/4
53 x 16 x 2 cm
20 mm prof.



WH BK

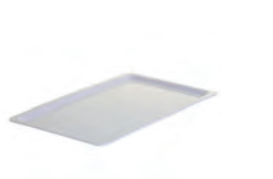

MG1120

Récipient GN 1/1
53 x 32,5 x 2 cm
20 mm prof.



WH BK



MG1165

Récipient GN 1/1
53 x 32,5 x 6,5 cm
65 mm prof.



WH BK



MG11100

Récipient GN 1/1
53 x 32,5 x 10 cm
100 mm prof.



WH BK R



MG1265

Récipient GN 1/2
32 x 26 x 6,5 cm
65 mm prof.



WH BK



MG12100

Récipient GN 1/2
32,5 X 26,5 x 10 cm
100 mm prof.



WH BK R



MG1365

Récipient GN 1/3
32 x 18 x 6,5 cm
65 mm prof.



WH BK



MG13100

Récipient GN 1/3
33 x 18 x 10 cm
100 mm prof.



WH BK R



MG1465

Récipient GN 1/4
26 x 16 x 6,5 cm
65 mm prof.



WH BK

Rejoignez-nous



@DbmarkTweet



@dbmarkhosteleria



@dbmark_inst

Tous les prix sont indiqués en P.V.P. unitaire.



■ Récipients cotés droit en mélamine

Récipient avec coupe latérale droite pour une utilisation optimale de l'espace. Grande gamme de tailles et de couleurs voyantes, parfaites pour l'environnement scolaire – Pièces durables et résistantes à la casse, idéales pour une utilisation prolongée.



M4024

Récipient côtés droits
12,5 x 12,5 x 7,5 cm



● BK ○ WH ● R ● X ● Y ● LG



M4026

Récipient côtés droits
25,5 x 12,5 x 7,5 cm



● BK ○ WH ● R ● X ● Y ● LG



M4014

Récipient côtés droits
25,5 x 25,5 x 4 cm



● BK ○ WH ● R ● X ● Y ● LG



M4008

Récipient côtés droits
38 x 12,5 x 7,5 cm



● BK ○ WH ● R ● X ● Y ● LG



M4004

Récipient côtés droits
25,5 x 25,5 x 7,5 cm



● BK ○ WH ● R ● X ● Y ● LG



M4007

Récipient côtés droits
38 x 12,5 x 4 cm



● BK ○ WH ● R ● X ● Y ● LG

Tous les articles en **gras** sont des produits de stock habituel. Consulter les couleurs disponibles.

■ Récipients réfrigérés Cold Fest

Bacs et pots parfaits pour présenter des salades et des crèmes froides. Fabriqués en plastique ABS, ils disposent de parois isothermes froides qui, une fois hors de la chambre froide, gardent les produits au frais pendant des heures.

- Gardez les aliments au froid selon les critères de l'APCC à 4 °C ou en dessous.
- Congelez pendant 8 heures ou toute la nuit avant de les remplir avec un produit pré-réfrigéré.



26CF
Récipient GN1/2

15 cm prof.
6 L



○ 148 ● 110



36CF
Récipient GN1/3

15 cm prof.
3,5 L



○ 148 ● 110



66CF
Récipient GN1/6

15 cm prof.
1,4 L



○ 148 ● 110



CFR18
Récipient rond

17,3 cm Ø - 17 cm prof.
1,6 L



○ 148 ● 110



20CFC
Couvercle plat pour 26CF



○ 135



30CFC
Couvercle plat pour 36CF



○ 135



60CFC
Couvercle plat pour 66CF



○ 135



CFRC18
Couvercle plat pour CFR18



○ 135



CFRSC18
Couvercle étanche

Pour CFR18



○ 148



CFPSRC10
Couvercle avec pompe standard
Pour portions de 29,5ml
22,8 x 18,4 x 28,5 cm



○ 135



CFPMRC10
Couvercle avec pompe maxi
Condiments et morceaux
26 x 18,4 x 31,4 cm



○ 135



CFPFRC10
Couvercle avec pompe
Bec fixe et débit réglé
29,5 x 18,4 x 29,8 cm



○ 135

Tous les prix sont indiqués en P.V.P. unitaire.



1.1

PRÉSENTOIRS

Présentoirs et planches en mélamine

Pour présenter canapés, petits-fours, verrines ou autres desserts miniatures, les meilleures options restent les présentoirs ou les planches de présentation, qui peuvent être placés directement sur la table ou à différentes hauteurs à l'aide des socles de présentation. Fabriqués en mélamine haute gamme, ils imitent l'ardoise, la pierre ou le bois.



MG1

Présentoir plat rectangulaire
Frostone

GN 1/1
53 x 32,5 x 1 cm

3

● BS



MG2

Présentoir plat rectangulaire
Frostone

GN 1/2
32,5 x 26,5 x 1 cm

3

● BS



MGL2

Présentoir plat rectangulaire
Frostone

GN 2/4
53 x 16 x 1 cm

3

● BS



MG3

Présentoir plat rectangulaire
Frostone

GN 1/3
32,5 x 17,5 x 1 cm

6

● BS



Tous les articles en **gras** sont des produits de stock habituel. Consulter les couleurs disponibles.



MG13

Présentoir plat rond Frostone

33 cm Ø x 1 cm

3

● BS



MG16

Présentoir plat rond Frostone

40,5 cm Ø x 1 cm

3

● BS



MGD2112

Présentoir en mélamine en relief imitation ardoise

Rectangulaire - 53,5 x 32,5 x 3 cm

3

● BS



MGD1616

Présentoir en mélamine en relief imitation ardoise

Carré - 42 x 42 x 3 cm

3

● BS



MGD16

Présentoir en mélamine en relief imitation ardoise

Rond - 41,5 x 41,5 x 1 cm

3

● BS



Tous les prix sont indiqués en P.V.P. unitaire.

■ Présentoirs et planches en mélamine (suite)



MG1DW

Présentoir plat rectangulaire Frostone imitation bois gris

GN 1/1

53 x 32,5 x 1 cm



● DW



MG2DW

Présentoir plat rectangulaire Frostone imitation bois gris

GN 1/2

32,5 x 26,5 x 1 cm



● DW



MG3DW

Présentoir plat rectangulaire Frostone imitation bois gris

GN 1/3

32,5 x 17,5 x 1 cm



● DW

MGL2DW

Présentoir plat rectangulaire Frostone imitation bois gris

GN 2/4

53 x 16 x 1 cm



● DW



MG13DW

Présentoir plat rond Frostone imitation bois gris

33 cm Ø x 1 cm



● DW



MELAMINE



AVANTAGES

C'est un matériau pratiquement incassable
Résistant aux rayures et à l'acide

Résiste aux températures de -30 °C à 70 °C
La température ne sera pas une préoccupation

Léger et versatile
Usage plus aisé

Empilable et apte au lavage au lave-vaisselle
Vous économiserez de l'espace de rangement

Capable d'imiter tous les matériaux,
uniquement trahi par le toucher
Grande variété de formats, volumes et styles

PRÉCAUTIONS

Traiter la vaisselle en mélamine comme la vaisselle de qualité



N'utiliser que des fibres plastiques non abrasives
pour le nettoyage



Ne pas utiliser de couteaux édentés



Éviter l'utilisation de produits nettoyant à base de chlore



Ne pas mettre au micro-ondes

Tous les articles en **gras** sont des produits de stock habituel. Consulter les couleurs disponibles.



MG1WM

Présentoir plat Frostone imitation marbre blanc

GN 1/1

53 x 32,5 x 1 cm

3

WM



MG2WM

Présentoir plat rectangulaire Frostone imitation marbre blanc

GN 1/2

32,5 x 26,5 x 1 cm

3

WM



MG3WM

Présentoir plat rectangulaire Frostone imitation marbre blanc

GN 1/3

32,5 x 17,5 x 1 cm

6

WM



MGL2WM

Présentoir plat rectangulaire Frostone imitation marbre blanc

GN 2/4 - 53 x 16 x 1 cm

3

WM



MG13WM

Présentoir plat rond Frostone imitation marbre blanc

33 cm Ø x 1 cm

4

WM



Tous les prix sont indiqués en P.V.P. unitaire.

■ Présentoirs et planches en mélamine (suite) 



SB-1010-OW
Planche imitation chêne
Carrée - 25 x 25 cm

 6

 OW

SB-1210-OW
Planche imitation chêne
Rectangulaire - 30 x 25 cm

 6

 OW

SB-1472-OW
Planche imitation chêne
Rectangulaire - 36 x 18 cm

 6

 OW

SB-2010-OW
Planche imitation chêne
Rectangulaire - 51 x 25 cm

 3

 OW



SB-1155-OW
Planche imitation chêne
Rectangulaire - 28 x 14 cm,
38 cm avec manche

 12

 OW

SB-775-OW
Planche imitation chêne
Ronde - 19,6 cm Ø,
27,3 cm avec manche

 12

 OW

SB-1375-COW
Planche réversible rectangulaire
Rectangulaire - 34 x 20 cm,
46 cm avec manche

 12

 COW



SB-2005-W
Planche imitation bois de noyer
Rectangulaire - 51 x 14 cm

 6

 W

SB-2011-W
Planche imitation bois de noyer
Rectangulaire - 51 x 28 cm

 3

 W

SB-1409-ACW
Planche imitation bois d'acacia avec anses
Rectangulaire - 36 x 22 cm

 6

 ACW

Tous les articles en **gras** sont des produits de stock habituel. Consulter les couleurs disponibles.



■ Planches en bois - Collection Acacia

Ces pièces permettent de présenter vos apéritifs, canapés, entrées d'une manière originale, avec un charmant look rustique.



Ne pas laisser tremper



ACARD099

Disque rond et ovale
en bois d'acacia
23 cm Ø x 2 cm



ACARD1212

Disque rond et ovale
en bois d'acacia
30,5 cm Ø x 2 cm



ACAV1608

Disque rond et ovale
en bois d'acacia
40,5 x 20,5 x 2 cm



ACAV2008

Disque rond et ovale
en bois d'acacia
51 x 20,5 x 2 cm



ACAR1208

Planche rectangulaire en bois d'acacia
30,5 x 20,5 x 2 cm



ACAR1409

Planche rectangulaire en bois d'acacia
35 x 24 x 2 cm



ACAR1812

Planche rectangulaire en bois d'acacia
45,5 x 30 x 2 cm



Tous les prix sont indiqués en P.V.P. unitaire.

■ Planches en bois - Collection Acacia (suite)



ACAPB2006

Planche en bois d'acacia

51 x 15 x 1,5 cm



ACAPB2208

Planche en bois d'acacia

56 x 20,5 x 2 cm



ACABB1409

Planche irrégulière en bois d'acacia

35,5 x 23 x 2 cm



ACABB1610

Planche irrégulière en bois d'acacia

40,5 x 25,5 x 2 cm



ASHR1410

Planche ronde en bois de frêne

35,5 x 25,5 x 1,5 cm



ASHR1612

Planche ronde en bois de frêne

40,5 x 30,5 x 1,5 cm



ASHR1814

Planche ronde en bois de frêne

45,5 x 25,5 x 1,5 cm



Tous les articles en **gras** sont des produits de stock habituel. Consulter les couleurs disponibles.



■ Planches en bois - Collection Acacia (suite)

 Ne pas laisser tremper



ACARD14

Planche ronde quadrillé
en bois d'acacia
35,5 cm Ø x 4 cm

 1



ACARD16

Planche ronde quadrillé
en bois d'acacia
40,5 cm Ø x 4 cm

 1



ACAMBB1206

Planche en bois d'acacia
avec œillet métallique
30,5 x 16 x 1,5 cm

 1



ACAMBB1507

Planche en bois d'acacia
avec œillet métallique
38 x 18,5 x 1,5 cm

 1



ACAMR1606

Planche rectangulaire
en bois d'acacia avec anses
métalliques
42,5 x 15,5 x 3 cm

 1



ACAMR2007

Planche rectangulaire
en bois d'acacia avec anses
métalliques
50 x 18 x 3 cm

 1



ACAMR10

Planche ronde en bois
d'acacia avec anse métallique
33 x 25,5 x 1,5 cm

 1



ACAMR14

Planche ronde en bois
d'acacia avec anse métallique
43 x 35,5 x 1,5 cm

 1

Tous les prix sont indiqués en P.V.P. unitaire.



Collection Industrielle

Modernisez vos buffets ou présentations avec cette collection qui combine bois et métal. Le bois offre une texture chaude et terreuse, tandis que les manches et rivets métalliques ajoutent de la modernité. Parfait pour servir hors-d'œuvre, entrées ou encore desserts.



bois naturel



10076

Planche rectangulaire avec manche
21 x 23 cm, manche de 12 cm



10077

Planche rectangulaire avec manche
31 x 18 cm, manche de 12 cm



10078

Planche rectangulaire avec manche
38,5 x 21,5 cm, manche de 12 cm



10079

Planche ronde avec manche
25,5 cm Ø, manche de 12 cm



10080

Planche ronde avec manche
30,5 cm Ø, manche de 12 cm



10081

Planche ronde avec manche
35,5 cm Ø, manche de 12 cm



Tous les articles en **gras** sont des produits de stock habituel. Consulter les couleurs disponibles.



■ Planches en bois réversibles

Une alternative amusante pour servir des dégustations de bières, cocktails ou apéritifs. Réversible, côté creux rond, côté creux carrés. Pourvue d'une fente pour étiqueter vos assortiments.



FLIGHT1

Planche réversible couleur bambou
43 x 10 x 1,5 cm - pour 4 verres*



*Verres non inclus



FLIGHT2

Planche réversible couleur acacia
43 x 10 x 1,5 cm - pour 4 verres*



FLBEER4

Verre pour planche réversible
Set de 4 Masont jar - 7,5 x 5,5 x 8,5 cm
135 ml



6



FLGLASS4

Verre pour planche réversible
Set de 4 verres vintage - 6 x 6 x 7 cm
120 ml



6



Tous les prix sont indiqués en P.V.P. unitaire.



■ Socles de Présentation

Mettez en valeur vos plats et assortiments avec les socles de présentation. Gagnez de l'espace et améliorez la qualité de vos présentations.



RR3

Socle cylindrique en acier inoxydable

Set 3 pièces :
20,5 cm Ø x 23 cm haut.
18 cm Ø x 15 cm haut.
15 cm Ø x 8 cm haut.



● INOX.



RS3

Socle carré en acier inoxydable

28 cm
18 cm
13 cm



● INOX.



CR3

Socle carré en fer chromé

Set 3 pièces :
S: 15 x 15 x 5 cm
M: 15 x 15 x 7,5 cm
L: 15 x 15 x 10 cm



chromé

BKP4

Piédestal rond en acier recouvert de métal poudre noire

Support quatre étages,
22,9 cm de diamètre.
28 x 23 x 37 cm



BKR4

Piédestal rectangulaire en acier

Set 4 pièces :
S : 18 x 15 x 5 cm
M : 18 x 15 x 7,5 cm
L : 18 x 15 x 10 cm
XL : 18 x 15 x 15 cm



Tous les articles en **gras** sont des produits de stock habituel. Consulter les couleurs disponibles.



■ Caisses en bois Gastronom

Un choix de haute qualité qui apporte une sensation de rustique et à la fois contemporaine à vos présentations. Dotées de poignées pour un usage confortable.

 Ne pas laisser tremper



CRATE11

Caisse en bois d'acacia

GN 1/1
53 x 32,5 x 7 cm

 1

 AW



CRATE114

Caisse en bois d'acacia

GN 1/1
52,5 x 32,5 x 11 cm

 1

 AW



CRATE116

Caisse en bois d'acacia

GN 1/1
52,5 x 32,5 x 16 cm

 1

 AW



CRATE12

Caisse en bois d'acacia

GN 1/2
32,5 x 26,5 x 7 cm

 1

 AW



CRATE124

Caisse en bois d'acacia

GN 1/2
32,5 x 26,5 x 11 cm

 1

 AW



CRATE126

Caisse en bois d'acacia

GN 1/2
32,5 x 26,5 x 16 cm

 1

 AW



CRATE13

Caisse en bois d'acacia

GN 1/3
32,5 x 17,5 x 7 cm

 1

 AW



CRATE134

Caisse en bois d'acacia

GN 1/3
32,5 x 17,5 x 11 cm

 1

 AW



CRATE136

Caisse en bois d'acacia

GN 1/3
32,5 x 17,5 x 16 cm

 1

 AW



CRATE14

Caisse en bois d'acacia

GN 1/4
26,5 x 16,5 x 7 cm

 1

 AW

Tous les prix sont indiqués en P.V.P. unitaire.

Housse en silicone pour bacs Gastronorm

Ces housses en silicone sont idéales pour le stockage et le transport de nos bacs Gastronorm et demi Gastronorm. Elles permettent d'identifier facilement le contenu du récipient et sont très flexibles.

10776

Housse bac GN 1/1

52 x 31,5 x 4,5 cm



10777

Housse bac GN 1/2

32,5 x 26,5 x 4,5 cm

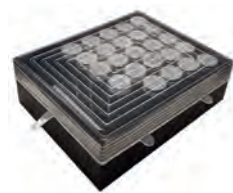

Caisses en bois Gastronorm (suite)



CRATE11W

Caisse en bois blanche

GN 1/1

52,5 x 32,5 x 16 cm



CRATE12W

Caisse en bois blanche

GN 1/2

32,5 x 26,5 x 16 cm



CRATE13W

Caisse en bois blanche

GN 1/3

32,5 x 17,5 x 16 cm



CRATE14W

Caisse en bois blanche

GN 1/4

26,5 x 16,5 x 7 cm



Tous les articles en **gras** sont des produits de stock habituel. Consulter les couleurs disponibles.

■ Caisses en bois Gastronorm (suite)



CRATE11BK

Caisse en bois noire

GN 1/1

53 x 32,5 x 7 cm



● BPW

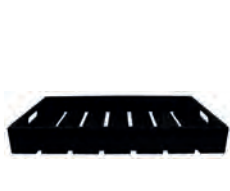

CRATE114BK

Caisse en bois noire

GN 1/1

52,5 x 32,5 x 11 cm



● BPW



CRATE116BK

Caisse en bois noire

GN 1/1

52,5 x 32,5 x 16 cm



● BPW



CRATE12BK

Caisse en bois noire

GN 1/2

32,5 x 26,5 x 7 cm



● BPW



CRATE124BK

Caisse en bois noire

GN 1/2

32,5 x 26,5 x 11 cm



● BPW



CRATE126K

Caisse en bois noire

GN 1/2

32,5 x 26,5 x 16 cm



● BPW



CRATE13BK

Caisse en bois noire

GN 1/3

32,5 x 17,5 x 7 cm



● BPW



CRATE134BK

Caisse en bois noire

GN 1/3

32,5 x 17,5 x 11 cm



● BPW



CRATE136BK

Caisse en bois noire

GN 1/3

32,5 x 17,5 x 16 cm



● BPW



CRATE14BK

Caisse en bois noire

GN 1/4

26,5 x 16,5 x 7 cm



● BPW

ENTRETIEN DU BOIS



- Traiter le bois avec de l'huile de cuisine ou de la vaseline liquide. Une fois sec, rincer à l'eau tiède.
- Retirer les mauvaises odeurs et désinfecter. Il est recommandé d'étaler du sel et avec un demi-citron frotter la surface de façon circulaire puis rincer. Pour enlever les taches, utilisez de l'eau oxygénée, et ensuite traiter le bois avec de l'huile ou de la vaseline.
- Lavage après utilisation avec des aliments. Après avoir enlevé les restes de nourriture, rincez le bois avec de l'eau froide pour qu'il ne se tache pas et égouttez. Séchez le bois rapidement. Une fois presque sec, passer un peu d'huile avec un torchon, laissez sécher et ranger.
- Il n'est pas recommandé que les articles en bois soient exposés au soleil pendant de longues périodes.
- Ne pas laver ou traiter le bois d'un seul côté. Lors du traitement, du lavage ou du rinçage, il est conseillé de réaliser ces actions sur les deux faces pour garantir un traitement homogène.
- Première utilisation. Traiter le bois avant la première utilisation afin d'empêcher l'humidité, les champignons et les bactéries de pénétrer dans les fibres du bois. Il est important de laver la planche à l'eau chaque fois que vous l'utilisez pour éviter entre autres de contaminer les aliments avec les fortes saveurs des aliments précédents.

Tous les prix sont indiqués en P.V.P. unitaire.



■ Caisses en bois recyclées en bois recyclé

Jolies caisses en bois recyclé qui donneront une touche originale à votre buffet. Disponible en trois tailles. Elles peuvent s'utiliser aussi bien comme rangement que sous forme de présentoir et ainsi mettre en valeur produits.



WB-1-SET-RWD

Caisses en bois avec anses en corde

Set de 3 caisses:

- Petite : 29,8 cm x 21 cm, 20 cm haut..
- Moyenne : 39 cm x 32 cm, 21 cm haut.
- Grande : 39 cm x 37 cm, 23 cm haut.

1

● RW



WB-1616-RWD

Caisses en bois avec anses en corde

Boîte carrée, 39 cm, 8,5 cm haut.

1

35,96 €

1

● RW



■ Caisses en bois rustiques

Caisses en bois d'aspect rustique pour donner une touche vintage à vos buffets. Disponible en trois tailles et deux modèles : bois naturel et blanc décapé. Pour rangement ou comme présentoir pour ajouter de la hauteur à vos présentations. Intègre une ardoise pratique pour étiqueter ou bien décorer.



RCBCRATE1

Caisse en bois rustique

Set de caisses en bois naturel :

- Petite : 35 x 25,5 x 18 cm
- Moyenne : 40,5 x 30 x 23,5 cm
- Grand : 49 x 34,5 x 26,5 cm

1

● NW

RCBCRATE2

Caisse en bois rustique

Set de caisses blanches décapées :

- Petite : 35 x 25,5 x 18 cm
- Moyenne : 40,5 x 30 x 23,5 cm
- Grand : 49 x 34,5 x 26,5 cm

1

● DW



Tous les articles en **gras** sont des produits de stock habituel. Consulter les couleurs disponibles.

■ Socles en bois

ocles et pots originaux en bois de bambou eco-friendly. Utiles pour élever vos plateaux en buffet tout en stockant à l'intérieur des serviettes, des sachets de sucres, des couverts, etc. Avec une Surface en ardoise pratique pour spécifier son contenu. Différentes hauteurs pour une utilisation combinée et réaliser des effets élégants.



RCBR555

Socle pot rond

12,5 x 12,5 x 13,5 cm



RCBR668

Socle pot rond

15,5 x 15,5 x 19 cm



RCBR9910

Socle pot rond

21,5 x 21,5 x 25 cm



RCBS445

Socle pot carré

11,5 x 11,5 x 14 cm



RCBS1387

Socle pot rectangulaire

32 x 21,5 x 18,5 cm



■ Mini support pliant pour table

Une manière moderne, amusante de servir des entrées, des apéritifs ou des pizzas offrant plus d'espace sur la table. Stable, supporte la chaleur, antidérapant, facile à plier et avec une capacité de charge jusqu'à 15 kg.



RTT21N

Mini support pliant

28 x 20,5 x 23,5 cm - bois naturel



RTT21BK

Mini support pliant

28 x 20,5 x 23,5 cm - noir



RTT21MG

Mini support pliant

28 x 20,5 x 23,5 cm - acajou



Rejoignez-nous



@DbmarkTweet



@dbmarkhosteleria



@dbmark_inst

Tous les prix sont indiqués en P.V.P. unitaire.

Socles cascade



RACA300

Socles cascade

Set de 3 socles acacia

- Petit : 44 x 18 x 11,5 cm
- Moyen : 48,5 x 18 x 15,5 cm
- Grand : 56 x 18 x 18 cm



RBAM300

Socles cascade

Set de 3 socles bambou

- Petit : 44 x 18 x 11,5 cm
- Moyen : 48,5 x 18 x 15,5 cm
- Grand : 56 x 18 x 18 cm



RBK300

Socles cascade

Set de 3 socles bois noir

- Petit : 44 x 18 x 11,5 cm
- Moyen : 48,5 x 18 x 15,5 cm
- Grand : 56 x 18 x 18 cm



Socles réversibles en acier inoxydable

Ajoutez hauteur et intérêt à votre présentation de buffet avec les socles en acier inoxydables. Disponibles dans une variété de tailles pour s'adapter à nos gammes d'articles y compris les caisses en bois, les planches en mélamine, etc. Chaque socle dispose de coussinets antidérapants sur tous les côtés pour empêcher le plateau ou la planche de glisser.



21000

Socles pliants en acier inoxydable

52,5 x 32,5 x 10 cm
S'adapte à MG1 et CRATE11



INOX.



21001

Socles pliants en acier inoxydable

52,5 x 32,5 x 18,5 cm
S'adapte à MG1 et CRATE11



INOX.



21002

Socles pliants en acier inoxydable

32 x 26,5 x 10 cm
S'adapte à MG2 et CRATE12



INOX.



21003

Socles pliants en acier inoxydable

32 x 26,5 x 18,5 cm
S'adapte à MG2 et CRATE12



INOX.



21004

Socles pliants en acier inoxydable

S'adapte à MG3 et CRATE13



INOX.



21005

Socles pliants en acier inoxydable

32,5 x 17,5 x 18,5 cm
S'adapte à MG3 et CRATE13



INOX.



21006

Socles pliants en acier inoxydable

52 x 16 x 10 cm
S'adapte à MGL2



INOX.



21007

Socles pliants en acier inoxydable

52 x 16 x 18,5 cm
S'adapte à MGL2



INOX.

Tous les articles en **gras** sont des produits de stock habituel. Consulter les couleurs disponibles.

Socles en bois pliants

Socles pliants en bois de noyer. Rectangulaire et base métallique. Pieds pliants pour un plus grand confort de montage et démontage



RISER-3-W

Socle pliant en bois de noyer
35 cm x 19 cm, 8 cm haut.



RISER-6-W

Socle pliant en bois de noyer
40 cm x 21 cm, 15 cm haut.



RISER-9-W

Socle pliant en bois de noyer
50 cm x 25 cm, 23 cm haut.



Socles pliants en bois de bouleau. Offrent un aspect aussi naturel que moderne.



BBR18126

Socle pliant en bois de bouleau
47 x 32 x 16,5 cm



BBR181212

Socle pliant en bois de bouleau
47 x 32 x 30 cm



Socles pliants en bois naturel ou peints en noir. Coussinets antidérapants en silicone pour maintenir la stabilité des étagères d'exposition.



RMG1ACA

Cadre socle de bois d'acacia

Pour MG2 et MG3
38 x 20,5 x 29 cm



RMG1BK

Cadre socle de bois d'acacia
noir

Pour MG2 et MG3
38 x 20,5 x 29 cm



RMG2ACA

Cadre socle de bois d'acacia

Pour MG1 et MGL2
58,5 x 20,5 x 29cm



RMG2BK

Cadre socle de bois d'acacia
noir

Pour MG1 et MGL2
58,4 x 20,3 x 29,2 cm



*Étagères non incluses

Tous les prix sont indiqués en P.V.P. unitaire.

■ Présentoirs pour cônes



10030*

Présentoir pour 6 cônes

19,5 cm Ø x 25 cm



*Cônes non fournis



10031*

Présentoir pour 12 cônes

25,5 cm Ø x 35 cm



■ Présentoirs pour cônes et verrines

Présentez vos apéritifs, Couvertres ou desserts d'une manière unique en offrant des portions individuelles avec style et élégance.



DCH01*

Présentoir pour cônes

Pour 1 cône
5,5 x 6,5 x 10 cm
métal noir



● BK

*Cônes non fournis



DCH27*

Présentoir pour cônes

Pour 27 cônes
18,5 x 18,5 x 42 cm
métal chromé



● CH



DCH27BK*

Présentoir pour cônes

Pour 27 cônes
18,5 x 18,5 x 42 cm
métal noir



● BK



MTS-1122-BK*

Présentoir pour verrine

Pour 8 verrines SW-1435-CL
54 x 6,6 x 26 cm



● BK

*Verrines non fournies



MTS-1122-CH*

Présentoir pour verrine

Pour 8 verrines SW-1435-CL
54 x 6,6 x 26 cm



● CH



MTS-1496-BK*

Présentoir pour verrine

Pour 8 verrines SW-1435-CL
24,1 x 21,6 x 36,2 cm



● BK



Tous les articles en **gras** sont des produits de stock habituel. Consulter les couleurs disponibles.

■ Miniatures en fonte

Collection de jolies miniatures fabriquées en fonte. Surface antiadhérente et durabilité exceptionnelle. Nettoyage facile. Pour sauter, cuire, frire, rôtir ou même présenter vos préparations.

**CW30102**

Mini faitout rond
12,5 cm Ø x 4 cm /
16,5 cm Ø avec poignée
240 ml

**CW30104**

Mini faitout rond
13,5 cm Ø x 4,5 cm /
18 cm Ø avec poignée
355 ml

**CW30142**

Mini faitout rond
15,8 cm Ø x 4 cm
20,5 cm Ø avec poignée
530 ml

**CW30140**

Mini faitout rond
18,4 cm Ø x 5 cm
23 cm Ø avec poignée
830 ml

**CW30150**

Mini faitout carré
12,5 cm x 4 cm
17,5 cm avec poignée
355 ml

**CW30100**

Mini faitout ovale
21,5 x 15,5 x 6,5 cm
27 cm avec poignée
710 ml



Disponible en
cash&carry

**CW30122**

Mini poêle
10 cm Ø x 3,5 cm
avec une poignée de 9,5 cm
90 ml

**CW30124**

Mini poêle
14,5 cm Ø x 3 cm
avec une poignée de 12 cm
240 ml

**CW30108**

Mini poêle
14 cm Ø x 4 cm
avec une poignée de 9 cm
355 ml



Tous les prix sont indiqués en P.V.P. unitaire.

■ Miniatures en fonte (suite)



CW30110

Mini faitout rond
10 cm Ø x 8,5 cm
13 cm Ø avec poignée
240 ml avec couvercle



CW30148

Mini faitout rond
13 cm Ø x 9,5 cm
18 cm Ø avec poignée
530 ml avec couvercle



CW30146

Mini faitout rond
14 cm de Ø
x 10,5/18 cm Ø avec poignée
825 ml avec couvercle



CW30112

Mini faitout ovale
12,5 cm Ø x 9,5 x 8 cm / 15,5
cm Ø avec poignée
240 ml avec couvercle



CW30151

Marmite
15 x 12,5 x 7,5 cm - 475 ml



UCW01

Sous-plat
En acacia - pour CW30108
19 x 15 x 1,5 cm - jusqu'à
260 °C



CW30127

Sous-plat
En acacia - pour CW30126
32 x 24 x 1,5 cm



UCW10

Sous-plat
En acacia avec un revêtement
en silicone démontable
40 x 23 x 1,5 cm



Tous les articles en **gras** sont des produits de stock habituel. Consulter les couleurs disponibles.



■ Mini Vaisselle en acier inoxydable

Idéale pour servir et transporter du four à votre table. Disponible en différentes tailles, ces pièces ajoutent une sensation chaleureuse et décontractée à vos présentations. Faciles à nettoyer. Aptes pour l'induction.



10289
Mini poêle à paella
12 cm Ø
135 ml
12
INOX.



10290
Mini poêle à paella
15 cm Ø
190 ml
12
INOX.



10291
Mini faitout
12,5 cm Ø
355 ml
12
INOX.



10292
Mini faitout
15 cm Ø
473 ml
12
INOX.



10303
Mini cacerole empilable
12,7 cm Ø x 5,1cm
12
INOX.



10304
Couvercle pour casserole
12,7 cm Ø
12
INOX.



Tous les prix sont indiqués en P.V.P. unitaire.

Louches

4701

Louche en acier inoxydable
30,5 cm - 30 ml

 12

 INOX.

4702

Louche en acier inoxydable
32 cm - 60 ml

 12

 INOX.

4703

Louche en acier inoxydable
33 cm - 90 ml

 12

 INOX.

4704

Louche en acier inoxydable
35,5 cm - 120 ml

 12

 INOX.

4706

Louche en acier inoxydable
37 cm - 180 ml

 12

 INOX.

4708

Louche en acier inoxydable
37,5 cm - 240 ml

 12

 INOX.

4712

Louche en acier inoxydable
40,5 cm - 355 ml

 12

 INOX.

**LD85**

Louche en polycarbonate
21,6 cm - 25 ml

 12



 135  148

 110  133

**LD105**

Louche en polycarbonate
26,8 cm - 30 ml

 12



 135  148

 110  133

**LD130**

Louche en polycarbonate
33 cm - 30 ml

 12

 135  148

 110  133



Pinces et cuillères en acier inoxydable recouvert de silicone

Pinces et cuillères qui résistent à la chaleur jusqu'à 204 °C.

39103

Spatule en acier inoxydable recouverte de silicone

Spatule - 20,5 cm

 6



39104

Spatule en acier inoxydable recouverte de silicone

Spatule - 24 cm

 6



39105

Spatule en acier inoxydable recouverte de silicone

Spatule - 27,5 cm

 6



**39100**

Pince en acier inoxydable recouverte de silicone

Pince - 18 cm

 6



39101

Pince en acier inoxydable recouverte de silicone

Pince - 23 cm

 6



39102

Pince en acier inoxydable recouverte de silicone

Pince - 30,5 cm

 6





Tous les articles en **gras** sont des produits de stock habituel. Consulter les couleurs disponibles.

Pinces



74

Pince en acier inoxydable
24 cm - acier inox. 0,7 mm

12

INOX.



712

Pince en acier inoxydable
30,5 cm - acier inox. 0,7 mm

12

INOX.



716

Pince en acier inoxydable
40,5 cm - acier inox. 0,7 mm

12

INOX.



2774

Pince en acier inoxydable
24 cm - acier inox. 1,2 mm

12

INOX.



2712

Pince en acier inoxydable
30,5 cm - acier inox. 1,2 mm

12

INOX.



2716

Pince en acier inoxydable
40,5 cm - acier inox. 1,2 mm

12

INOX.



2009

Pince ergonomique
en acier inoxydable

23 cm - acier inox.
0,8 mm

12

INOX.

2012

Pince ergonomique
en acier inoxydable

30,5 cm - acier inox.
0,8 mm

12

INOX.

2016

Pince ergonomique
en acier inoxydable

35,5 cm - acier inox.
0,8 mm

12

INOX.

4007BK

Pince en acier inoxydable
et pointe en silicone

18 cm - acier inox. 0,8 mm

12

INOX.

4009BK

Pince en acier inoxydable
et pointe en silicone

23 cm - acier inox. 0,8 mm

12

INOX.

4012BK

Pince en acier inoxydable
et pointe en silicone

30,5 cm - acier inox. 0,8 mm

12

INOX.

4016BK

Pince en acier inoxydable
et pointe en silicone

41,5 cm - acier inox. 0,8 mm

12

INOX.



Tous les prix sont indiqués en P.V.P. unitaire.

Cuillères

SPO13

Cuillère haute température
Solide - 33 cm



● 110 ● 150

SPA14

Cuillère haute température
Solide - 35,5 cm



● 110 ● 150

SPO13

Cuillère haute température
Perforée - 33 cm



● 110 ● 150

SPASL14

Cuillère haute température
Perforée - 35,5 cm



● 110 ● 150



GET-22-

Cuillère en mélamine
Solide - 36,8 cm
89 ml



● BK



GET-25-

Cuillère en mélamine
Pour pâte
36,8 cm



○ W



Pot en plastique

Complétez la présentation de votre buffet avec des accessoires pour servir en polycarbonate, mélamine et plastiques résistants aux hautes températures et nos pots en plastiques. Idéals pour utilisation en buffet ou bars à salades.



CP12

Pot
12,9 cm Ø x 13,2 cm
haut. - 1,1 L



● 110 ● 133 ● 195



CP15

Pot
16,8 cm Ø x 11 cm
haut. - 1,4 L



● 110 ● 133 ● 195



CP27

Pot
16,8 cm Ø x 17,2 cm
haut. - 2,4 L



● 110 ● 133 ● 195



CPL12

Couvercle
Pour CP12



○ 148



CPL27

Couvercle
Pour CP15 et CP27



○ 148



CCP12

Pot
13,3 cm Ø x 13,7 cm
haut. - 1,1 L



○ 152



CCP15

Pot
17,2 cm Ø x 11,1 cm
haut. - 1,4 L



○ 152



CCP27

Pot
17,2 cm Ø x 17,5 cm
haut. - 2,4 L



○ 152



CCPL12

Couvercle
Pour CCP12



○ 148



CCPL27

Couvercle
Pour CCP15 et CCP27



○ 148

Tous les articles en **gras** sont des produits de stock habituel. Consulter les couleurs disponibles.

Corbeilles imitation osier, aptes au nettoyage en lave-vaisselle



Présentez pains et fruits avec ces corbeilles au design modernes. Elles ont l'image traditionnelle des corbeilles en osier mais sont fabriquées en plastique résistant et hygiénique. Les références WB sont aptes au lavage au lave-vaisselle.



WB-1506-
Corbeille rectangulaire
24,1 x 19,7 x 8,9 cm

12



WB-1507-
Corbeille rectangulaire
25,4 x 12,1 x 7,6 cm

12



WB-1508-
Corbeille rectangulaire
29,2 x 21,6 x 7 cm

12



WB-1509-
Corbeille rectangulaire
45,7 x 31,1 x 6,4 cm

12



WB-1513-TT
Corbeille rectangulaire
bords hauts
44,5 x 29,2 x 9,5 cm

6



WB-1518-TT
Corbeille rectangulaire
bords hauts
38,1 x 27,9 x 12,7 cm

6



WB-1524-
Corbeille rectangulaire avec anses
45,7 x 31,1 x 6,4 cm

12



WB-1520-TT
Corbeille rectangulaire avec anses
40,6 x 22,9 x 17,2 cm

6



WB-1519-TT
Corbeille rectangulaire avec anses
58,4 x 27,9 x 17,2 cm

6

Tous les prix sont indiqués en P.V.P. unitaire.



WB-1515-TT
Corbeille rectangulaire avec anses
47 x 34,3 x 17,2 cm
6



WB-1516-TT
Corbeille rectangulaire avec anses
55,9 x 39,4 x 15,2 cm
6



WB-1517-TT
Corbeille rectangulaire avec anses
58,4 x 43,2 x 17,8 cm
6



WB-1514-TT
Corbeille rectangulaire inclinée
59,7 x 44,5 x 6,4 cm devant /
12,1 cm fond
6



WB-1510-
Corbeille rectangulaire inclinée
23,5 x 33 x 10,2 cm devant /
17,8 cm fond
6

● BK ● HET ● N



ST-1511-BK
Présentoir pour deux Corbeilles
Présentoir pour deux Corbeilles WB-1510
6



WB-1521-TT
Corbeille haute ronde
30,5 cm Ø x 17,8 cm
6



WB-1522-TT
Corbeille haute ronde
35,6 cm Ø x 33 cm
6



WB-1523-TT
Corbeille haute ronde
43,2 cm Ø x 36,8 cm
6

Tous les articles en **gras** sont des produits de stock habituel. Consulter les couleurs disponibles.

■ Corbeilles imitation osier, aptes au nettoyage en lave-vaisselle (suite)



WB-1552-

Corbeille rectangulaire

53,3 x 32,4 cm

12

Cloche non fournie

● BK ● HET



WB-1553-

Corbeille rectangulaire

41,3 x 27,9 cm

12

Cloche non fournie

● BK ● HET



CO-3065-CL

Cloche pour WB-1552
transparente (CL)

54 x 33 cm

2

Corbeille non fournie

● CL



CO-3426-CL

Cloche pour WB-1553
transparente (CL)

42,5 x 29,2 cm

2

Corbeille non fournie

● CL



WB-1551-

Corbeille ronde
39,4 cm Ø

12

Cloche non fournie

● BK ● HET



CO-2098-CL

Cloche ronde pour
WB-1551, transparente (CL)

2

Cloche non fournie

● CL



■ Corbeilles imitation osier aptes au nettoyage au lave-vaisselle

Enfin une corbeille tissée à la main et lavable au lave-vaisselle ! Conçues en polypropylène, elles offrent une solide fabrication pour maintenir leurs formes dans la durée.



M2475

Corbeille ronde

20,9 x 20,9 x 8,2 cm

12

● BK



M2474

Corbeille ovale

23,4 x 15,8 x 8,2 cm

12

● BK



M2485

Corbeille rectangulaire

29,8 x 22,2 x 7,6 cm

6

● BK



M2489

Corbeille rectangulaire

42,5 x 29,8 x 8,8 cm

6

● BK

M2493

Corbeille rectangulaire

48,2 x 35,5 x 10,1 cm

6

● BK

Tous les prix sont indiqués en P.V.P. unitaire.

■ Corbeilles imitation osier

Corbeilles tissée main avec cordon en polypropylène, vinyle avec bord métallique doré et bois naturel de saule. Se nettoient facilement avec un chiffon humide.



1177W

Corbeille ronde en polypropylène, couleur naturelle

18,4 x 18,4 x 6,3 cm

12

● N



1175W

Corbeille ronde en polypropylène, couleur naturelle

21,5 x 21,5 x 5,7 cm

12

● N



1169W

Corbeille ronde en polypropylène, couleur naturelle

25,4 x 25,4 x 5 cm

12

● N



1475

Corbeille ronde en polypropylène, marron

21,5 x 21,5 x 5,7 cm

12

● BR



1135W

Corbeille ronde en polypropylène, couleur naturelle. Tressage aéré

21,5 x 21,5 x 8,2 cm

12

● N



1172W

Corbeille rectangulaire en polypropylène, couleur naturelle

22,2 x 15,8 x 6,9 cm

12

● N



1188W

Corbeille rectangulaire en polypropylène, couleur naturelle

35,5 x 25,4 x 7,6 cm

12

● N



1189W

Corbeille rectangulaire en polypropylène, couleur naturelle

41,9 x 29,2 x 7,6 cm

12

● N



1192W

Corbeille rectangulaire en polypropylène, couleur naturelle

45,7 x 31,7 x 8,2 cm

12

● N



2472

Corbeille rectangulaire en polypropylène couleur noir

22,8 x 15,8 x 6,3 cm

12

● BK



1472

Corbeille rectangulaire en polypropylène couleur marron

23 x 15 x 6,5 cm

12

● BR



2488

Corbeille rectangulaire en polypropylène couleur noir

35,5 x 25,4 x 7,6 cm

12

● BK



2489

Corbeille rectangulaire en polypropylène couleur noir

25,4 x 25,4 x 5 cm

12

● BK

Tous les articles en **gras** sont des produits de stock habituel. Consulter les couleurs disponibles.

■ Corbeilles imitation osier (suite)



1117W

Corbeille allongée
en polypropylène,
couleur naturelle

23 x 9 x 5 cm

12

● N



1113W

Corbeille allongée
en polypropylène,
couleur naturelle

33,6 x 13,3 x 8,2 cm

12

● N



1118W

Corbeille allongée
en polypropylène,
couleur naturelle

38,1 x 15,2 x 7,6 cm

12

● N



1689

Corbeille rectangulaire
de rotin de saule

35,5 x 25,4 x 7,6 cm

6

● N



1692

Corbeille rectangulaire
de rotin de saule

45,5 x 33 x 7,5 cm

6

● N



161716

Corbeille rectangulaire
de rotin de saule, inclinée

48,2 x 39,3 cm
hauteurs 5 et 19 cm

4

● N



Accédez aux principaux outils de Cambro

L'application Cambro vous donne instantanément accès aux principaux outils et aux ressources de Cambro.

De la personnalisation d'un plateau jusqu'à la découverte de la gamme complète de conteneurs de Cambro.

<https://www.cambro.com/app/>



Tous les prix sont indiqués en P.V.P. unitaire.



■ Corbeilles multifonctions

Servez ce qui vous passe par la tête, n'importe où avec ces corbeilles multifonctions. Choisissez parmi une variété de couleurs et de tailles pour créer le meilleur look adapté à votre environnement. Aptes au lavage au lave-vaisselle et à l'usage au micro-ondes.



1071

Corbeille multifonction ovale

20 x 13,5 x 5 cm - PE

36

● BK ● R ● FG



1073

Corbeille multifonction ovale

23,5 x 15 x 4 cm - PP

36

● BK ● R ● FG



1074

Corbeille multifonction ovale

23,5 x 15,5 x 5 cm - PP

36

● BK ● BR ● FG
● Y ● GM ● R
● G



1076

Corbeille multifonction ovale

27 x 18,5 x 3,5 cm - PP

36

● BK ● R ● FG ● BR



1084

Corbeille multifonction ovale

30 x 23 x 5 cm - PP

36

● BK ● R



1086

Corbeille multifonction ovale

32,5 x 24 x 4 cm - PP

36

● BK ● R



1075

Corbeille multifonction ronde

20,5 x 20,5 x 5 cm - PP

36

● BK ● R ● FG



1077

Corbeille multifonction rectangulaire

27 x 18,5 x 3,5 cm - PP

36

● BK ● R ● BR



13759

Plat rond noir

23 cm Ø x 3 cm - PP

12

● BK

2,95 €

● R



137510

Plat rond rouge

26,5 cm Ø x 5,5 cm - PP

12

● R

3,69 €

● BK

Tous les articles en **gras** sont des produits de stock habituel. Consulter les couleurs disponibles.

■ Cestas multifonction (suite)



15759

Plat rond avec socle
23 cm Ø x 4,5 cm - PP

 12

● BK



157510

Plat rond avec socle
26,5 cm Ø x 5,5 cm - PP

 12

● BK



157512

Plat rond avec socle
30 cm Ø x 6 cm - PP

 12

● BK

■ Corbeilles Méditerranéennes Collection

Collection élégantes de corbeilles en métal noir. Parfaites pour exposer pain et fruit sur votre buffet.



BK21709

Corbeille allongée
23 x 10,5 cm x 5,5 cm

 6

● BK



BK256

Petit panier pour sachets de sucre
8 x 6,5 x 5 cm

 6

● BK



BKT2A

Corbeille à étages
2 étages
22,9 / 26,7 cm Ø x 31 cm haut.

 1

● BK



BKT2

Corbeille à étages
2 étages
24,5 / 30,5 cm Ø x 61,5 cm haut.

 1

● BK



BKT3

Corbeille à étages
3 étages
25,4 / 30,5 / 35,6 cm Ø x 85 cm haut.

 1

● BK

Tous les prix sont indiqués en P.V.P. unitaire.

■ Corbeilles Artisan Collection

Corbeilles de grandes tailles, ideales pour montrer une grande variété de produits. Aspect noir métallisé.



BK17508

Corbeille ronde
20,3 cm Ø x 5,7 cm prof.



● BK



BK17510

Corbeille ronde
25,4 cm Ø x 7,6 cm prof.



● BK



BK17409

Corbeille ovale
23,4 x 15,8 cm x 5,7 cm prof.



● BK



BK17410

Corbeille ovale
25,4 x 17,1 x 8,2 cm prof.



● BK



BK17412

Corbeille ovale
30 x 23 cm x 7,5 cm prof.



● BK



BK17209

Corbeille rectangulaire
23,4 x 15,8 cm x 6,3 cm prof.



● BK



BK11709

Corbeille allongée
22,8 x 10,1 x 5 cm prof.



● BK



BK155

Panier long
5 x 5 x 6,3 cm



● BK

■ Panier porte couverts

Support en metal recouverts de poudre noire avec 3 flacons en verre qui peuvent se laver au lave-vaisselle. Paniers lavable exclusivement à la main. Une façon originale de présenter les couverts dans un buffet.



MJRM3

Panier porte couverts
21,5 x 19,5 x 21,5 cm



● BK



MJRB3

Panier porte couverts
22 x 21 x 21,5 cm



● BK



MJGLASS

Bocal de remplacement
10 x 10 x 12,5 cm - 650 ml



●



Tous les articles en **gras** sont des produits de stock habituel. Consulter les couleurs disponibles.

■ Corbeilles en acier inoxydable

Corbeilles en acier inoxydable argentées ou recouvertes en PVC noir, parfaites pour servir de menus avec un style industriel très original.



4-835809

Corbeille rectangulaire grillagée
22,9 x 17,8 cm



● INOX.



4-835814

Corbeille rectangulaire grillagée
35,6 x 17,8 cm



● INOX.



4-83599

Corbeille carrée grillagée
23 x 23 x 2,5 cm



● INOX.



4-35814

Corbeille grillagée
Recouverte en PVC noir
35,6 x 17,8 cm



● BK



4-35999

Corbeille grillagée
Recouverte en PVC noir
22,9 x 22,9 cm



● BK



4-35809

Corbeille grillagée
Recouverte en PVC noir
22,9 x 17,8 cm



● BK

■ Corbeilles Bouclé Collection

Corbeilles à la mode pour servir pain, hamburgers, sandwiches, etc. d'une manière différente. Aspect noir métallisé.



BK37508

Corbeille ronde
19 cm Ø x 5 cm prof.



● BK



BK37409

Corbeille ovale
21,5 x 14 cm x 4 cm prof.



● BK



BK37410

Corbeille ovale
25,5 x 17 cm x 5 cm prof.



● BK



BK37109

Corbeille rectangulaire
20,5 x 11,5 cm x 4 cm prof.



● BK

Tous les prix sont indiqués en P.V.P. unitaire.



■ Corbeilles de présentation en acier inoxydable

Servez vos hamburgers, sandwichs et autres accompagnements dans ces corbeilles en acier inoxydable. Elles peuvent s'utiliser avec des revêtements en papier ou en tissu. Empilables pour faciliter le rangement et le transport.



123472
Corbeille ovale grande en acier inoxydable
30,5 x 21,6 x 4,5 cm
1
INOX.



123471
Corbeille ovale petite en acier inoxydable
24,1 x 15,2 x 5 cm
1
INOX.



123473
Corbeille petite en acier inoxydable
27,3 x 17,8 x 3,8 cm
1
INOX.

123475
Corbeille rectangulaire en acier inoxydable
26,7 x 20,3 x 5 cm
1
INOX.



123476
Corbeille rectangulaire en acier inoxydable
30,5 x 22,2 x 4,5 cm
1
INOX.



Tous les articles en **gras** sont des produits de stock habituel. Consulter les couleurs disponibles.



1.M **DISTRIBUTEURS DE FRUITS**

■ Distributeurs de fruits

Nous vous présentons nos originaux distributeurs de fruits qui donneront un air moderne et élégant à votre buffet. Fabriqués en métal chromé couleur argent.



FC1649
Distributeur de fruits
Recourbé - 37 x 16 x 45,5 cm
 1





FSL1508
Distributeur de fruits
Incliné - 39,5 x 19 x 42 cm
 1



FSP1507
Distributeur de fruits
En spirale
23 x 23 x 47 cm
 1

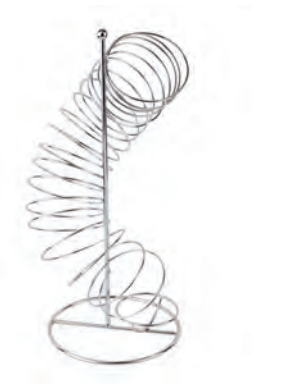

12SR
Distributeur de fruits
Carré avec crochet
30,5 x 31 x 46,5 cm
 1



Tous les prix sont indiqués en P.V.P. unitaire.



1.N DISTRIBUTEUR DE BOISSONS

■ Distributeurs de boissons

Nous disposons d'une grande variété de distributeurs de boissons de tout types. Leur utilisation s'adapte aussi bien en intérieur qu'en extérieur pour buffets ou célébrations. Disponibles en différents styles qui s'adaptent à tous les décors.



N175
 Distributeur en acier inoxydable et tritan
 28,5 x 28,5 x 59,5 cm - 11,5 L
 Infuseur inclus
 1



75
 Distributeur en acier inoxydable et tritan
 27,5 x 27,5 x 49,5 cm - 9,5 L
 Infuseur inclus
 1



Disponibles en cash&carry



85
 Distributeur en acier inoxydable et tritan
 31 x 33,5 x 62 cm - 19 L
 Infuseur inclus
 1



BAD1500
 Distributeur en acier inoxydable et tritan
 Plástico - 24 x 24 x 34,5 cm - 5,5 L
 Infuseur inclus
 1



Tous les articles en **gras** sont des produits de stock habituel. Consulter les couleurs disponibles.

■ Distributeur de liquides (suite)



BDG1000

Distributeur en verre
23 x 27,5 x 37 cm - 9,8 L
Infuseur et pancarte ardoise inclus



BDG2000

Distributeur en verre
21 x 26,5 x 35,5 cm - 8,7 L
Pancarte ardoise inclus



BDG3000

Distributeur en verre
19,5 x 26 x 32 cm - 7,6 L
Infuseur et pancarte ardoise inclus



123494

Distributeur en verre, robinet acier inox.
23 x 27,5 x 37 cm - 9,8 L
Infuseur et pancarte ardoise inclus



123495

Distributeur en verre, robinet acier inox.
21 x 26,5 x 35,5 cm - 8,7 L
Pancarte ardoise inclus



123496

Distributeur en verre, robinet acier inox.
19,5 x 26 x 32 cm - 7,6 L
Infuseur et pancarte ardoise inclus



■ *Nouveauté* ■



10699

Distributeur de boisson en verre
Robinet plastique chromé,
21,5 x 26 x 36,5 cm



Tous les prix sont indiqués en P.V.P. unitaire.



■ Collection Industrial



10360

Distributeur de boissons en verre avec couvercle fileté en acier inoxydable
5,5 litres, infuseur, pancarte en ardoise et accessoires à glaçons inclus



10090

Distributeur de boissons en verre avec couvercle fileté métal noir
7,5 litres, infuseur, pancarte en ardoise et accessoires à glaçons inclus



10262

Socle pour distributeur de boissons
Métal recouvert de poudre noire, avec ouverture pour robinet de 21,5 cm



Tous les articles en **gras** sont des produits de stock habituel. Consulter les couleurs disponibles.

■ Distributeur de liquides (suite)

Nouveauté

*Zéro contact !
Sécurité et hygiène
maximale*



BDCHBD

Pancarte ardoise.
S'adapte à tous
les distributeurs
10 x 7,5 cm



10758

Chainette galvanisée.
S'adapte à tous
les distributeurs
10 x 7,5 cm



10626

Robinet universel noir.
S'adapte à tous les
distributeurs



123497

Robinet en acier inoxydable.
S'adapte à tous
les distributeurs



BDGINFCORE

Accessoire à glaçons et
infuseur. S'adapte à tous
les distributeurs BDG1000,
BDG3000, 123494 ET 123496



BDG1000T

Bouchon de rechange
pour distributeur BDG1000

15 x 15 x 5 cm



BDG2000T

Couvercle de rechange
pour distributeur BDG2000
et 123495

12 x 12 x 3 cm



BDG3000T

Couvercle de rechange
pour distributeur BDG3000
et 123496

14,5 x 14,5 x 2 cm



BDGR1

Présentoir pour distributeur
BDG1000, BDG2000 et BDG3000

34 x 25,5 x 33 cm

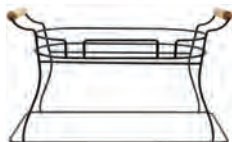

BDGR2

Présentoir double
pour distributeur BDG1000,
BDG2000 et BDG3000

56,5 x 25,5 x 33 cm



BDGTUB

Présentoir galvanisé
pour DG1000, BDG2000
et BDG3000

24 x 24 x 19,5 cm



*Réversible
pour servir comme
seau à boisson!*

Tous les prix sont indiqués en P.V.P. unitaire.



1.0 CHAFING DISHES

Chafing dishes

Parfaits pour maintenir la température des aliments de vos buffets. En acier inoxydable poli, pour créer des présentations innovantes, parfaites pour vos réunions, réceptions et autres événements. Des produits de la plus haute qualité pour que vos événements soient mémorables.



CW40161
Chafing dish à induction - taille complète
Avec fenêtre - 58 x 44 x 21 cm - 8 L



INOX.



CW40163
Chafing dish à induction - taille 2/3
Avec fenêtre - 40,5 x 42,5 x 21cm - 5,7 L



INOX.



CW40165
Chafing dish rond à induction
Avec fenêtre - 44 x 49 x 19 cm - 4,5 L



INOX.



CW40167
Chafing dish à combustible - taille complète
Avec couvercle giratoire
65 x 45 x 44 cm - 8 L



INOX.



CW40175
Chafing dish à combustible - taille complète
Avec fenêtre
58 x 45,5 x 33 cm - 8 L



INOX.



Tous les articles en **gras** sont des produits de stock habituel. Consulter les couleurs disponibles.

■ Chafing dishes (suite)



CW40176

Chafing dish à combustible - taille 2/3
Avec fenêtre - 40,5 x 44 x 32,5 cm - 5,7 L



● INOX.



CW40177

Chafing dish rond à combustible
Avec fenêtre - 44 x 49,5 x 31 cm - 4,5 L



● INOX.



3177GCS

Combustible liquide
Réservoir combustible 4/2/5
- Chaleur haute : 2 heures
- Chaleur moyenne : 4 heures
- Chaleur basse : 5 heures



24

3177GCSP

Combustible liquide
Palette complète de réservoirs 4/2/5
- Chaleur haute : 2 heures
- Chaleur moyenne : 4 heures
- Chaleur basse : 5 heures



1.440

Sûr

Le combustible utilisé, le dietilen glycol, est de la même catégorie non inflammable que l'huile végétale

Flamme variable

Vous pouvez choisir entre une flamme standard, haute ou basse en fonction de vos besoins

Consistant

À la différence du gel, la flamme se maintient à la même hauteur au-dessus du réservoir

Économique

Moins cher que les gels-combustibles

Réutilisable

À refermer entre utilisations pour être réutilisé plusieurs fois



Inodore

Combustion sans odeur. Vous sentirez la nourriture et pas le combustible

Tous les prix sont indiqués en P.V.P. unitaire.



Grâce à l'évolution dans la fabrication et la conception de vaisselle et de verrerie, il est possible d'avoir des pièces de présentation élégantes en utilisant les matériaux les plus résistants et sûrs. Choisissez le matériel qui correspond le mieux à vos besoins en fonction des critères suivants :

Vaisselle en polycarbonate : Offre une résistance et une garantie maximales. Idéal pour un environnement où la sécurité est primordiale, comme dans les crèches et les écoles maternelles, les EHPAD les prisons, les hôpitaux, etc.

Vaisselle en mélamine : Aussi élégante et voyante que la porcelaine, mais beaucoup plus résistante et très légère. Elle convient aux lieux nécessitant une vaisselle robuste (écoles, résidences, restaurants et commerces très fréquentés : self-service, cantines d'entreprise, zones de restauration de centres commerciaux, etc.)

Verrerie en polycarbonate : Sécurité maximale, garantie et résistance. Incontournable dans les écoles, les résidences et les zones de piscine d'hôtels et de restaurants.

Verrerie acrylique (SAN) : Sécurité maximale et résistance élevée. C'est une alternative économe au polycarbonate, tout en conservant ses qualités de sécurité.

Collection Diamond White

La vaisselle en mélamine de G.E.T. est considérée comme la plus élégante et de meilleure qualité de l'industrie. G.E.T. offre un choix varié de pièces et de décors différents tout aussi attrayants que la vaisselle en porcelaine. Demandez un échantillon et vous verrez que sa légèreté est l'unique aspect qui différencie la mélamine G.E.T. de la porcelaine.



WP-5-DW

Assiette ronde bord large

14 cm Ø



○ w

WP-6-DW

Assiette ronde bord large

16,5 cm Ø



○ w

WP-7-DW

Assiette ronde bord large

19,1 cm Ø



○ w

WP-9-DW

Assiette ronde bord large

22,9 cm Ø



○ w

WP-10-DW

Assiette ronde bord large

26,7 cm Ø



○ w

WP-12-DW

Assiette ronde bord large

30,5 cm Ø



○ w



B-139-DW

Assiette creuse ronde
23,5 x 3,2 cm prof.



○ w



B-1611-DW

Assiette creuse ronde
28,6 x 4,4 cm prof.



○ w



B-2412-DW

Assiette creuse ronde
31,8 x 5,1 cm prof.



○ w



OP-950-DW

Assiette ovale
24,8 x 18,4 cm



○ w



OP-120-DW

Assiette ovale
30,5 x 22,9 cm



○ w



OP-135-DW

Assiette ovale
34,3 x 26 cm



○ w



OP-145-DW

Assiette ovale
37,5 x 26,7 cm



○ w

Tous les prix sont indiqués en P.V.P. unitaire.



B-454-DW

Bol bas
12,1 x 3,2 cm prof.
148 ml

☑ 48

○ w



B-86-DW

Bol bas
15,2 x 3,8 cm prof.
237 ml

☑ 48

○ w



B-24-DW

Bol bas
19,1 x 7 cm prof.
1 L

☑ 12

○ w



B-127-DW

Bol bas
18,4 x 4,4 cm
458 ml

☑ 24

○ w



B-167-DW

Bol bas
19,1 x 4,4 cm prof.
532 ml

☑ 24

○ w



B-925-DW

Bol bas
22,9 x 4,4 cm prof.
1 L

☑ 12

○ w



B-45-DW

Bol profond
11,4 x 5,7 cm prof. - 311 ml

☑ 24

○ w



B-525-DW

Bol profond
13,3 x 6,3 cm prof. - 485 ml

☑ 24

○ w



B-105-DW

Bol profond
14 x 5,7 cm prof. - 296 ml

☑ 48

○ w



B-49-DW

Bol profond
22,9 x 6,3 cm prof. - 1,8 L

☑ 12

○ w



B-48-DW

Bol profond
24,8 x 7 cm prof. - 1,8 L

☑ 12

○ w



M-815-DW

Bol profond
27,3 x 13,3 cm prof. - 5,2 L

☑ 12

○ w



BC-70-DW

Bol profond
10,2 x 5,1 cm prof. - 231 ml

☑ 48

○ w



BC-170-DW

Bol profond
11,4 x 5,7 cm prof. - 290 ml

☑ 48

○ w

Tous les articles en **gras** sont des produits de stock habituel. Consulter les couleurs disponibles.

Collection Diamond White (suite) 



C-1004-W

Tasse
6,3 x 5,7 cm prof.
104 ml

 48

○ w



C-108-W

Tasse
8,3 x 7,6 cm prof.
207 ml

 24

○ w



C-107-W

Tasse
8,3 x 8,3 cm
257 ml

 24

○ w



TM-1208-W

Tasse
8,3 x 8,9 cm prof.
281 ml - SAN

 24

○ w



TM-1308-W

Tasse
8,3 x 9,5 cm prof.
296 ml - TRITAN

 24

○ w



BF-080-W

Tasse
10,2 x 5,7 cm prof.
347 ml

 24

○ w



S-12-W

Tasse
8,9 x 8,3 cm prof.
355 ml

 24

○ w



C-1001-W

Tasse
11,4 x 8,3 cm prof.
556 ml

 12

○ w



C-1002-W

Tasse
12,1 x 8,9 cm prof.
739 ml

 12

○ w



DC-101

Tasse
8,3 x 7,6 cm prof.
228 ml

 48

○ w



SU-4-DW

Sous tasse
11,4 cm - pour C-1004

 48

○ w



SU-3-DW

Sous tasse
14 cm - pour B-105, BC-70,
BC-170, B-454, C-107

 48

○ w



SU-2-DW

Sous tasse
14 cm - pour C-108, TM-1208,
TM-1308

 48

○ w



DC-200

Sous tasse
14,6 cm - pour DC-101

 48

○ w

Rejoignez-nous



@DbmarkTweet



@dbmarkhosteleria



@dbmark_inst

Tous les prix sont indiqués en P.V.P. unitaire.



Nouveauté

Collection Pulito

Conçue pour imiter la céramique, fabriquée en mélamine très durable, cette collection apporte de l'élégance à votre table. Sa couleur blanche neutre se marie à tous les décors.



10413
Salière et poivrier

Jeu de 2, finition texturisée



○ w



10414
Jarre

7,5 cm Ø x 9 cm



○ w



10415
Sucrier

10 x 8 x 5 cm



○ w



10416
Pot à sucre avec couvercle

7,5 cm Ø x 10,5 cm



○ w



RAM2RW
Ramequin finition cannelée

60 ml



○ w



RAM3RW
Ramequin finition cannelée

90 ml



○ w



RAM4RW
Ramequin finition cannelée

120 ml



○ w



123460
Assiette à pâtes

25,5 cm Ø x 5 cm



○ w



10515
Petite assiette

15 cm Ø



○ w



10496
Grande assiette

33 cm Ø



○ w

Tous les articles en **gras** sont des produits de stock habituel. Consulter les couleurs disponibles.



Collection Siciliano

La collection Siciliano offre des lignes modernes et des tailles pratique qui vous permettent de donner libre cours à votre créativité. Combinez-la avec la collection Diamond White pour une plus grande polyvalence.



CS-6100-W

Assiette plate

19,7 cm Ø

 12

○ w



207-5-W

Assiette plate

26,7 cm Ø

 12

○ w



CS-6102-W

Assiette plate

30,5 cm Ø

 12

○ w



CS-6108-W

Assiette plate

35,6 cm Ø

 12

○ w



CS-6107-W

Assiette creuse

26,7 cm x 3,8 cm prof.
946 ml

 12

○ w



CS-6116-W

Assiette carrée

15,2 x 15,2 cm

 24

○ w



CS-6119-W

Assiette carrée

24,1 x 24,1 cm

 12

○ w

Tous les prix sont indiqués en P.V.P. unitaire.

Collection Siciliano (suite) 



CS-6104-W

Assiette rectangulaire
24,8 x 14,7 cm



CS-6103-W

Assiette rectangulaire
28,6 x 17,8 cm



CS-6105-W

Assiette rectangulaire
33 x 19,8 cm



CS-6111-W

Assiette ovale
27,9 x 23,5 cm



CS-6112-W

Assiette ovale
33,7 x 24,1 cm



CS-6101-W

Bol
15,9 cm Ø x 5,7 cm prof.
692 ml



CS-6106-W

Bol
21,6 cm Ø x 5,7 cm prof.
1,3 L



Vous voulez être au courant?
Venez sur notre site Web
et vous serez tenus informés de nos nouveautés,
nouvelles, promotion, etc.

www.dbmark.com

Tous les articles en **gras** sont des produits de stock habituel. Consulter les couleurs disponibles.



Collection Pottery Market - émaillé

Cette collection apporte le style authentique de la poterie artisanale, sans ses problèmes de fissure ou de coût. C'est le style artisanal du moment. Disponible en deux couleurs : crème (CRM) et marron (BR).



P-100-
Saladier
25,4 cm Ø
946 ml

 12

● CRM ● BR



P-101-
Assiette plate ronde
26,7 cm Ø

 12

● CRM ● BR



P-129-
Assiette ovale
29 cm x 23,5 cm

 12

● CRM ● BR



P-75-
Assiette d'accompagnement petite
19,1 cm Ø

 12

● CRM ● BR



B-300-
Bol à soupe
15,9 cm Ø
414 ml

 12

● CRM ● BR



B-303-
Bol à salade
17,8 cm Ø
946 ml

 12

● CRM ● BR

Tous les prix sont indiqués en P.V.P. unitaire.

Collection Pottery Market - mat

Dans sa version mate, cette collection est disponible en quatre couleurs : marron (TP), gris (GR), bleu (GBL) y Manille (MA).



CS-100-

Assiette creuse ronde

26,7 cm Ø

 12

● TP ● GR ● GBL ● MA



CS-90-

Assiette creuse ronde petite

22,9 cm Ø

 12

● TP ● GR ● GBL ● MA



CS-70-

Assiette ronde petite à pain

17,8 cm Ø

 12

● TP ● GR ● GBL ● MA



B-420-

Assiette creuse profonde

1,2 L

25,4 cm Ø

4,4 cm prof.

 12

● TP ● GR ● GBL ● MA



B-180-

Bol à salade

473 ml

17,8 cm Ø

4,4 cm prof.

 12

● TP ● GR ● GBL ● MA



B-80-

Bol

237 ml

12,7 cm Ø

5,1 cm prof.

 24

● TP ● GR ● GBL ● MA



CS-1170-

Plat apéritif petit

30,5 cm x 19 cm

 12

● TP ● GR ● GBL ● MA



Tous les articles en **gras** sont des produits de stock habituel. Consulter les couleurs disponibles.

Collection Settlement Bistro



Profitez de plats simples et délicieux. Disponible en deux versions : blanc avec bord noir (W/BK) ou blanc avec bord bleu (W/CB).



B-30-

Bol petit

9,2 cm Ø x 3,2 cm prof.
89 ml



48

W/BK W/CB



B-50-

Bol à garniture

12,7 cm Ø x 3,2 cm
prof.
133 ml



48

W/BK W/CB



B-60-

Bol à garniture

14,6 x 13,3 x 3,2 cm
prof.
177 ml



48

W/BK W/CB



B-100-

Bol ovale

17,8 x 17,1 x 3,2 cm
prof.
296 ml



24

W/BK W/CB



B-140-

Bol grand

14,6 cm Ø x 5,7 cm prof.
414 ml



24

W/BK W/CB



B-110-

Assiette à salade

22,9 cm Ø
296 ml



12

W/BK W/CB



B-220-

Assiette à pâte

27,9 cm Ø x 3,2 cm prof.
710 ml



12

W/BK W/CB



OP-960-

Assiette ovale petite

22,9 cm x 15,9 cm



24

W/BK W/CB



OP-1291-

Assiette ovale grande

31,1 cm x 22,9 cm



12

W/BK W/CB



CS-800-

Assiette plate petite

20,3 cm Ø



48

W/BK W/CB



CS-900-

Assiette plate moyenne

22,9 cm Ø



24

W/BK W/CB



CS-1100-

Assiette plate grande

27,9 cm Ø



12

W/BK W/CB



CS-1280-

Plat rectangulaire

29,8 x 19,7 cm



12

W/BK W/CB

Tous les prix sont indiqués en P.V.P. unitaire.

Collection Coralline

Jolies pièces de vaisselle de différentes tailles et formes originales. Avec texture tissée entrelacée. Améliorez vos présentations avec cette collection d'apparence céramique mais avec une durabilité exceptionnelle.



CS-1180-CN-W

Assiette triangulaire
27,3 x 22,2 x 17,1 cm

 12

w



CS-1259-CN-W

Assiette triangulaire
31,8 x 25,4 x 22,9 cm

 12

w



CS-1270-CN-W

Plat rectangulaire
30,5 x 17,8 cm

 12

w



CS-1450-CN-W

Plat rectangulaire
35,6 x 12,7 cm

 12

w



CS-1811-CN-W

Plat rectangulaire
45,7 x 27,9 cm

 3

w



CS-1070-CN-W

Bol triangulaire
12,7 x 11,4 x 10,2 cm
4,4 cm prof.
296 ml

 12

w



CS-6352-CN-W

Bol triangulaire
15,9 x 13,3 x 12,7 cm
5,7 cm prof.
473 ml

 12

w



CS-1080-CN-W

Bol triangulaire
22,2 x 21 x 19,1 cm
8,2 cm prof.
1,9 L

 3

w



CS-1090-CN-W

Bol triangulaire
26,7 x 22,9 x 17,8 cm
10,2 cm prof.
2,8 L

 3

w



CS-1198-CN-W

Bol triangulaire
29,8 x 24,8 x 22,9 cm
10,8 cm prof. - 3,8 L

 3

w

Tous les articles en **gras** sont des produits de stock habituel. Consulter les couleurs disponibles.



Collection Mill

Collections de mélamine de haute qualité avec une surface vitrée pour une meilleure résistance aux taches. Avec des formes irrégulières et des couleurs rustiques, cette collection nous offre l'apparence de la céramique fait main, mais légère et robuste. Disponible en trois tons : Rustic Mill (RM), Urban Mill (UM) y French Mill (FM).



CS-7-

Assiette plate

17,8 cm Ø

 12



CS-9-

Assiette plate

22,9 cm Ø

 12



CS-10-

Assiette plate

27,7 cm Ø

 12



CS-117-

Plat

Rectangulaire - 30,5 x 19,1 cm

 12



B-8-

Bol / saladier

12,7 cm Ø x 5,1 cm haut. - 355 ml

 24



B-18-

Bol / saladier

17,8 cm Ø x 4,4 cm haut. - 591 ml

 12



B-42-

Bol / saladier

27,7 cm Ø x 4,4 cm haut. - 1,3 L

 12

Tous les prix sont indiqués en P.V.P. unitaire.



Collection Barnwood

Disponible en plusieurs tailles, ces pièces ajoutent une touche décontractée à vos présentatins. Nettoyage facile et apte au lavage au lave-vaisselle.



10020

Plat carré
14 x 14,5 cm
🍽️ 12



10021

Plat carré
25,5 x 25 cm
🍽️ 6



10022

Plat carré
30 x 29,5 cm
🍽️ 6



10023

Plat carré
38 x 37 cm
🍽️ 4



Tous les articles en **gras** sont des produits de stock habituel. Consulter les couleurs disponibles.



Collection Cosmo

Mélamine de qualité supérieure à surface vitrée pour une meilleure résistance aux taches. Avec des formes irrégulières et des couleurs rustiques, elle nous offre l'apparence de la céramique faite à la main, mais légère et robuste. Couleurs disponibles : bleu (CSB) et vert (CSG).



CS-7-

Assiette plate

17,8 cm Ø

 12

 CSB  CSG



CS-9-

Assiette plate

22,9 cm Ø

 12

 CSB  CSG



CS-10-

Assiette plate

27,7 cm Ø

 12

 CSB  CSG



CS-117-

Plat

rectangulaire - 30,5 x 19,1 cm

 12

 CSB  CSG



B-8-

Bol / saladier

12,7 cm Ø x 5,1 cm haut. - 237 ml

 24

 CSB  CSG



B-18-

Bol / saladier

17,8 cm Ø x 4,4 cm haut. - 592 ml

 12

 CSB  CSG



B-42-

Bol / saladier

27,7 cm Ø x 4,4 cm haut. - 1,3 L

 12

 CSB  CSG

Tous les prix sont indiqués en P.V.P. unitaire.



Nouveauté

Collection Enamelware

Cette vaisselle, émaillée en bleu, de très bonne qualité apporte de l'élégance à votre table. Excellente durabilité lorsque les conditions d'utilisation et d'entretien sont respectées.



10154
Tasse
7 cm Ø x 6,5 cm
190 ml



10155
Tasse
8,5 cm Ø x 9 cm
400 ml



10156
Tasse
9 cm Ø x 10 cm
550 ml



10157
Verre
10 cm Ø x 12,5 cm
500 ml



10161
Plateau rectangulaire
41 x 29 x 4 cm



10158
Plat rectangulaire
19,5 x 14,5 x 4,5 cm



10159
Plat rectangulaire
24 x 18 x 5 cm



10160
Plat rectangulaire
28 x 20,5 x 6 cm



10163
Petite assiette ronde
20 cm Ø



10164
Grande assiette ronde
26 cm Ø



Tous les articles en **gras** sont des produits de stock habituel. Consulter les couleurs disponibles.

Collection Minski

Collection avec une texture rayée originale qui apporte une petite touche rustique. Variété de tailles.



PT-6-MN-W

Assiette plate

16,5 cm Ø

 48

w



PT-7-MN-W

Assiette plate

19,1 cm Ø

 48

w



PT-10-MN-W

Assiette plate

26,7 cm Ø

 12

w



PT-129-MN-W

Plat

30,5 x 22,9 cm

 12

w



B-12-MN-W

Assiette creuse

23,5 cm Ø x 5,7 cm prof.
1,3 L

 12

w



B-16-MN-W

Assiette creuse

25,4 cm Ø x 6,3 cm prof.
1,6 L

 12

w



B-32-MN-W

Assiette creuse

26,7 cm Ø x 3,8 cm prof.
1,2 L

 12

w



B-10-MN-W

Bol

30,5 x 22,9 cm

 12

w



Tous les prix sont indiqués en P.V.P. unitaire.



Collection Nara

Élégante collection en mélamine noire mate.



P-875-BK
Assiette carrée
22,2 cm
 12
● BK



P-1000-BK
Assiette carrée
25,4 cm
 12
● BK



P-1175-BK
Assiette carrée
29,8 cm
 12
● BK



BF-6-BK
Assiette ronde
15,9 cm Ø
 12
● BK



BF-7-BK
Assiette ronde
18,4 cm Ø
 12
● BK



BF-9-BK
Assiette ronde
23,5 cm Ø
 12
● BK



BF-10-BK
Assiette ronde
25,4 cm Ø
 12
● BK

Tous les articles en **gras** sont des produits de stock habituel. Consulter les couleurs disponibles.

B-247-BK

Bol rond

710 ml

 12

● BK



B-549-BK

Bol rond

1.6 L

 12

● BK



RP-1145-BK

Plat rectangulaire

26,7 x 11,4 cm

 12

● BK



RP-1253-BK

Plat rectangulaire

30,5 x 13,3 cm

 12

● BK



RP-1490-BK

Plat rectangulaire

35,6 x 22,9 cm

 12

● BK



6020-BK

Cuillère

24 ml

 60

● BK



SD-3828-BK

Cupelle à sauce

14,8 ml

 24

● BK



SD-5525-BK

Cupelle à sauce deux compartiments

88,7 ml

 24

● BK



Rejoignez-nous



@DbmarkTweet



@dbmarkhosteleria



@dbmark_inst

Tous les prix sont indiqués en P.V.P. unitaire.

■ Ligne Viva México

Superbes jattes en mélamine pour vos sauces et tortillas mexicaines. Idéales pour les garnitures en restaurants mexicains. Plusieurs tailles disponibles.



MOJ-804-BK

Jatte

22,9 x 10,2 cm - 1,9 L



● BK

MOJ-803-BK

Jatte

19,7 x 7 cm - 769 ml



● BK



MOJ-802-BK

Jatte

12,7 x 6,3 cm - 296 ml



● BK



MOJ-801-BK

Jatte

10,2 x 3,8 cm - 118 ml



● BK

TS-800-

Récepteur pour tortillas

19,7 cm Ø x 3,2 cm prof.



● BK ● TE ● IV ● R ● BR

● VN



FTR1711

Support trois étages

métal noir

28,5 x 21 x 45 cm



557TCH

Récepteur pour tortillas

Gris charbon

18,5 cm Ø x 3 cm



CW30152

Faitout en fonte

26 x 20,5 x 4,5 cm

710 ml



Tous les articles en **gras** sont des produits de stock habituel. Consulter les couleurs disponibles.

■ Bols pour cuisine indienne

Récipients en acier inoxydable pour Kadai y Handi, plats traditionnels indiens.



839

Bol

Avec anses - 13 cm Ø
625 ml



● INOX.



840

Bol

Avec anses - 15 cm Ø
852 ml



● INOX.



848

Bol avec anses

Aspect cuivre
15 cm Ø - 852 ml



● INOX.



843

Bol

Aspect cuivre
15 cm Ø - 852 ml



● INOX.

■ Ligne Fuji



La ligne japonaise Fuji offre une saveur orientale à votre table avec l'élégance du rouge et noir.



B-124-F

Bol

15,2 cm Ø x 10,2 cm prof. - 1,1 L



B-125-F

Bol

17,1 cm Ø x 8,3 cm prof. - 1,2 L



B-47-F

Bol

19,0 cm Ø x 7 cm prof. - 1,3 L



B-129-F

Bol ondulé

8,9 cm Ø x 3,8 cm prof.
89 ml



B-123-F

Bol avec couvercle

12,1 cm Ø x 5,7 cm prof.
355 ml



B-720-BK

Bol avec couvercle

17,8 cm Ø x 5,7 cm prof.
520 ml



Tous les prix sont indiqués en P.V.P. unitaire.

■ Ligne Fuji (suite)



M-6030-BK

Cuillère
19 ml - noire



M-6030-W

Cuillère
19 ml - blanche



M-6030-RSP

Cuillère
19 ml - rouge



6026-RB

Cuillère
24 ml - noire et rouge



CHOPSTICKS

Baguettes
27,3 cm



STM-85-BK

Cuit vapeur noir
21,6 cm Ø x 8,3 cm prof.



Tous les articles en **gras** sont des produits de stock habituel. Consulter les couleurs disponibles.



Collection Better Burger

Ajoutez du style et de la diversion à votre service de restauration rapide haut de gamme avec notre nouvelle collection Better Burger. Les pièces sont disponibles en acier inoxydable ou en mélamine résistante. Parfait pour pubs, restaurants de grillades ou pour donner une touche élégante à vos présentations d'hamburgers, frites, nuggets, etc.



20025W

Boîte blanche pour hamburger

30,5 x 15 x 4 cm

6

○ W



20025BK

Boîte noire pour hamburger

30,5 x 15 x 4 cm

6

● BK



20026W

Boîte petite blanche pour frites

10 x 5 x 11 cm

6

○ W



20026BK

Boîte petite noire pour frites

10 x 5 x 11 cm

6

● BK



20027W

Boîte grande blanche pour frites

11,5 x 5,5 x 12,5 cm

6

○ W



20027BK

Boîte grande noire pour frites

11,5 x 5,5 x 12,5 cm

6

● BK



20028W

Cupelle petite blanche pour frites

12,5 x 8,5 x 3 cm

12

○ W



20028BK

Cupelle petite noire pour frites

12,5 x 8,5 x 3 cm

12

● BK



20029W

Cupelle grande blanche pour frites

18,5 x 12,5 x 4,5 cm

6

○ W



20029BK

Cupelle grande noire pour frites

18,5 x 12,5 x 4,5 cm

6

● BK

Tous les prix sont indiqués en P.V.P. unitaire.

Collection Better Burger (suite)



20030W

Verre blanc lisse
8 x 8 x 9 cm, 240 ml

12

○ w



20031W

Verre blanc lisse
9,5 x 9,5 x 13 cm, 475 ml

12

○ w



20032W

Verre blanc lisse
9,5 x 9,5 x 15,5 cm, 590 ml

12

○ w



123464

Verre blanc rayé
7 x 7 x 9,8 cm, 175 ml

12

○ w



123465

Verre blanc rayé
8,5 x 8,5 x 10 cm, 295 ml

12

○ w



123466

Verre blanc rayé
10 x 10 x 11,8 cm, 475 ml

12

○ w



Tous les articles en **gras** sont des produits de stock habituel. Consulter les couleurs disponibles.

Collection Better Burger (suite)

INOX



20003

Boîte pour hamburger

29,5 x 16 x 4 cm

12

INOX.



20004

Plateau grand

35,5 x 25,5 x 1,5 cm

12

INOX.



20005

Plateau petit

25,5 x 18 x 1,5 cm

12

INOX.

INOX

20006

Boîte petite pour fritures

11 x 3 x 11,5 cm

12

INOX.



20007

Boîte grande pour fritures

12,5 x 6,5 x 13,5 cm

12

INOX.



INOX

20008

Cupelle petite pour fritures

13 x 9 x 3 cm

12

INOX.



20009

Cupelle grande pour fritures

19 x 12,5 x 5 cm

12

INOX.



913A

Plat en aluminium

33 x 24 x 3 cm

12



913AS

Plat en acier aluminisé

33 x 24 x 3 cm

12



1006AS

Plat en acier aluminisé

25,5 x 15 x 2,5 cm

12

Tous les prix sont indiqués en P.V.P. unitaire.



20000

Spatule à servir courte, acier inoxydable avec manche en ABS

25,4 x 10,3 x 7,6 cm

12

INOX.

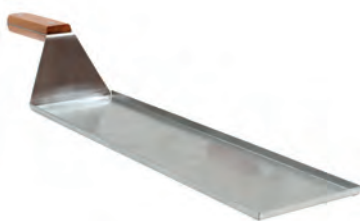

20001

Spatule à servir longue, acier inoxydable avec manche en ABS

40,6 x 8,8 x 6,4 cm

12

INOX.



INOX

20002

Spatule à servir des boissons, acier inoxydable avec manche en ABS

40,6 x 8,8 x 8,2 cm

12

INOX.

240002

Tasse 45 ml en mélamine

5 x 5 x 4 cm

12

W

240003

Tasse 60 ml en mélamine

5,5 x 5,5 x 4 cm

12

W

240004

Tasse 90 ml en mélamine

6 x 6 x 5 cm

12

W

240005

Tasse 180 ml en mélamine

8,5 x 8,5 x 6 cm

12

W

240006

Tasse 290 ml en mélamine

9 x 9 x 7 cm

12

W



240007

Saucière 45 ml en mélamine

6,5 x 5 x 3 cm

12

W

240008

Saucière 60 ml en mélamine

7 x 5,5 x 3 cm

12

W

240009

Saucière 90 ml en mélamine

7,5 x 6,5 x 3,5 cm

12

W

Tous les articles en **gras** sont des produits de stock habituel. Consulter les couleurs disponibles.



Poêles et Plats en mélamine

Améliorez la présentation de vos plats de résistance grâce à cette collection de casseroles et de plateaux en mélamine. Durables, légers et faciles à nettoyer. Ne convient pas aux micro-ondes ou fours.



MSKLT65

Poêle ronde en mélamine
24 x 16,5 x 4,5 cm



● BK



MSKLT85

Poêle ronde en mélamine
32,5 x 21,5 x 5,5 cm



● BK



MSV95

Plat ovale en mélamine
24 x 14,5 x 5 cm



● BK



MSV106

Plat ovale en mélamine
27,5 x 16,5 x 5 cm



● BK



MSSKLT5

Plat carré en mélamine
17 x 12,5 x 3,5 cm



● BK



MSSKLT65

Plat carré en mélamine
22,5 x 16,5 x 3,5 cm



● BK



MSSKLT85

Plat carré en mélamine
27,5 x 21,5 x 3,5 cm



● BK

Tous les prix sont indiqués en P.V.P. unitaire.

Cloche

Cloche en fibre de verre

- Résiste à des températures allant jusqu'à 149 °C.
- Reste froide au toucher, se manipule aisément.

- Plus légère et silencieuse que le métal.
- Compatible avec les fours à micro-ondes.



68VS
Cloche ronde
en fibre de verre
16,5 cm Ø x 5,6 cm
haut.
12
68VSNH*



86VS
Cloche ronde
en fibre de verre
21 cm Ø x 6,7 cm
haut.
12
86VSNH*



913VS
Cloche ronde
en fibre de verre
24,9 cm Ø x 6,8 cm
haut.
12
913VSNH*

99VS
Cloche ronde
en fibre de verre
24,3 cm Ø x 6,7 cm
haut.
12
99VSNH*

911VS
Cloche ronde
en fibre de verre
24,6 cm Ø x 7 cm
haut.
12
911VSNH*

100VS
Cloche ronde
en fibre de verre
25,4 cm Ø x 6,8 cm
haut.
12
100VSNH*

103VS
Cloche ronde
en fibre de verre
25,9 cm Ø x 6,8 cm
haut.
12
103VSNH*

105VS
Cloche ronde
en fibre de verre
26,2 cm Ø x 6,8 cm
haut.
12
105VSNH*

106VS
Cloche ronde
en fibre de verre
26,4 cm Ø x 7,2 cm
haut.
12
106VSNH*

1010VS
Cloche ronde
en fibre de verre
27 cm Ø x 6,8 cm
haut.
12
1010VSNH*

1012VS
Cloche ronde
en fibre de verre
27,3 cm Ø x 6,8 cm
haut.
12
1012VSNH*

1014VS
Cloche ronde
en fibre de verre
27,6 cm Ø x 6,8 cm
haut.
12
1014VSNH*

116VS
Cloche ronde
en fibre de verre
28,9 cm Ø x 8,1 cm
haut.
12
116VSNH*

120VS
Cloche ronde
en fibre de verre
30,5 cm Ø x 7,3 cm
haut.
12
120VSNH*

124VS
Cloche ronde
en fibre de verre
31,1 cm Ø x 7,3 cm
haut.
12
124VSNH*

85SFVS
Cloche carrée
en fibre de verre
20,9 cm x 7 cm haut.
12
85SFVSNH*

978SFVS
Cloche carrée
en fibre de verre
25,4 cm x 7 cm haut.
12
978SFVSNH*



Couleurs disponibles : ● 191 ● 380 ● 101

** Disponible aussi sans ouverture d'aération pour plus de sécurité.

Tous les articles en **gras** sont des produits de stock habituel. Consulter les couleurs disponibles.



Verres de SAN

Plus économique que le polycarbonate mais tout aussi efficace lorsqu'il s'agit d'éviter les risques dans les écoles, les ehpad ou zone de piscine. Le SAN est un matériau résistant aux cassures. Choisissez parmi les différents designs attrayants que nous vous présentons.

Les liquides en copolymère SAN ne doivent pas dépasser 85 °C.



SW-1460-CL
Verre Stemless
265 ml - 7,6 cm haut.

 24

 CL



SW-1461-CL
Verre Stemless
408 ml - 11,3 cm haut.

 24

 CL



SW-1448-1-CL
Verre L7
161 ml - 8,9 cm haut.

 24

 CL



SW-1439-1-CL
Verre L7
281 ml - 8,3 cm haut.

 24

 CL



SW-1440-1-CL
Verre L7
370 ml - 8,9 cm haut.

 24

 CL



SW-1441-1-CL
Verre L7
429 ml - 12,7 cm haut.

 24

 CL



SW-1442-1-CL
Verre L7
503 ml - 14 cm haut.

 24

 CL

Tous les prix sont indiqués en P.V.P. unitaire.

Verres de SAN (suite)

Les liquides en copolymère SAN ne doivent pas dépasser 85 °C.



SW-1443-1-CL

Verre Roc N' Roll

163 ml - 10,2 cm haut.

 24

CL



SW-1423-1-SAN-CL

Verre Roc N' Roll

266 ml - 8,6 cm haut.

 24

CL



SW-1429-1-SAN-CL

Verre Roc N' Roll

316 ml - 8,9 cm haut.

 24

CL



SW-1444-1-CL

Verre Roc N' Roll

361 ml - 17,8 cm haut.

 24

CL



SW-1424-1-SAN-CL

Verre Roc N' Roll

370 ml - 12,1 cm haut.

 24

CL



SW-1426-1-SAN-CL

Verre Roc N' Roll

444 ml - 14 cm haut.

 24

CL

GUIDE DE CASIERS POUR COUPES ET VERRES

2021



GUIDE DE CASIERS CAMRACK DE CAMBRO POUR COUPES ET VERRES

Plus de 4.000 modèles de coupes et verres de toutes marques avec le casier de lavage qui lui correspond ainsi que son prix.

Un outil utile qui vous permettra de gagner du temps et facilitera la recherche du casier de lavage idéal pour votre verrerie.

Télécharger-le sur www.dbmark.com

Tous les articles en **gras** sont des produits de stock habituel. Consulter les couleurs disponibles.

Verres del Mar

Les liquides en copolymère SAN ne doivent pas dépasser 85 °C.



D8-

Verre del Mar

237 ml - 10,6 cm haut.



D12-

Verre del Mar

355 ml - 12 cm haut.



D14-

Verre del Mar

414 ml - 8,3 cm haut.



D16-

Verre del Mar

473 ml - 15,1 cm haut.



D24-

Verre del Mar

710 ml - 16,8 cm haut.



Couleur disponible : ○ 152 | Couleurs sur commande : ● 156 ● 608 ● 609

Verres Lido

Les liquides en copolymère SAN ne doivent pas dépasser 85 °C.



LDT5-

Verres Lido

150 ml - 9,4 cm haut.



LDT6-

Verres Lido

177 ml - 9,4 cm haut.



LDT9-

Verres Lido

266 ml - 9,4 cm haut.



LDT10-

Verres Lido

300 ml - 11,4 cm haut.



LDT12-

Verres Lido

355 ml - 12,5 cm haut.



LDT16-

Verres Lido

480 ml - 13,5 cm haut.



LDT22-

Verres Lido

650 ml - 16,8 cm haut.



Couleurs disponibles : ○ 152. Los modelos LDT6 y LDT9 incorporan una sutil graduación para su uso en sanidad.

Tous les prix sont indiqués en P.V.P. unitaire.

Verres Newport

Les liquides en copolymère SAN ne doivent pas dépasser 85 °C.



NT5-

Verre Newport

189 ml - 9,4 cm

36



NT8-

Verre Newport

228 ml - 10,2 cm

36



NT9-

Verre Newport

275 ml - 8,4 cm

36



NT10-

Verre Newport

300 ml - 11,6 cm

36



NT12-

Verre Newport

373 ml - 13 cm

36



NT14-

Verre Newport

414 ml - 12,7 cm

36



NT16-

Verre Newport

485 ml - 14,6 cm

36



NT20-

Verre Newport

650 ml - 16,5 cm

36

Couleurs disponibles pour NT5, NT8, NT9, NT10, NT12: ○ 152. Couleurs disponibles : ○ 152 ● 150 ● 401



Tous les articles en **gras** sont des produits de stock habituel. Consulter les couleurs disponibles.

Verres Laguna

Les liquides en copolymère SAN ne doivent pas dépasser 85 °C.



LT6

Verre Laguna

177,4 ml - 10,7 cm

36

Couleurs disponibles : 152 427



LT8

Verre Laguna

236,6 ml - 10,9 cm

36



LT10

Verre Laguna

295,7 ml - 12,1 cm

36



LT12-

Verre Laguna

354,9 ml - 12,7 cm

36



LT14-

Verre Laguna

414 ml - 13,1 cm

36



LT16-

Verre Laguna

473,2 ml - 14 cm

36



LT22-

Verre Laguna

650,6 ml - 15,4 cm

36

Couleurs disponibles pour LT8, LT10, LT12, LT22: 152. Couleurs disponibles : 152 427

Verres de chupito



Les liquides en copolymère SAN ne doivent pas dépasser 85 °C.



SW-1433-1-CL

Verre à shot

30 ml - 5,7 cm haut. - SAN

24

CL



SW-1427-1-CL

Verre à shot

32,5 ml - 7 cm haut. - SAN

24

CL



SW-1425-1-CL

Verre à shot

35,5 ml - 5 cm haut. - SAN

24

CL

Tous les prix sont indiqués en P.V.P. unitaire.

Verres de chupito (suite)



SW-1431-1-CL

Verre à shot

35,5 ml - 7,6 cm haut. - SAN

48

CL



SW-1409-1-CL

Verre à shot

53,2 ml - 5,7 cm haut. - SAN

24

CL



SW-1416-1-CL

Verre à shot

59 ml - 11,4 cm haut. - SAN

24

CL



SW-1408-1-CL

Verre à shot

89 ml - 9,5 cm haut. - SAN

24

CL

Verres Colorware

Les liquides en copolymère SAN ne doivent pas dépasser 85 °C.



500P-

Verre Colorware

154 ml - 9,2 cm haut.

72



800P-

Verre Colorware

231 ml - 10,2 cm haut.

72



900P-

Verre Colorware

287 ml - 8,25 cm haut.

72



950P-

Verre Colorware

290 ml - 11,1 cm haut.

72



1200P-

Verre Colorware

373 ml - 13,2 cm haut.

72



1600P-

Verre Colorware

485 ml - 14,6 cm haut.

72



2000P-

Verre Colorware

650 ml - 16,5 cm haut.

72

Couleurs disponibles pour 1200P: 152 | Couleurs disponibles : 153 401 156

Tous les articles en **gras** sont des produits de stock habituel. Consulter les couleurs disponibles.

Verres Tahití et Bahama

Les liquides en copolymère SAN ne doivent pas dépasser 85 °C.



2206-1-

Verre Tahití

195 ml - 8 cm haut.



Couleur disponible : CL

Couleurs sur commande :

BL R JA



2209-1-

Verre Tahití

353 ml - 8,9 cm haut.



Couleur disponible : CL

Couleurs sur commande :

BL R JA



2211-1-

Verre Tahití

407 ml - 10,5 cm haut.



Couleur disponible : CL

Couleurs sur commande :

BL JA



2212-1-

Verre Tahití

411 ml - 12,4 cm haut.



Couleur disponible : CL

Couleurs sur commande :

BL JA



2216-1-

Verre Tahití

494 ml - 13,3 cm haut.



Couleur disponible : CL

Couleurs sur commande :

BL R JA



2220-1-

Verre Tahití

683 ml - 14,6 cm haut.



Couleur disponible : CL

Couleurs sur commande :

BL R JA



2221-1-CL

Verre Tahití

670 ml - 16,5 cm haut.



Couleur disponible : CL



2224-1-

Verre Tahití

819 ml - 15,2 cm haut.



Couleur disponible : CL

Couleurs sur commande :

BL R JA



2232-1-

Verre Tahití

1 L - 18,7 cm haut.



Couleur disponible : CL

Couleurs sur commande :

BL R



9955-1-

Verre Bahama

191 ml - 7,6 cm haut.



Couleur disponible : CL

Couleurs sur commande :

BL R



9907-1-

Verre Bahama

226 ml - 8,3,9 cm haut.



Couleur disponible : CL

Couleurs sur commande :

BL



9909-1-

Verre Bahama

280 ml - 9 cm haut.



Couleur disponible : CL

Couleurs sur commande :

BL R



9910-1-

Verre Bahama

367 ml - 12,1 cm haut.



Couleur disponible : CL

Couleurs sur commande :

BL R JA



9912-1-

Verre Bahama

392 ml - 10,2 cm haut.



Couleur disponible : CL

Couleurs sur commande :

BL R

Tous les prix sont indiqués en P.V.P. unitaire.



9914-1-

Verre Bahama

470 ml - 12,7 cm haut.

72

Couleur disponible : CL

Couleurs sur commande :

BL JA



9916-1-

Verre Bahama

559 ml - 15,2 cm haut.

72

Couleur disponible : CL

Couleurs sur commande :

BL R JA



9920-1-

Verre Bahama

627 ml - 15,5 cm haut.

72

Couleur disponible : CL

Couleurs sur commande :

BL R JA



9921-1-CL

Verre Bahama

627 ml - 15,5 cm haut.

72

Couleur disponible : CL



9922-1-

Verre Bahama

757ml - 16,8 cm haut.

72

Couleur disponible : CL

Couleurs sur commande :

BL R JA



9932-1-

Verre Bahama

1 L - 18,4 cm haut.

72

Couleur disponible : CL

Tous les articles en **gras** sont des produits de stock habituel. Consulter les couleurs disponibles.

Copas de SAN

Sécurité maximale pour servir une coupe de vin, de champagne ou un martini. Éléance sans risques.

Les liquides en copolymère SAN ne doivent pas dépasser 85 °C.



SW-1406-1-SAN-CL

Coupe de vin
222 ml - 14 cm haut.

 24

CL



SW-1404-1-SAN-CL

Coupe de vin
260 ml - 17,8 cm haut.

 24

CL



SW-1420-1-SAN-CL

Flûte à champagne
177 ml - 21 cm haut.

 24

CL



SW-1401-1-SAN-CL

Flûte à champagne
177 ml - 21 cm haut.

 24

CL



SW-1430-1-CL

Coupe de martini
89 ml - 9,5 cm haut.

 24

CL



SW-1402-1-SAN-CL

Coupe de martini
177 ml - 14,6 cm haut.

 24

CL



SW-1407-1-SAN-CL

Coupe de martini
311 ml - 19,1 cm haut.

 24

CL



SW-1419-1-SAN-CL

Coupe de martini
1,4 L - 22,9 cm haut.

 3

CL



SW-1403-1-SAN-CL

Coupe margarita
355 ml - 15,2 cm haut.

 24

CL



SW-1405-1-SAN-CL

Coupe margarita
513 ml - 16 cm haut.

 24

CL



SW-1432-1-CL

Coupe margarita
964 ml - 17,2 cm haut.

 12

CL



SW-1415-1-SAN-CL

Coupe margarita
1,2 L - 21,6 cm haut.

 12

CL

Tous les prix sont indiqués en P.V.P. unitaire.

Chopes de bière de SAN

Rien de mieux que de savourer le goût d'une bonne bière dans le jardin, la piscine ou le bateau. Sécurité maximale avec nos pichets de bière SAN.

Les liquides en copolymère SAN ne doivent pas dépasser 85 °C.



00082-1-SAN-CL

Chope de bière

296 ml - 12,7 cm haut.

 24

CL



00084-1-SAN-CL

Chope de bière

365 ml - 14 cm haut.

 24

CL



00086-1-SAN-CL

Chope de bière

525 ml - 15,9 cm haut.

 24

CL



00085-1-SAN-CL

Chope de bière

608 ml - 15,9 cm haut.

 12

CL



00083-1-SAN-CL

Chope de bière

621 ml - 14 cm haut.

 24

CL

P-12-1-CL

Verre Pilsner

380 ml - 18,4 cm haut.

 24

CL



SW-1417-1-SAN-CL

Verre Pilsner

673 ml - 22,9 cm haut.

 24

CL



Tous les articles en **gras** sont des produits de stock habituel. Consulter les couleurs disponibles.



■ Récipients à desserts

Ces jolis récipients vous permettront de servir des glaces, des smoothies, etc. dans des endroits où le verre n'est pas autorisé, tel que dans les piscines.



DG3CW

Verrine

Carrée - 100 ml - 7,7 cm - PC

 72

135



SW-1434-CL

Verrine

Triangulaire - 98 ml - 6,9 cm - SAN

 24

CL



SW-1435-CL

Verrine

Carrée - 93 ml - 7,4 cm - SAN

 24

CL



GB850CW

Coupe en polycarbonate

266 ml - 15,9 cm

 24

135



GB1200CW

Coupe en polycarbonate

378 ml - 19,4 cm

 24

135



HUR-1-CL

Coupe en polycarbonate

473 ml - 20,3 cm

 24

CL

Tous les prix sont indiqués en P.V.P. unitaire.

■ Récipients à desserts (suite)



SW-1467-CL

Coupe en polycarbonate
586 ml - 18 cm

☑ 24
○ CL



HUR-20-PC-CL

Coupe en polycarbonate
621 ml - 23,2 cm

☑ 24
○ CL



SW-1413-1-CL

Coupe en SAN
266 ml - 14 cm

☑ 24
○ CL



SW-1414-1-CL

Coupe en SAN
376 ml - 17,8 cm

☑ 24
○ CL



GOB-12-1-SAN-CL

Coupe en SAN
365 ml - 15,2 cm

☑ 24
○ CL



GOB-20-1-SAN-CL

Coupe en SAN
679 ml - 17,8 cm

☑ 12
○ CL



SW-1428-1-SAN-CL

Coupe en SAN
1,1 L - 20,3 cm

☑ 12
○ CL



ICM-24-CL

Coupe à glace
8,9 cm Ø - 148 ml

☑ 24
○ CL



ICM-25-CL

Coupe à glace
9,5 cm Ø - 177 ml

☑ 24
○ CL



ICM-26-2-CL

Coupe à glace
10,2 cm Ø - 237 ml

☑ 24
○ CL



ICM-27-CL

Coupe à glace
24,1 x 11,4 cm - 237 ml

☑ 24
○ CL

MAS-3-CL

Mason jar - 489 ml - 12,7 cm

☑ 24
○ CL



SW-1449-CL

Irish coffee - 296 ml - 14,6 cm

☑ 24
○ CL



Tous les articles en **gras** sont des produits de stock habituel. Consulter les couleurs disponibles.



■ Pichets en polycarbonate

Sûres, hygiéniques, résistantes et attrayantes. Les carafes en polycarbonate sont idéales pour le service de boissons dans tous types de salles, réfectoires, restaurants etc. Vous trouverez sans doute la plus adaptée à vos besoins dans la sélection suivante.



P320CW

Pichet Camwear
0,95 L - 17 cm haut.

☑ 6
○ 135



P34CW

Pichet Camwear
1 L - 16,8 cm haut.

☑ 6
○ 135



P34LCW

Pichet Camwear
Couvercle pour P34CW

☑ 6
○ 135

P480CW

Pichet Camwear
1,4 L - 20 cm haut.

☑ 6
○ 135



PL60CW

Pichet Camwear
1,8 L - 20 cm haut.

☑ 6
○ 135



Tous les prix sont indiqués en P.V.P. unitaire.

■ Pichets en polycarbonate (suite)



PE600CW

Pichet Camwear
1,8 L - 20 cm haut.



○ 135

sans
BPA



P600CW

Pichet Camwear
1,8 L - 20,5 cm haut.



○ ●



P60CW

Pichet Camwear
1,8 L - 23 cm haut.



○ 135



P64CW

Pichet Camwear
1,9 L - 23,5 cm haut.



○ 135



PC64CW

Pichet Camwear
1,9 L - 24,8 cm haut.
avec couvercle



○ 135



P-4072-PC-CL

Pichet Tahiti
2,1 L - 21,6 cm haut.



○ CL



P-4091-PC-

Pichet Tahiti
2,7 L - 22,2 cm haut.



○ CL ● A



P-4090-PC-

Pichet Tahiti
2,7 L - 22,2 cm haut.



○ CL ● A



P-4050-PC-CL

Pichet avec couvercle
1,5 L - 28,6 cm haut.



○ CL



Tous les articles en **gras** sont des produits de stock habituel. Consulter les couleurs disponibles.

Petits pichets en cuivre

Ajoutez une touche rétro à vos cocktails. Ces pichets offrent aussi une alternative pour des présentations spéciales de boissons chaudes, comme le café ou le chocolat.



CPRMUG-01

Petit pichet en cuivre

Brossé
503 ml
11,9 cm Ø x 8,8 cm haut.



CPRMUG-02

Petit pichet en cuivre

Martelé
503 ml
11,9 cm Ø x 8,8 cm haut.



Coupes de metal

Une présentation très spéciale pour vos cocktails ou vos desserts. Ces coupes maintiennent les boissons froides plus longtemps que le verre.



SW-1612-SS

Coupe en métal

12,5 cm Ø x 18,2 cm haut.
380 ml



● SS



SW-1612-CPR

Coupe en métal

12,5 cm Ø x 18,2 cm haut.
380 ml



● CPR



Support de dégustation

Un option attrayante pratique pour servir condiments et garnitures.



HFLGLASS5

Set de dégustation

Set dégustation
5 x 7 cl
28,9 x 7,5 x 8,5 cm



WF200BK*

Set de dégustation

Pour 3 condiments,
60 - 90 ml, 5,5 cm Ø,
Design à étages - 19 x 18
x 36 cm



● BK

* Ramequins non inclus



Tous les prix sont indiqués en P.V.P. unitaire.



Carafes

Apportent une touche élégante et moderne, sans crainte de désagrément grâce à leur grande résistance.



BW-1025-PC-CL

Carafe avec bec verseur
0,43 L - 15,2 cm haut.

12

CL

BW-1050-PC-CL

Carafe avec bec verseur
0,74 L - 21,6 cm haut.

12

CL

BW-1100-PC-CL

Carafe avec bec verseur
1,4 L - 27,9 cm haut.

12

CL

BW-1892-CL

Carafe avec bec verseur
1,9 L - 30,7 cm haut.

12

CL



sans
BPA



WW250

Carafe avec couvercle
0,25 L - 15,9 cm haut.

6

135

sans
BPA



WW500

Carafe avec couvercle
0,5 L - 20 cm haut.

6

135

sans
BPA



WW1000

Carafe avec couvercle
1 L - 24,8 cm haut.

6

135

sans
BPA



WW1500

Carafe avec couvercle
1,5 L - 25,4 cm haut.

6

135

Tous les articles en **gras** sont des produits de stock habituel. Consulter les couleurs disponibles.

Carafes (suite)



WW1000LS

Couvercle

Pour 0,5 / 1,5 / 1 L

12

148



WW1000L

Couvercle

Pour 0,5 / 1,5 / 1 L

12

148



WW250L

Couvercle

Pour 0,25 L

12

148



Carafes thermiques



1001301

Carafe thermique
Noir - 590 ml -
mécanisme pousse

1

BK



1001401

Carafe thermique
Noir - 1,2 L -
mécanisme pousse

1

BK



1001402

Carafe thermique
Blanche - 1,2 L -
mécanisme pousse

1

WH



Carafes en acier inoxydable

300

Carafe en acier inoxydable

Avec passoire à glaçons -
miroir
22 x 12,5 x 21,5 cm
2,3 L

1

INOX.



RP68

Carafe en acier inoxydable

Avec passoire à glaçons -
martelé
19,5 x 14 x 21,5 cm
2,3 L

1

INOX.



Tous les prix sont indiqués en P.V.P. unitaire.



■ Ramequins

Tirez le meilleur parti de cet ustensile versatile, agréable et peu coûteux. Disponibles en différentes tailles, couleurs et formes.



RAM2R

Ramequin rond côté

60 ml - 7 x 7 x 3 cm

12

○ W ● BK ● R ● GN ● X



RAM3R

Ramequin rond côté

90 ml - 8,5 x 8,5 x 3,5 cm

12

○ W ● BK ● R ● GN ● X



RAM4R

Ramequin rond côté

120 ml - 9 x 9 x 4 cm

12

○ W ● BK ● R ● GN ● X



RAM1F

Ramequin rond côté

30 ml - 5,5 x 5,5 x 2,5 cm

12

○ W ● BK



RAM15

Ramequin rond

45 ml - 6 x 6 x 3,5 cm

12

○ W ● BK ● B



RAM15F

Ramequin rond côté

45 ml - 6 x 6 x 3,5 cm

12

○ W ● BK ● B



RAM2

Ramequin rond

60 ml - 7 x 7 x 4 cm

12

○ W ● BK ● B

Tous les articles en **gras** sont des produits de stock habituel. Consulter les couleurs disponibles.

■ Ramequins (suite)



RAM2BU

Ramequin rond

60 ml - 7 x 7 x 4 cm

🍽️ 12

● BU



RAM2F

Ramequin rond côtelé

60 ml - 7 x 7 x 4 cm

🍽️ 12

○ W ● BK ● B



RAM3

Ramequin rond

90 ml - 8 x 8 x 4,5 cm

🍽️ 12

○ W ● BK



RAM3F

Ramequin rond côtelé

90 ml - 8 x 8 x 4,5 cm

🍽️ 12

○ W ● BK ● B



RAM4BK

Ramequin rond

120 ml - 9 x 9 x 4 cm

🍽️ 12

● BK



RAM4BU

Ramequin rond

120 ml - 9 x 9 x 4 cm

🍽️ 12

● BU



RAM6

Ramequin rond

180 ml - 10 x 10 x 4,5 cm

🍽️ 12

● BK ● B



MB22

Ramequin collection Frostone

45 ml - rond ovale

9 x 6,5 x 4,5 cm

🍽️ 12

○ W



MB32

Ramequin collection Frostone

60 ml - rond lisse

8,5 x 8,5 x 4 cm

🍽️ 12

○ W



MB63

Ramequin collection Frostone

120 ml - rectangulaire deux compartiments.

14,5 x 7 x 2,5 cm

🍽️ 12

○ W

Tous les prix sont indiqués en P.V.P. unitaire.

■ Ramequins (suite)



RAMS2

Ramequin côtelé carré

60 ml - 7 x 7 x 4 cm

12

W BK



RAMS3

Ramequin côtelé carré

90 ml - 8 x 8 x 4 cm

12

W BK



RAMS4

Ramequin côtelé carré

120 ml - 8 x 8 x 4,5 cm

12

W BK



4-84105

Ramequin acier inoxydable

7 cm Ø x 1,6 cm haut.
- 44 ml

24

INOX.



4-84100

Ramequin acier inoxydable

7 cm Ø x 2,5 cm haut.
- 59 ml

24

INOX.



4-84111

Ramequin acier inoxydable

7 cm Ø x 4,4 cm haut.
- 118 ml

24

INOX.



4-89444

Ramequin acier inoxydable

10,2 cm Ø x 5,7 cm haut.
- 177 ml

24

INOX.



4-89448

Ramequin acier inoxydable

11,4 cm Ø x 7,6 cm haut.
- 414 ml

24

INOX.



5063

Ramequin acier inoxydable

8 x 8 x 4 cm - 120 ml

12

INOX.



5064

Ramequin acier inoxydable

9,5 x 9,5 x 4,5 cm - 180 ml

12

INOX.



5066

Ramequin acier inoxydable

6 x 6 x 2,5 cm - 45 ml

12

INOX.



Tous les articles en **gras** sont des produits de stock habituel. Consulter les couleurs disponibles.



■ Ramequins (suite)



5067

Ramequin acier inoxydable

6 x 6 x 4 cm - 75 ml

🍽️ 12

● INOX.



5068

Ramequin acier inoxydable

6,5 x 6,5 x 3 cm - 60 ml

🍽️ 72

● INOX.



5071

Ramequin acier inoxydable

7 x 7 x 4 cm - 90 ml

🍽️ 12

● INOX.



5072

Ramequin acier inoxydable

7,5 x 7,5 x 5 cm - 120 ml

🍽️ 12

● INOX.



5073

Ramequin acier inoxydable

8 x 8 x 5,5 cm - 180 ml

🍽️ 12

● INOX.



240010

Ramequin acier inoxydable

6,7 x 6,7 x 4 cm - 90 ml

🍽️ 12

● INOX.

Tous les prix sont indiqués en P.V.P. unitaire.

■ Cônes et cylindres pour apéritifs

Une façon originale et élégante de présenter des apéritifs.



AC885H

Cylindre pour apéritif

8 x 8,5 cm - martelé - 415 ml



● INOX.



AC885S

Cylindre pour apéritif

8 x 8,5 cm - satiné - 415 ml



● INOX.



AC885R

Cylindre pour apéritif

8 x 8,5 cm - grain de riz - 415 ml



● INOX.



AC57

Cône pour apéritif

12 x 12 x 18 cm - acier chromé noir



● INOX.



AC59

Cône pour apéritif

13 x 13 x 24 cm - acier chromé noir



● INOX.



BK157

Cône pour apéritif

12 x 17 cm - acier chromé noir



● INOX.



ACR59

Cône pour apéritif avec ramequin de 90 ml

13,5 x 18 x 24 cm - acier chromé noir



● INOX.



ACR57

Cône pour apéritif avec ramequin de 90 ml

21 x 12,5 x 18 cm - acier chromé noir



● INOX.



ACR259

Cône pour apéritif avec deux ramequins de 90 ml

13,5 x 28 x 24 cm - acier chromé noir



● INOX.



Tous les articles en **gras** sont des produits de stock habituel. Consulter les couleurs disponibles.

■ Cône pour apéritif empilables

Cône pour apéritifs empilables, pratiques pour que le manque d'espace ne soit pas un problème.

4-83888

Cône pour apéritif empilables

12,7 cm x 15,2 cm
acier inoxydable

🍷 4

● INOX.



4-33888

Cône pour apéritif empilables

12,7 cm x 15,2 cm
fer recouvert de teflon

🍷 4

● INOX.



■ Mini paniers et mini faitouts

Pièces de présentations jolies et originales qui fourniront une touche spéciales à votre table.



4-81865

Mini panier avec deux anses

10,2 x 8,3 x 5,7 cm

🍷 24

● INOX.



4-81860

Mini panier avec manche
de 12 cm

10,2 x 8,3 x 5,7 cm

🍷 48

● INOX.



4-81868

Mini panier avec manche
de 15 cm

12,7 x 10,1 x 8,3 cm

🍷 24

● INOX.



4-818610

Mini panier avec manche
de 12,7 cm

20,3 x 15,2 x 7,6 cm

🍷 24

● INOX.



4-80910

Mini faitout avec couvercle satiné

11,7 cm Ø x 7,6 cm haut. - 295,7 ml

🍷 1

● INOX.



4-80555

Mini faitout avec couvercle effet miroir

12,7 cm Ø x 6,3 cm haut. - 414 ml

🍷 1

● INOX.



4-80999

Mini faitout avec couvercle satiné

12,7 cm Ø x 6,3 cm haut. - 414 ml

🍷 1

● INOX.

Tous les prix sont indiqués en P.V.P. unitaire.



Supports à tacos

Maintenez vos tacos verticalement en évitant qu'ils se ramolissent ou se défassent au moment du service.



4-81855

Support à tacos

Pour 2 tacos
10,8 cm x 8,9 cm

48

INOX.



4-81833

Support à tacos

Pour 3 tacos
17,1 cm x 8,3 cm

48

INOX.



4-81823

Support à tacos

Pour 2-3 mini tacos
10,2 cm x 5,1 cm

48

INOX.



4-81858

Support à tacos

Pour 3-4 tacos
15,2 cm x 6,4 cm
acier inoxydable

48

INOX.



4-81859

Support à tacos

Pour 4-5 tacos
19,7 cm x 6,4 cm
acier inoxydable

48

INOX.

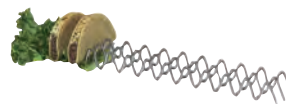

4-81856

Support à tacos

Pour 11-12 tacos
47 cm x 6,4 cm
acier inoxydable

12

INOX.



4-81828

Support à tacos

Pour 11-12 mini tacos
38,1 cm x 5,1 cm
acier inoxydable

12

INOX.

Tous les articles en **gras** sont des produits de stock habituel. Consulter les couleurs disponibles.

Supports à tacos (suite)



TRW12

Support à tacos

Pour 1 ou 2 tacos
9 x 5,5 x 4 cm
acier inoxydable

12

INOX.



TRW23

Support à tacos

Pour 2 ou 3 tacos
14 x 5,5 x 4 cm
acier inoxydable

12

INOX.



TRW34

Support à tacos

Pour 3 ou 4 tacos
19 x 5,5 x 4 cm
acier inoxydable

12

INOX.



TRS12

Support à tacos

Pour 1 ou 2 tacos
9 x 5,5 x 4 cm
acier inoxydable

12

INOX.



TRS23

Support à tacos

Pour 2 ou 3 tacos - 14 x 5,5 x 4 cm
acier inoxydable

12

INOX.



TRS34

Support à tacos

Pour 3 ou 4 tacos - 19,5 x 5,5 x 4 cm
acier inoxydable

12

INOX.



TRSP12

Support à tacos

Pour 1 ou 2 tacos - 9 x 5,5 x 4 cm
acier inoxydable avec décoration

12

INOX.

TRSP23

Support à tacos

Pour 2 ou 3 tacos - 14 x 5,5 x 4 cm - acier inoxydable avec décoration

12

INOX.



TRSP34

Support à tacos

Pour 3 ou 4 tacos - 19,5 x 5,5 x 4 cm - acier inoxydable avec décoration

12

INOX.



937

Support de préparation

Pour 7 hot-dogs - acier inox.
46,5 x 10 x 5,5 cm

1

INOX.



BBQ48

Support de préparation

Pour 4 tacos - acier inox.
28,5 x 15 x 5 cm

6

INOX.



Tous les prix sont indiqués en P.V.P. unitaire.



Nouveauté

Support à tacos jetable

Support à tacos jetable en bois de peuplier en forme de X.



10516

Support à tacos jetable en bois de peuplier en forme de X.
Pack de 50 pièces.

8,5 x 6 x 4,5 cm

🗑️ 1



Taco Taxi

Parfaitement conçus pour préparer et présenter des tacos. Les supports à tacos en mélamine sont aptes aux températures jusqu'à 100 °C.



10277BK

Support à tacos

1-2 tacos, 9 x 5,5 x 4 cm

🗑️ 12

● BK



10278BK

Support à tacos

2-3 tacos, 14,5 x 5,5 x 4 cm

🗑️ 12

● BK



10279BK

Support à tacos

3-4 tacos, 19,5 x 5,5 x 4 cm

🗑️ 12

● BK



Tous les articles en **gras** sont des produits de stock habituel. Consulter les couleurs disponibles.



Seaux

Petits seaux en acier inoxydable, conçus pour présenter de façon originale n'importe quel ingrédient ou sauce sur votre table. D'un grand réalisme, l'apparence est la même que celle de ses aînés.



4-80800

Seau

6,3 cm Ø x 7 cm haut. - 156 gr

12

INOX.



4-80810

Seau

8,9 cm Ø x 8,9 cm haut. - 340 gr

12

INOX.



4-80808

Seau

8,9 cm Ø x 10,1 cm haut. - 340 gr

12

INOX.



4-80818

Seau

11,4 cm Ø x 11,4 cm haut. - 623 gr

12

INOX.



4-80822

Seau

17,8 cm Ø x 15,2 cm haut. - 1,3 kg

12

INOX.



4-80824

Seau

20,3 cm Ø x 17,8 cm haut. - 4 kg

12

INOX.

Tous les prix sont indiqués en P.V.P. unitaire.

Seaux (suite)



PHB35

Seau

9 x 9 x 7,5 cm - 240 ml
Effet miroir

12

INOX.



PH35

Seau

9 x 6 x 8,5 cm - 240 ml
Texture martelée

12

INOX.



GT33

Seau

9,5 x 8,2 x 7,6 cm - 265 ml
Texture petits cailloux

12

INOX.



GT44

Seau

11,4 x 10,1 x 9,5 cm - 490 ml
Texture petits cailloux

12

INOX.



GT87

Seau

23,4 x 20,9 x 17,7 cm - 5,7 L
Texture petits cailloux

4

INOX.



GTSS33

Seau

9,5 x 8 x 8 cm - 265 ml
Texture briques

12

INOX.



GTSS44

Seau

12 x 11 x 9,5 cm - 490 ml
Texture briques

12

INOX.



GTSS87

Seau

23,5 x 21 x 18 cm - 5,7 L
Texture briques

4

INOX.



Tous les articles en **gras** sont des produits de stock habituel. Consulter les couleurs disponibles.

Collection Brickhouse

Pièces originales en acier inoxydable texture briques, avec une variété de styles et tailles.



GPSS8

Plat rond
21 x 21 x 4,5 cm

12

INOX.



GPSS10

Plat rond
27,5 x 27,5 x 4 cm

12

INOX.



GPSS96

Plat ovale
25 x 15 x 6 cm

12

INOX.



GPSS129

Plat ovale
31 x 22 x 6 cm

12

INOX.



GPSS90

Plat rectangulaire
25 x 17 x 4,5 cm

12

INOX.



GPSS120

Plat rectangulaire
31 x 23,5 x 4,5 cm

12

INOX.



GPSSCADDY

Panier à couverts
27,5 x 21 x 12 cm

4

INOX.

GTSS33

Seau
9,5 x 8 x 8 cm - 265 ml

12

INOX.

GTSS44

Seau
12 x 11 x 9,5 cm - 490 ml

12

INOX.

GTSS87

Seau
23,5 x 21 x 18 cm - 5,7 L

12

INOX.



Tous les prix sont indiqués en P.V.P. unitaire.



Nouveauté

Collection Lattice

Disponible dans une variété de styles et de tailles. Ces pièces ajoutent une touche décontractée à vos plats principaux et accompagnements. Fabrication en acier inoxydable avec un motif de rotin tissé en relief.



10034
Plat rond
20,6 Ø x 3,8 cm



INOX.



10035
Plat rond
26,6 Ø x 3,8 cm



INOX.



10036
Plat ovale
24,1 x 15,2 x 3,8 cm



INOX.



10037
Plat ovale
30,5 x 22,8 x 5,3 cm



INOX.



10038
Plat rectangulaire
24,1 x 16,5 x 3,8 cm



INOX.



10039
Plat rectangulaire
30,5 x 22,8 x 3,8 cm



INOX.

Tous les articles en **gras** sont des produits de stock habituel. Consulter les couleurs disponibles.

Collection Lattice (cont.)



10041
Seau
Rond, 10 Ø x 9,5 cm
12
INOX.



10042
Emballage pour frites et fritures
Rond, 9,5 Ø x 12 cm
12
INOX.



10043
Emballage pour frites et fritures
Carré, 10 x 10 x 8,8 cm
12
INOX.



10040
Porte-couverts rectangulaire
27,3 x 21,5 x 12 cm
1
INOX.



10486
Jeu à snacks, quatre pièces
Inclus : 1 plat (10488)
et 3 verres (10487)
1
INOX.



10487
Verre
10,5 cm Ø x 10,5 cm
12
INOX.



10488
Plat à snacks
36,5 x 11,5 cm
12
INOX.



Tous les prix sont indiqués en P.V.P. unitaire.



Collection Galvanisée

Plats y seaux à texture petits cailloux. Pour servir repas et apéritifs.



GP8

Plat rond
21 x 21 x 3 cm

12

INOX.



GP10

Plat rond
26,5 x 26,5 x 3,5 cm

12

INOX.



GP12

Plat rond
32 x 32 x 3 cm

12

INOX.

GP96

Plat ovale
24 x 15 x 5 cm

12

INOX.



GP129

Plat ovale
31 x 22 x 5,5 cm

12

INOX.



Tous les articles en **gras** sont des produits de stock habituel. Consulter les couleurs disponibles.

■ Récipients pour apéritifs

Idéals pour présenter tous types d'apéritifs : frites, pop corns, légumes ou fruits aussi bien en plein air qu'en restaurant.



4-81870

Support pour rondelles d'oignons

6,3 cm Ø x 7 cm haut. - 156 gr

🍷 12

● INOX.



4-81873

Support pour rondelles d'oignons

8,9 cm Ø x 8,9 cm haut. - 340 gr

🍷 12

● INOX.



4-81872

Support pour rondelles d'oignons

8,9 cm Ø x 10,1 cm haut. - 340 gr

🍷 12

● INOX.



4-81874

Support pour rondelles d'oignons

11,4 cm Ø x 11,4 cm haut. - 623 gr

🍷 12

● INOX.



4-81878

Support pour rondelles d'oignons

17,8 cm Ø x 15,2 cm haut. - 1,3 kg

🍷 12

● INOX.



4-33778

Panier bucket

Recouvert de PVC noir
11,4 cm Ø x 10,1 cm haut.

🍷 24

● INOX.



4-33780

Panier bucket

Recouvert de PVC noir
13,7 cm Ø x 10,2 cm haut.

🍷 24

● INOX.



4-33782

Panier bucket

Recouvert de PVC noir
15,9 cm Ø x 10,8 cm haut.

🍷 24

● INOX.

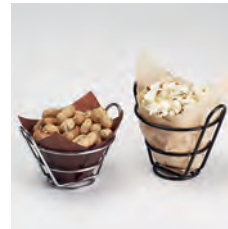

4-22770

Panier bucket

Chromé
11,4 cm Ø x 6,4 cm haut.

🍷 24

● INOX.



4-22778

Panier bucket

Chromé
11,4 cm Ø x 10,1 cm haut.

🍷 24

● INOX.



4-22780

Panier bucket

Chromé - 13,6 cm Ø x 10,2 cm haut.

🍷 24

● INOX.



4-22782

Panier bucket

Chromé - 15,9 cm Ø x 10,8 cm haut.

🍷 24

● INOX.



4-22787-S

Panier bucket

Chromé - 20,3 cm Ø x 20,3 cm haut.

🍷 24

● INOX.



4-22788-M

Panier bucket

Chromé - 25,4 cm Ø x 21,6 cm haut.

🍷 24

● INOX.



4-22789-L

Panier bucket

Chromé - 26,7 cm Ø x 25,4 cm haut.

🍷 24

● INOX.

Tous les prix sont indiqués en P.V.P. unitaire.

Récipients pour apéritifs (suite)

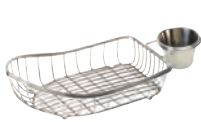

4-80117

Barque avec support à ramequin*

24,1 x 12,7 cm, support de 7 cm Ø



INOX.



4-80118

Barque avec support à ramequin*

27,3 x 15,9 cm, support de 7 cm Ø



INOX.



4-80007

Barque

24,1 x 12,7 cm



INOX.



4-80008

Barque

27,3 x 15,9 cm



INOX.

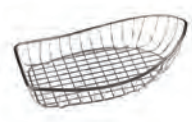

4-80300

Barque

33,7 x 19,7 cm



INOX.



4-81999*

Guitare avec orifice pour ramequin

49,5 x 29,2 cm



INOX.

*Ramequin non inclus



4-81929*

Guitare avec orifice pour ramequin

40,6 x 21,6 cm



INOX.

*Ramequin non inclus



4-882808*

Avion pour rondelles d'oignons avec supports à ramequin

30,5 x 28 cm support de 7 cm Ø*



INOX.

*Ramequins non inclus



4-92065-B*

Grande roue

36,8 cm Ø x 47 cm haut. capacité 5 mini paniers



INOX.

*Mini paniers non inclus

Supports à verres

4-82010*

Support à verres

Pour 10 verres, 29,8 x 8,3 cm



INOX.

*Verres non inclus



4-82018*

Support à verres

Pour 8 verres, 29,8 x 8,3 cm, hole de 5 cm



INOX.

*Verres non inclus



Rejoignez-nous



@DbmarkTweet



@dbmarkhosteleria



@dbmark_inst

Tous les articles en **gras** sont des produits de stock habituel. Consulter les couleurs disponibles.



■ Papier sulfurisé

Ils permettent d'emballer des aliments ou des préparations en toute sécurité. Revêtement entièrement adapté et apte au contact avec les aliments.

Disponible en petite, moyenne et grande taille.

La double ouverture permet de l'utiliser comme sac ou de l'insérer dans un cône d'apéritif.



4-T1000

Papier pour apéritif petit double ouverture

Blanc - 13,9 x 13,9 cm
pack 2.000 uds.



4-T1020

Papier pour apéritif petit double ouverture

Kraft - 13,9 x 13,9 cm
pack 2.000 uds.



4-T1050

Papier pour apéritif petit double ouverture

Journal - 13,9 x 13,9 cm
pack 2.000 uds.



4-T3020

Papier pour apéritif petit double ouverture

Journal - 13,9 x 13,9 cm
pack 2.000 uds.



4-T250

Papier pour apéritif moyen double ouverture

Blanc
17,8 x 17,8 cm
pack 250 uds.



4-T2000

Papier pour apéritif moyen double ouverture

Blanc
17,8 x 17,8 cm
pack 2.000 uds.



4-T3000

Papier pour apéritif moyen double ouverture

Journal
17,8 x 17,8 cm
pack 2.000 uds.



4-T3050

Papier pour apéritif moyen double ouverture

Journal
17,8 x 17,8 cm
pack 2.000 uds.



4-T4000

Papier pour apéritif moyen double ouverture

Kraft
17,8 x 17,8 cm
pack 2.000 uds.



4-T6000

Papier pour apéritif moyen double ouverture

Journal
17,8 x 17,8 cm
pack 2.000 uds.



Tous les prix sont indiqués en P.V.P. unitaire.

Papier sulfurisé (suite)



4-TS1010

Papier pour
apéritif grand

Blanc
30,5 x 30,5 cm
pack 1.000 uds.



4-TS4010

Papier pour
apéritif grand

Kraft
30,5 x 30,5 cm
pack 1.000 uds.



4-TF1600

Papier pour
apéritif grand

La Vue
30,5 x 30,5 cm
pack 1.000 uds.



4-TD1900

Papier pour
apéritif grand

Dubliner
30,5 x 30,5 cm
pack 1.000 uds.

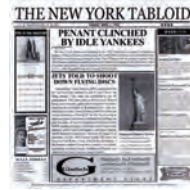

4-TY1200

Papier pour
apéritif grand

New York
30,5 x 30,5 cm
pack 1.000 uds.



4-TH1700

Papier pour
apéritif grand

Honolulu
30,5 x 30,5 cm
pack 1.000 uds.



4-TE1050

Papier pour
apéritif grand

La Habana
30,5 x 30,5 cm
pack 1.000 uds.



4-TN1000

Papier pour
apéritif grand

London
30,5 x 30,5 cm
pack 1.000 uds.



4-TN250

Papier pour
apéritif grand

London
30,5 x 30,5 cm
pack 250 uds.



4-TG1080

Papier pour
apéritif grand

Sports
30,5 x 30,5 cm
pack 1.000 uds.



4-TI1808

Papier pour
apéritif grand

La Gazzetta
30,5 x 30,5 cm
pack 1.000 uds.



4-TVariety

Papier pour
apéritif grand

Pack variété de
journal
30,5 x 30,5 cm
pack 1.000 uds.



4-TL1215

Papier pour apéritif grand

London
38,1 x 30,5 cm
pack 1.000 uds.



Tous les articles en **gras** sont des produits de stock habituel. Consulter les couleurs disponibles.



■ Miniaturas jetables

Éléments jetables parfaits pour servir des petites portions. En bois de pin écologique et biodégradable.



BAMDCN5

Mini cône

5 x 5,5 x 12,5 cm - 45 ml
- paq. 50 uds.

12



BAMDCN6

Mini cône

6,5 x 7 x 15 cm - 90 ml
- paq. 50 uds.

12



BAMDCN7

Mini cône

7,5 x 9 x 18 cm - 140 ml
- paq. 50 uds.

12

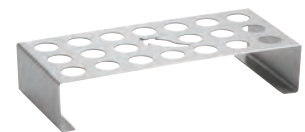

BBQ3500

Support mini cônes

Acier inoxydable
- 27,9 x 12,7 cm

1



BAMDB3

Petit bateau

8,5 x 5,5 x 2,5 cm - 30 ml - paq. 50 unités

12



BAMDB45

Petit bateau

11,5 x 6,5 x 3 cm - 45 ml - paq. 50 unités

12



BAMDB5

Petit bateau

13,5 x 8,5 x 4 cm - 90 ml - paq. 50 unités

12

BAMDCP2

Verrine

5 cm Ø x 5 cm - 60 ml - paq. 50 unités

12



BAMDCP1

Verrine

6,5 cm Ø x 6,5 cm - 120 ml - paq. 50 unités

12



Tous les prix sont indiqués en P.V.P. unitaire.

■ Bâtons de brochette en bambou

Utilisez les baguettes en bambou pour identifier les plats spéciaux, allergènes, sans gluten, etc.



BAMF35

Bâton à brochette style fourchette

9 cm - paquet de 100 unités

🛒 12



BAML35

Bâton à brochette style porte-cartes

9 cm - paquet de 100 unités

🛒 12



BAMK35

Bâton à brochette avec nœud

9 cm - paquet de 100 unités

🛒 12



BAMP35

Bâton à brochette épée

9 cm - paquet de 100 unités

🛒 12

BAML45

Bâton à brochette style porte-cartes

11,5 cm - paquet de 100 unités

🛒 12

BAMK45

Bâton à brochette avec nœud

11,5 cm - paquet de 100 unités

🛒 12

BAMP45

Bâton à brochette épée

11,5 cm - paquet de 100 unités

🛒 12

BAMK7

Bâton à brochette avec nœud

18 cm - paquet de 100 unités

🛒 12

BAMP7

Bâton à brochette épée

18 cm - paquet de 100 unités

🛒 12

Tous les articles en **gras** sont des produits de stock habituel. Consulter les couleurs disponibles.

■ Bâtons de brochette en bambou (suite)



WELLDONE

Bâton à brochette viande

"Bien cuit" - 9 cm - paquet de 100 unités

🛒 12



MEDWELL

Bâton à brochette viande

"Cuit" - 9 cm - paquet de 100 unités

🛒 12



MEDIUM

Bâton à brochette viande

"À point" - 9 cm - paquet de 100 unités

🛒 12



MEDRARE

Bâton à brochette viande

"Saignant" - 9 cm - paquet de 100 unités

🛒 12



RARE

Bâton à brochette viande

"Bleu" - 9 cm - paquet de 100 unités

🛒 12



BAMP35G

Bâton à brochette "sans gluten"

9 cm -paquet de 100 unités

🛒 12



BAMP5G

Bâton à brochette "sans gluten"

13 cm -paquet de 100 unités

🛒 12



BAMP45PR

Bâton à brochette " sans gluten" violet

11,5 cm -paquet de 100 unités

🛒 12

BAMP35A

Bâton à brochette "allergie"

9 cm
paquet de 100 unités

🛒 12



BAMP45A

Bâton à brochette "allergie"

11,5 cm
paquet de 100 unités

🛒 12



Tous les prix sont indiqués en P.V.P. unitaire.



■ Bâtons de brochette en bambou (suite)

BAMBA35

Cure-dents avec perle assortiment de couleurs

9 cm - paquet de 100 unités

🛒 12

BAMBA45

Cure-dents avec perle assortiment de couleurs

11,5 cm - paquet de 100 unités

🛒 12

906

Pics brochette bambou

15 cm - paquet de 1000 unités

🛒 1

908

Pics brochette bambou

20 cm - paquet de 1000 unités

🛒 1

910

Pics brochette bambou

25 cm - paquet de 1000 unités

🛒 1



BAMBCBP

Bâton à brochette avec ardoise

7,5 x 1,5 x 7,5 cm - avec pince paq. de 6 unités

🛒 12



BAMDCB35

Bâton à brochette avec ardoise

6,5 x 0,5 x 9 cm - paquet de 100 unités

🛒 12



Tous les articles en **gras** sont des produits de stock habituel. Consulter les couleurs disponibles.

■ Bâtons de brochette en bambou (suite)



BAMPS45

Bâton à brochette épée

11,5 cm
paquet de 50 uds.

🛒 12



BAMPS6

Bâton à brochette épée

15 cm
paquet de 50 uds.

🛒 12



BAML45

Bâton à brochette
boucle

11,5 cm - 1 boucle
paquet de 100 uds.

🛒 12



BAMH45

Bâton à brochette
boucle

11,5 cm - 2 boucles
paquet de 100 uds.

🛒 12



BAMH6

Bâton à brochette
boucle

15 cm - 2 boucles
paquet de 100 uds.

🛒 12



BAMSP145

Cure-dents sportif

Base-ball -
11,5 cm - paquet
de 100 unités

🛒 12



BAMSP245

Cure-dents sportif

Baloncesto -
11,5 cm - paquet
de 100 unités

🛒 12



BAMSP545

Cure-dents sportif

Football -
11,5 cm - paquet
de 100 unités

🛒 12



BAMSP645

Cure-dents sportif

Football américain -
11,5 cm - paquet
de 100 unités

🛒 12



BAMSP345

Cure-dents sportif

Tee de golf surtidos -
11,5 cm - paquet
de 100 unités

🛒 12

■ Pic à brochette en acier inoxydable



314

Pic à brochette en acier

35,5 cm - paquet de 60 unités

🛒 60

● INOX.



Rejoignez-nous



@DbmarkTweet



@dbmarkhosteleria



@dbmark_inst

Tous les prix sont indiqués en P.V.P. unitaire.

■ Bouteilles d'huile et salières en verre



600

Petite bouteille avec bouchon en acier inox
5 x 5 x 15 cm
180 ml

12



600N

Jeu de bouteilles huile et vinaigre
177 ml

6



9085

Bouteille pour huile d'auteur
5 x 5 x 26,5 cm
250 ml

12



916

Bouteille pour huile d'auteur
5,5 x 5,5 x 31 cm
470 ml

12



599P

Bec verseur
Acier inoxydable

12

Les bouteilles 9085 et 916 incluent le bec verseur 599P.



30S&P

Salière et poivrière
Cubique, couvercle chromé
3 x 3 x 5 cm - 15 ml

24



83S&P

Salière et poivrière
Eiffel en verre, couvercle chromé
5 x 5 x 11 cm - 30 ml

24



150S&P-2

Salière et poivrière
Polygonales en verre, couvercle en acier inox.
4 x 4 x 7,5 cm - 30 ml

24



154S&P-2

Salière et poivrière
Carrées en verre, couvercle en acier inox.
4 x 4 x 10 cm - 60 ml

24



155S&P-2

Salière et poivrière
Polygonales, couvercle en acier inox.
4 x 4 x 10 cm - 60 ml

24



H15S&P

Salière et poivrière avec couvercle en clip
7 x 4,5 x 6,5 - 45 ml

6



H2S&P

Salière et poivrière avec couvercle en clip
7 x 4,5 x 8,5 - 60 ml

6



H475S&P

Salière et poivrière Mason Jar
7,5 x 5,5 x 8,5 cm - 140 ml

6

Tous les articles en **gras** sont des produits de stock habituel. Consulter les couleurs disponibles.

Boles et vases



SRB5CW

Bol
Policarbonato - 148 ml

24

○ 135 ○ 148 ● 110



SRB13CW

Bol
Policarbonato - 384 ml

24

○ 135 ○ 148 ● 110



SRB5

Bol
SAN - 148 ml

24

○ 135 ○ 148 ● 110



SRB13

Bol
SAN - 384 ml

24

○ 135 ○ 148 ● 110



BV6CW

Vase en polycarbonate
15,24 cm

12

○ 135 ○ 148 ● 110



CBV2552

Vase en ardoise
Rond - 6,5 cm Ø x 13,5 cm

24

●



CBV6218

Vase en ardoise
Carré - 5 x 5 x 16 cm

24

●



DSPR6

Seau à boisson
Distributeur de boissons - 21 L

1

○ 148



PWB22

Seau multifonction
Seau gradué - 20 L

6

○ 148



RFSC12

Couvercle pour seau multifonction
Couvercle pour PWB22

6

○ 148

Tous les prix sont indiqués en P.V.P. unitaire.

Porte-cartes et numéros

Identifiez les tables d'un banquet ou autre célébration avec un numéro ou personnalisez vos cartes et menus.



CH2

Pince en acier inoxydable
Circular - 5 x 5 x 9 cm

12



CHX4

Pince en acier inoxydable
Doble - 11,5 x 1 x 1,5 cm

12



CHX8

Pince en acier inoxydable
Doble - 21,5 x 1 x 0,5 cm

12



CH5

Pince en acrylique
2,5 x 2,5 x 11 cm

12



RCH21

Support
5 x 3 x 1,5 cm

12



596

Porte-carte nickelé
5,5 x 5,5 x 5 cm

24



4CHS

Pince en plastique
Carré - argenté
2,5 x 2,5 x 11 cm

12



4CHSBK

Pince en plastique
Carré - noir
2,5 x 2,5 x 11 cm

12



5CHBAM

Porte-carte, support
en bambou
Pince en métal
2,5 x 2,5 x 14 cm

12



5CHBAMCP

Porte-carte, support
en bambou
Pince à linge
2,5 x 2,5 x 14 cm

12



BFCH4

Porte-carte fourchette
en acier inoxydable
5 x 4 x 10 cm

12



SGN-25

Porte-carte en métal noir
guitare
11,4 cm

1

Tous les articles en **gras** sont des produits de stock habituel. Consulter les couleurs disponibles.

Porte-cartes et numéros (suite)

SGN-01

Porte-carte en métal noir Eiffel

20,3 cm



SGN-24

Porte-carte chromée fleur de lys

6,3 cm



SGN-14

Porte-carte chromée avec plaque en céramique

16,5 cm



SGN-15

Porte-carte chromée avec plaque en céramique

21,5 cm



797

Porte-carte harpe en acier inoxydable

2 x 2 x 4 cm



INOX.



2504

Porte-carte harpe en acier inoxydable

5,5 x 5,5 x 10 cm



INOX.



2508

Porte-carte harpe en acier inoxydable

6,5 x 6,5 x 19,5 cm



INOX.



2512

Porte-carte harpe en acier inoxydable

7,5 x 7,5 x 30,5 cm



INOX.

INOX

Rejoignez-nous



@DbmarkTweet



@dbmarkhosteleria



@dbmark_inst

Tous les prix sont indiqués en P.V.P. unitaire.

Porte-cartes et numéros (suite)



1306

Porte-carte de acier inoxydable

15 cm

🗑️ 6



BKB8

Porte-carte branche en métal chromé

6,5 x 6,5 x 20,5 cm - Noir

🗑️ 12



BKB12

Porte-carte branche en métal chromé

7 x 7 x 30,5 cm - Noir

🗑️ 12

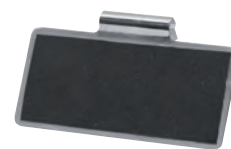

CBTSS3

Étiquette en acier inoxydable avec ardoise

7,5 x 1,5 x 4,5 cm

6 unités par paquet

🗑️ 12



1908

Porte-carte fond plat en métal chromé

5,5 x 5,5 x 20,5 cm

🗑️ 20



1912

Porte-carte fond plat en métal chromé

5,5 x 5,5 x 30,5 cm

🗑️ 20



BK1908

Porte-carte fond plat en métal chromé

5,5 x 5,5 x 20,5 cm
Noir

🗑️ 20



BK1912

Porte-carte fond plat en métal chromé

6,5 x 6,5 x 30,5 cm
Noir

🗑️ 20



BK1915

Porte-carte fond plat en métal chromé

7 x 7 x 38,5 cm
Noir

🗑️ 20

Poubelles de table

Avec un design très moderne, ces petites poubelles de tables sont parfaites pour les petits volumes de déchets apportant ordre et propreté.



WM1

Mini poubelle en acier inoxydable

12 x 12 x 17,7 cm

🗑️ 12

● INOX.



SSTB-11

Mini poubelle en acier inoxydable

17,1 x 27,9 cm

🗑️ 1

● INOX.



SSTB-6

Mini poubelle en acier inoxydable

12 x 19 cm

🗑️ 12

● INOX.

INOX

Tous les articles en **gras** sont des produits de stock habituel. Consulter les couleurs disponibles.

Récepteur pour sachets de sucre



SC-66

Récepteur rectangulaire en SAN
8,9 x 6,4 cm

24

W CL BK BR FG
PB RO TY IR



56B

Récepteur rectangulaire en plastique
8,5 x 6,5 x 5 cm - noir

24

BK



56C

Récepteur rectangulaire
en plastique
8,5 x 6,5 x 5 cm
transparent

24

CL



56W

Récepteur rectangulaire
en plastique
8,5 x 6,5 x 5 cm
blanc

24

W



BK256

Récepteur métal poudre
noire

rectangulaire
8 x 6,5 x 5 cm

12

BK



BK155

Récepteur métal poudre
noire

cylindrique
5 x 5 x 6,5 cm

12

BK



1156

Récepteur en acier inoxydable
rectangulaire

5 x 5 x 6,5 cm

12

INOX.



1157

Récepteur en acier inoxydable
rectangulaire

8 x 6,5 x 4,5 cm

12

INOX.



1155

Récepteur en acier inoxydable cylindrique

5 x 5 x 7 cm

12

INOX.

Tous les prix sont indiqués en P.V.P. unitaire.



Chaises hautes



63EU

Chaise haute en bois
50 x 50 x 73,5 cm - blanc



65EU

Chaise haute en bois
50 x 50 x 73,5 cm - bois naturel



66EU

Chaise haute en bois
50 x 50 x 73,5 cm - noyer



Les espaces au niveau des panneaux latéraux entre les accoudoirs et l'assise ont été réduits pour éviter que les membres des enfants ne s'y coincent.

Utilisation de rondelles de séparation pour toutes les vis pour éviter les desserrages.

Ajout d'une fixation permanente à l'avant et augmentation de la taille du dossier afin de maintenir l'enfant en toute sécurité sur sa chaise.



Stabilité accrue et barres de soutiens renforcées pour éviter les risques de chute.

Tous les articles en **gras** sont des produits de stock habituel. Consulter les couleurs disponibles.















A Lorsque vous devez choisir un plateau pour du libre-service, vous devez prendre en compte les éléments suivants :

- La taille : la taille de la table sur laquelle seront posés les plateaux mais aussi celle des plateaux que vous souhaitez pour votre entreprise (menu, carte), sans oublier de prendre en considération la taille de vos chariots à plateaux.
- Le budget : votre budget ainsi que la corrélation entre la valeur du menu et la qualité du plateau.
- La qualité et les propriétés techniques : résistance mécanique, chimique, fréquence de lavage, etc.

Vous trouverez dans les pages suivantes le plus grand choix de plateaux au monde. Nous sommes à votre disposition pour vous aider à choisir celui qui correspond le mieux à vos besoins.







■ Guide de plateaux

	PLATEAUX EN POLYESTER		PLATEAUX EN FIBRE DE VERRE				
	SMC Économique	SMC haute performance.	Camtray	Régime	Camlite	Camtread	EpicTread
							
Matériau	SMC - polyester renforcé avec de la fibre de verre	SMC - polyester renforcé avec de la fibre de verre	Fibre de verre + résine en polyester	Fibre de verre + résine en polyester	Fibre de verre + résine en polyester	Fibre de verre + résine en polyester + surface caoutchoutée antidérapante	Fibre de verre + antidérapante, surface déperlante
Surface	Lisse	Lisse	Lisse	Lisse	Lisse	Antidérapante caoutchoutée	Antidérapante
Personnalisation	Oui	Oui	Oui	Non	Non	Oui	Oui Résistance thermique 90 °C
Années de garantie	3	5	5	1	3	5	2
Lave-vaisselle	Oui Fréq. normale	Oui Fréquemment	Oui Fréquemment	Oui Fréquemment	Oui Fréquemment	Oui Fréquemment	Oui Occasionnellement
Résistance thermique	-40 °C à 130 °C	-40 °C à 140 °C	-10 °C à 100 °C	-10 °C à 100 °C	-10 °C à 100 °C	-10 °C à 100 °C	-10 °C à 90 °C

	PLATEAUX STRATIFIÉS				POLIÉSTER	CAMWEAR
	Corfú	Mykonos	Capri	Madeira	Century	Camwear
						
Matériau	Stratifié, surface antidérapante caoutchoutée	Stratifié, surface antidérapante	Stratifié	Stratifié	Polyester, coins renforcés	Camwear
Surface	Antidérapante	Antidérapante	Lisa	Texturée	Texturée	Texturée
Personnalisation	Oui	Oui	Oui	Non	Oui	Non
Années de garantie	3	3	3	3	5	3
Lave-vaisselle	Oui Fréq. normale	Oui Occasionnellement	Oui Fréq. normale	Oui Fréq. normale	Oui Fréq. normale	Oui Fréquemment
Résistance thermique	-10 °C à 100 °C	- 10 °C à 100 °C	-10 °C à 100 °C	-10 °C à 100 °C	-40 °C à 90 °C	-40 °C à +99 °C

Tous les prix sont indiqués en P.V.P. unitaire.

■ Guide de plateaux (suite)

	PLATEAUX BOIS		PLATEAUX POLYPROPYLENE		PLATEAUX COMPARTIMENTÉS		PLATEAUX DE PRÉSENTATION
	À surface lisse	À surface antidérapante	Polytread	Fast Food			
							
Matériau	Hêtre contreplaqué	Hêtre contreplaqué / acajou + surface antidérapante	Polypropylène + surface caoutchoutée antidérapante	Polypropylène	Polycarbonate	Copolymère	Couches en fibre de verre + résine polyester
Surface	Lisse	Antidérapante	Antidérapante de caoucho	Texturée	Texturée	Texturée	Lisse
Personnalisation	Non	Oui	Non	Oui Résistance thermique : 80 °C	Non	Non	Non
Années de garantie	3	3	1	3	2	2	3
Lave-vaisselle	Oui Fréq. normale	Oui Occasionnellement	Oui Occasionnellement	Oui Occasionnellement	Oui Fréquemment	Oui Occasionnellement	Oui Fréquemment
Résistance thermique	-10 °C à 100 °C	-10 °C à 100 °C	-10 °C à 80 °C	-10 °C à 80 °C	-40 °C à 149 °C	-10 °C à 80 °C	-10 °C à 100 °C

Choisissez le plateau qui vous convient

1

À quel usage le plateau va-t-il servir ?

Vous devez d'abord identifier l'utilisation que vous allez en faire.

Plateau antidérapant : utilisé par clients et employés pour porter divers articles.

Plateau à surface lisse : utilisé par les employés pour porter les articles aux clients.

2

Avec quelle fréquence allez-vous utiliser et laver le plateau ?

Déterminez comment sera utilisé le plateau et quelle sera sa fréquence de lavage.

Utilisation réduite : un lavage par jour.

Utilisation normale : jusqu'à 3 lavages par jour.

Utilisation intensive : Lavage aussi fréquent que nécessaire.

3

Budget

Le prix du plateau varie en fonction de :

- Processus de fabrication
- Type de matériaux
- Taille
- Personnalisation
- Garantie

4

Personnalisation

Nous offrons une personnalisation de qualité sur la plupart des plateaux.

Cherchez le logo 

5

Caractéristiques supplémentaires à considérer

Évaluez l'importance des caractéristiques suivantes pour votre activité :

- Plots d'empilage
- Résistance de la surface aux impacts
- Résistance aux rayures et aux tâches
- Type de garantie

Tous les articles en **gras** sont des produits de stock habituel. Consulter les couleurs disponibles.

Plateaux en SMC (polyester renforcé en fibre de verre) économiques, couleurs disponibles limitées. Grande résistance et performance.



Plateau Versa Lite - rebord élevé

Code	Description	UE
VL1014	27 x 35 cm	12
VL1216	30,5 x 41,5 cm	12
VL1418	35,5 x 45,7 cm	12
VL3343	33 x 43 cm	12



Plateau Versa Lite - rebord bas

Code	Description	UE
VL2632	32,5 x 26,5 cm	12
VL3253	32,5 x 53 cm	12
VL3753	37 x 53 cm	12



Plateau Versa Century - Rebord élevé -Forme profilée

Code	Description	UE
VL3343C	32,9 x 42,9 cm	12
VL3646C	35,5 x 45,7 cm	12

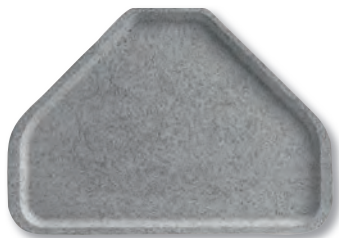

Plateau Versa Space Saver

Code	Description	UE
GL4210	48 x 34 cm	12



Plateau Versa Lite - Rebord plat

Code	Description	UE
GL0540	46 x 34,4 cm	12
GL1070	32,5 x 26,5 cm	12
GL1080	37 x 26,5 cm	12
GL3074	45 x 32 cm	12
GL3980	37 x 53 cm	12
GL4002	32,5 x 53 cm	12
GL4060	40 x 60 cm	12
GL4701	42,5 x 32,5 cm	12

Couleurs disponibles

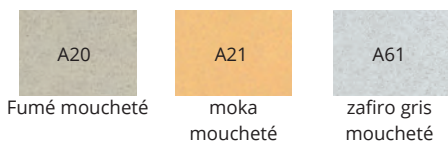

Couleurs sur commande

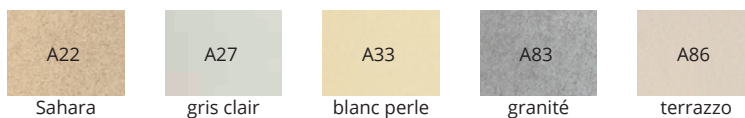

Tous les prix sont indiqués en P.V.P. unitaire.

Plateaux de SMC (polyester renforcé en fibre de verre). Excellentes performance et résistance. Compatibles avec des lavages fréquents.



Plateau Versa Tray - Rebord élevé

Code	Description	UE
VT1216	30,5 x 41,5 cm	12
VT1418	35,5 x 45,7 cm	12
VT3343	33 x 43 cm	12



Plateau Versa Tray - Rebord bas

Code	Description	UE
VT2632	32,5 x 26,5 cm	12
VT3253	32,5 x 53 cm	12
VT3753	37 x 53 cm	12
VT3853	37,5 x 5,23 cm	12



Plateau Versa Century - Forme profilée

Code	Description	UE
VT3343C	33 x 43 cm	12
VT3646C	36 x 46 cm	12



Plateau Versa Tray - Rebord plat

Code	Description	UE
GP0540	46 x 34,4 cm	12
GP1070	32,5 x 26,5 cm	12
GP1080	37 x 26,5 cm	12
GP3074	45 x 32 cm	12
GP3980	37 x 53 cm	12
GP4002	32,5 x 53 cm	12
GP4004	32,5 x 53 cm - texturée	12
GP4701	42,5 x 32,5 cm	12
GP4709	46 x 32,5 cm	12
GP4856	34,5 x 23 cm	12



Couleurs plateau Versa

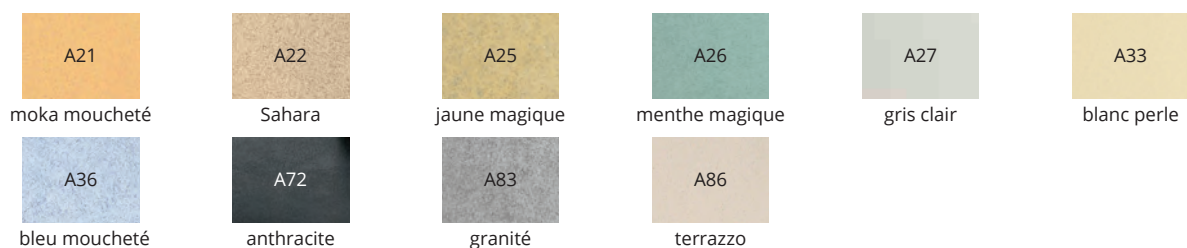

Tous les articles en **gras** sont des produits de stock habituel. Consulter les couleurs disponibles.

■ Plateaux Camtray

Surface lisse

CAMBRO a inventé, il y a plus de 55 ans le plateau Camtray, l'authentique plateau en fibre de verre qui bénéficie d'une garantie de 5 ans. Sans aucun doute, le meilleur plateau du marché. Personnalisable.



Plateau rectangulaire - Rebord élevé

Code	Description	UE
915	22 x 38 cm	12
926	22,5 x 65 cm	12
1014	27 x 35 cm	12
1015	26 x 38 cm	24
1116	27,5 x 40,5 cm	24
1216	30,5 x 41,5 cm	12
3242	31,9 x 41,9 cm	12
1313	33 x 33 cm	12
1318	32 x 45 cm	12
1418	35,5 x 45,7 cm	12
3853	37,5 x 53 cm	12
1520	38 x 51,5 cm	12
1622	40,5 x 56 cm	12
16225	42 x 57 cm	12
1826	45,5 x 65,5 cm	6



Plateau rectangulaire - rebord bas

Code	Description	UE
46	11 x 15 cm	12
57	12,5 x 18 cm	12
810	20,5 x 25 cm	12
2632	26,5 x 32,5 cm	12
3046	30 x 46 cm	12
3253	32,5 x 53 cm	12
3343	33 x 43 cm	12
3753	37 x 53 cm	12
2025	53 x 65 cm	6



Plateau rond - rebord élevé

Code	Description	UE
900	23 cm Ø	12
1000	25,5 cm Ø	12
1100	28 cm Ø	12
1200	30,5 cm Ø	12
1300	33 cm Ø	12
1400	35,5 cm Ø	12
1600	40,5 cm Ø	12

Tous les prix sont indiqués en P.V.P. unitaire.



Plateau rond et ovale- rebord bas

Code	Description	UE
1550	40,5 cm Ø	12
1950	49,5 cm Ø	12
2500	49 x 61 cm	6
2700	56 x 68,5 cm	6



Plateau trapézoïdal

Code	Description	UE
1418TR	35,5 x 45,7 cm	12
1422TR	35,5 x 56 cm	12
1520TR	37 x 49,5 cm	12

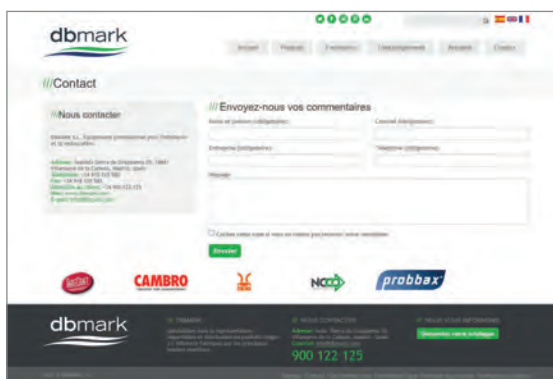

N'hésitez pas à nous consulter.

Dans la section de contact de notre site vous pourrez trouver nos informations de contact (adresse, téléphone, e-mail, etc.).

Vous pouvez également nous poser vos questions ou commentaires.

www.dbmark.com

Tous les articles en **gras** sont des produits de stock habituel. Consulter les couleurs disponibles.

Couleurs Groupe I disponibles

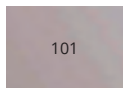

101
parchemin antique

Couleurs Grupo I bajo pedido

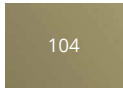

104
brun désert

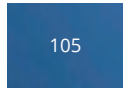

105
bleu horizon

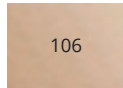

106
pêche claire

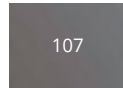

107
gris perle

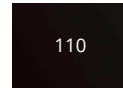

110
noir

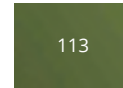

113
citron vert

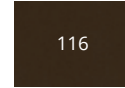

116
brun Brésil

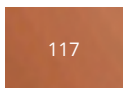

117
pêche foncée



119
vert Sherwood



123
bleu Amazone

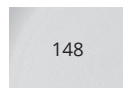

148
blanc

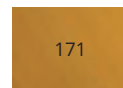

171
or Toscane

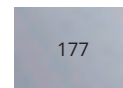

177
bleu ciel

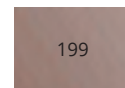

199
taupe

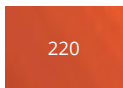

220
citron-orange

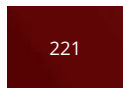

221
rouge éternel

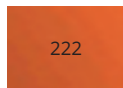

222
orange vif

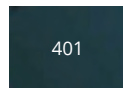

401
bleu ardoise

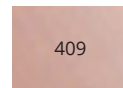

409
vieux rose

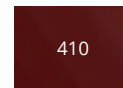

410
framboise

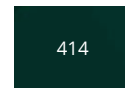

414
vert turquoise

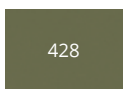

428
vert olive

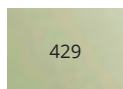

429
vert jaune

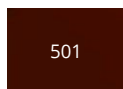

501
rouille

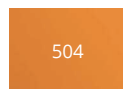

504
moutarde

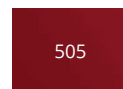

505
rouge cerise

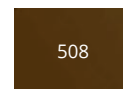

508
brun cuir

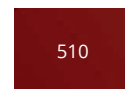

510
rouge vif

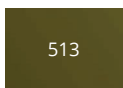

513
brun laurier

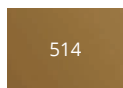

514
terre dorée

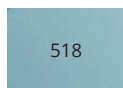

518
bleu clair

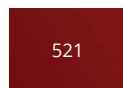

521
rouge Cambro

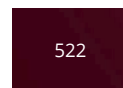

522
bordeaux

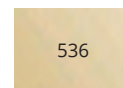

536
citron meringue

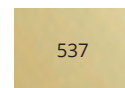

537
jaune caméo

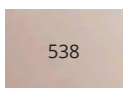

538
blanc cottage

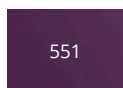

551
raisin

Motifs Groupe I sur commande



214
bronceado

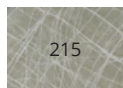

215
gris abstrait



241
doily parchemin
antique

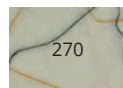

270
nervures swirl noir

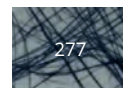

277
nervuré gris

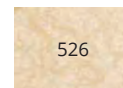

526
galaxy parchemin
antique

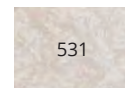

531
galaxy parchemin
antique argent

Groupe III Bois sur commande

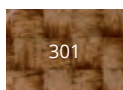

301
vannerie foncée

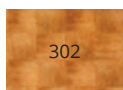

302
vannerie claire

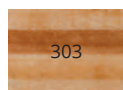

303
planche à
découper claire



304
chêne

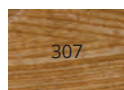

307
orme clair



308
teck de Birmanie



309
teck de Java

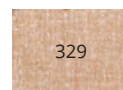

329
caramel

Tous les prix sont indiqués en P.V.P. unitaire.



Nouveauté

■ Plateaux Camtray Gamme Décor

Les Camtrays de la gamme Décor sont fabriqués avec le tact du bois authentique. Parfaite pour les restaurants qui veulent présenter à la fois un aspect moderne et rustique et bénéficier de longue durabilité du classique Camtray.

Camtrays Gamme Décor avec surface texturée



1216DC

Plateaux à surface texturée

30,5 x 41,5 cm

👉 12



1418DC

Plateaux à surface texturée

35,5 x 45,7 cm

👉 12



1520DC

Plateaux à surface texturée

38 x 51,5 cm

👉 12



Gris Pierre (810)



Gris Anthracite (815)



Olivier Clair (820)



Chêne Foncé (825)



Chêne Clair (830)

Camtrays Gamme Décor avec surface antidérapante EpicTread



1216DCET

Plateaux à surface antidérapante

30,5 x 41,5 cm

👉 12



1418DCET

Plateaux à surface antidérapante

35,5 x 45,7 cm

👉 12



1520DCET

Plateaux à surface antidérapante

38 x 51,5 cm

👉 12

Tous les articles en **gras** sont des produits de stock habituel. Consulter les couleurs disponibles.

■ Plateaux Régime

Usage spécifique

Plateaux en fibre de verre, coins prononcés et rebord plat augmentant ainsi la surface disponible du plateau.

Plateau régime - rebord bas

Code	Description	UE
1216D	30,5 x 41,5 cm	12
1219D	30,5 x 48,3 cm	12
1220D	30,5 x 51 cm	12
1222D	30,5 x 56 cm	12
1418D	35,5 x 46 cm	12
1520D	38 x 51,3 cm	12



■ Plateaux Camlite

Usage spécifique

Plateaux en fibre de verre. Très bonne performance et résistance.

Plateau rectangulaire - rebord élevé

Code	Description	UE
1014CL	27 x 35 cm	12
1216CL	30,5 x 41,5 cm	12
1418CL	36 x 46 cm	12
1520CL	38 x 51,5 cm	12
1826CL	45,5 x 65,5 cm	12

Plateau rectangulaire - rebord bas

Code	Description	UE
3253CL	32,5 x 53 cm	12



Couleurs plateau Camlite

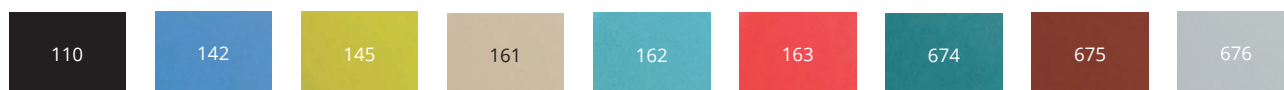

Tous les prix sont indiqués en P.V.P. unitaire.



■ Plateaux Camtread

Surface antidérapante

CAMBRO offre la plus grande gamme de plateaux antidérapants au monde, combinant différentes qualités de plateaux et de surfaces antidérapantes. Les plateaux antidérapants sont particulièrement adaptés pour les serveurs et le service à table.

Plateau rond - rebord élevé

Code	Description	Couleurs		UE
		Disponibles	Sur commande	
900CT	23 cm Ø		110 ■ 138 ■	12
1100CT	28 cm Ø		110 ■ 138 ■	12
1400CT	35,5 cm Ø		110 ■ 138 ■	12
1600CT	40,5 cm Ø	138 ■	110 ■	12
1600TL	40,5 cm Ø	138 ■		12
1800CT	45 cm Ø	138 ■	110 ■	6



Plateau rond - rebord bas

Code	Description	Couleurs	UE
1550CT	40,5 cm Ø	110 ■ 138 ■	12
1950CT	49,5 cm Ø	110 ■ 138 ■	12



Plateau rectangulaire - rebord élevé

Code	Description	Couleurs		UE
		Disponibles	Sur commande	
1014CT	27 x 35 cm		110 ■ 138 ■	12
1216CT	30,5 x 41,5 cm		110 ■ 138 ■	12
1418CT	36 x 46 cm		110 ■ 138 ■	12
1520CT	38 x 51,5 cm		110 ■ 138 ■	12
1622CT	40,5 x 56 cm	138 ■	110 ■	12
1826CT	45 x 65 cm	138 ■	110 ■	6

Tous les articles en **gras** sont des produits de stock habituel. Consulter les couleurs disponibles.

■ Plateaux Camtread (suite)

Plateau rectangulaire - rebord bas

Code	Description	Couleurs	UE
3253CT	32,5 x 53 cm	110 ■ 138 ■	12

Plateau ovale- rebord bas

Code	Description	Couleurs		UE
		Disponibles	Sur commande	
2500CT	49 x 59 cm	138 ■	110 ■	6
2700CT	56 x 68,5 cm	138 ■	110 ■	6
2900CT	73,5 x 60 cm	138 ■	110 ■	6

Surface antidérapante



■ Supports ciseaux



Support ciseaux en bois

Code	Description	UE
21	81 cm	1
22	96,5 cm	1

Support ciseaux chromé

Code	Description	UE
23	74 cm	1
24	79 cm	1

Support ciseaux chromé noir

Code	Description	UE
23BK	74 cm	1
24BK	79 cm	1

Rejoignez-nous



@DbmarkTweet



@dbmarkhosteleria



@dbmark_inst

Tous les prix sont indiqués en P.V.P. unitaire.

Plateaux de Room Service

Plateaux en bois, en polyéthylène simulant le bois ou bien en ABS. Leurs poignées en font des plateaux parfaits pour le service d'habitation aussi bien dans les hôtels comme en maisons de retraite.



Plateau en bois écologique

Code	Description	Couleurs	UE
RST-1814-	35,6 x 45,7 cm	M ■ N ■	6
RST-2516-	63,5 x 40,6 cm	M ■ N ■	6
RST-2020-M	53 x 53 cm	M ■	2
LUX-1816-M	36,2 x 48,3 cm	M ■	6
LUX-2121-M	53 x 53 cm	M ■	2
LUX-2518-M	63,5 x 40,6 cm	M ■	6

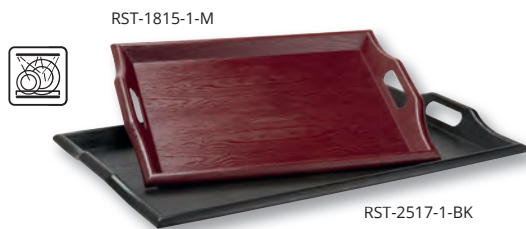

Plateau en polyéthylène

Code	Description	Couleurs	UE
RST-1815-1-	48,3 x 36,2 cm	M ■ BK ■	6
RST-2517-1-	63,5 x 40,6 cm	M ■ BK ■	6



Plateau en ABS

Code	Description	Couleurs	UE
RST-1522-	38 x 50,8 cm	BK ■	6
RST-1523-	38,7 x 54 cm	BK ■	12



Tous les articles en **gras** sont des produits de stock habituel. Consulter les couleurs disponibles.



■ Plateaux imitation fonte

Ces plateaux sont parfaits pour servir et présenter des entrées, garnitures, boissons, desserts et plus encore ! Aspect mat et texture imitation fonte.



10047

Plateau imitation fonte
31 x 20,5 x 3 cm



10048

Plateau imitation fonte
51 x 33,6 x 4 cm



■ Plateaux Polytread



Plateau rond

Code	Description	Couleurs	UE
PT1100	28 x 28 cm	110 ■ 167 ■	12
PT1400	35,5 x 35,5 cm	110 ■ 167 ■	12
PT1600	40,5 x 40,5 cm	110 ■ 167 ■	12



Plateau rectangulaire

Code	Description	Couleurs	UE
PT1014	27 x 34,5 cm	110 ■ 167 ■	24
PT1216	30 x 41,5 cm	110 ■ 167 ■	24
PT1418	36 x 46 cm	110 ■ 167 ■	12

Tous les prix sont indiqués en P.V.P. unitaire.

Plateaux Epictread

Surface antidérapante

Plateaux en fibre de verre à surface antidérapante et imperméable. Style, performance et durabilité en un seul plateau.

Plateau rond

Code	Description	Couleurs	UE
1400ET	38,9 cm Ø	110 ■ 206 ■ 207 ■ 503 ■	12
1600ET	43,7 cm Ø	110 ■ 206 ■ 207 ■ 503 ■	12



FIBRE DE VERRE
Surface antidérapante
et imperméable

PERSONNALISABLE
Des deux côtés



POIGNÉES PLATES
Pour faciliter
la manipulation

VARIÉTÉ DE COULEURS
De la plus traditionnelle
à la plus moderne



Rouge 521

Vert 206

Bordeaux 207

Bleu 503

Noir 110



Plateau rectangulaire

Code	Description	Couleurs	UE
1014ET	27 x 35 cm	110 ■ 206 ■ 207 ■ 503 ■	12
1216ET	30,5 x 41,5 cm	110 ■ 206 ■ 207 ■ 503 ■	12
1418ET	35,5 x 45,7 cm	110 ■ 206 ■ 207 ■ 503 ■	12
1520ET	38 x 51,5 cm	110 ■ 206 ■ 207 ■ 503 ■	12

Tous les articles en **gras** sont des produits de stock habituel. Consulter les couleurs disponibles.

■ Plateaux en bois extra

Surface lisse

Plateaux en hêtre. Style et élégance pour les plus classiques.



Plateau rectangulaire

Code	Description	Couleurs		UE
PH556510	27 x 20 cm	Hêtre	■	12
PH556520	33 x 23 cm	Hêtre	■	12
PH556010	45 x 32 cm	Hêtre	■	12
PH556020	58 x 38 cm	Hêtre	■	12
PH556030	63 x 40 cm	Hêtre	■	12
PH556040	70 x 45 cm	Hêtre	■	12
PH556050	75 x 48 cm	Hêtre	■	12



Plateau rond

Code	Description	Couleurs		UE
PH558510	32 cm Ø	Hêtre	■	12
PH558520	36 cm Ø	Hêtre	■	12
PH558530	42 cm Ø	Hêtre	■	12



Plateau ovale

Code	Description	Couleurs		UE
PH557010	23 x 16 cm	Hêtre	■	12
PH557020	26 x 20 cm	Hêtre	■	12
PH557030	29 x 21 cm	Hêtre	■	12
PH557040	33 x 24 cm	Hêtre	■	12



Vous voulez être au courant?
Venez sur notre site Web
et vous serez tenus informés de nos nouveautés,
nouvelles, promotion, etc.

www.dbmark.com

Tous les prix sont indiqués en P.V.P. unitaire.

■ Plateaux en bois extra

Plateaux en hêtre et acajou. Style et élégance pour les plus classiques.

Surface antidérapante



Plateau rectangulaire en bois de hêtre

Code	Description	UE
PH556016	45 x 32 cm	12
PH556026	58 x 38 cm	12
PH556036	63 x 40 cm	12
PH556046	70 x 45 cm	12
PH556056	75 x 48 cm	12
PH556516	27 x 20 cm	12
PH556526	33 x 23 cm	12

Plateau ovale en bois de hêtre

Code	Description	UE
PH557016	23 x 16 cm	24
PH557026	26 x 20 cm	24
PH557036	29 x 21 cm	24
PH557046	33 x 24 cm	24

Plateau rond en bois de hêtre

Code	Description	UE
PH558516	32 cm Ø	12
PH558526	36 cm Ø	12
PH558536	42 cm Ø	12

Plateau rectangulaire en bois d'acajou

Code	Description	UE
MW3245	32 x 45 cm	12
MW3646	36 x 46 cm	12
MW3858	37,5 x 57,5 cm	12

Plateau ovale en bois d'acajou

Code	Description	UE
MW2129	21 x 29 cm	12

Plateau rond en bois d'acajou

Code	Description	UE
MW3200	32 cm Ø	12
MW3600	36 cm Ø	12
MW4200	42 cm Ø	12

Tous les articles en **gras** sont des produits de stock habituel. Consulter les couleurs disponibles.

■ Plateaux Century surface lisse

La veine du bois texturée couvre les deux côtés de la surface donnant cette apparence et sensation de bois véritable. Le plateau Century est disponible en cinq textures à combiner avec tous les styles de décoration. Fabriqués en polyester haute performance, ils sont parfaits pour une utilisation intense, résistants aux rayures, taches et cassures. Résiste à des températures de -40 °C à 90 °C.



Plateau imitation bois

Code	Description	UE
VTC3343T	33 x 43 cm	12
VTC3646T	35,5 x 45,7 cm	12
VTC3253T	32,5 x 53 cm	12
VTC3753T	37 x 53 cm	12



Chêne clair (F86)



Chêne brun (F87)



Chêne foncé (F88)



Olivier clair (F89)



Marron olivier (F90)



Chêne gris (F91)



Tous les prix sont indiqués en P.V.P. unitaire.

■ Plateaux Century surface antidérapante

Surface antidérapante qui maintient nourritures et boissons à leur place, assurant stabilité lors de son utilisation.



VTC3343TNS

Plateau imitation bois

33 x 43 cm

🗑️ 12

VTC3646TNS

Plateau imitation bois

35,5 x 45,7 cm

🗑️ 12

VTC3253TNS

Plateau imitation bois

32,5 x 53 cm

🗑️ 12

VTC3753TNS

Plateau imitation bois

37 x 53 cm

🗑️ 12



Chêne clair (F86)



Chêne brun (F87)



Chêne foncé (F88)



Olivier clair (F89)



Marron olivier (F90)

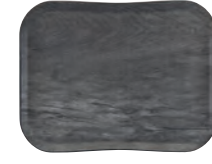

Chêne gris (F91)

■ Plateaux Century surface texturée antidérapante caoutchouc



VTCT3343T

Plateau texturé antidérapant

33 x 43 cm

🗑️ 12



VTCT3646T

Plateau texturé antidérapant

35,5 x 45,7 cm

🗑️ 12



VTCT3253T

Plateau texturé antidérapant

32,5 x 53 cm

🗑️ 12



VTCT3753T

Plateau texturé antidérapant

37 x 53 cm

🗑️ 12



Tous les articles en **gras** sont des produits de stock habituel. Consulter les couleurs disponibles.

Les plateaux stratifiés de CAMBRO sont compatibles avec des lavages fréquents et s'adaptent à tout type de budget.

Plateau rectangulaire - rebord élevé

Code	Description	UE
CA2028	20 x 28 cm	24
CA2632	26,5 x 32,5 cm	24
CA2738	27 x 38 cm	24
CA2836	28 x 36 cm	24
CA3244	32 x 44 cm	24
CA3253	32,5 x 53 cm	24
CA3343	33 x 43 cm	24
CA3446	34 x 46 cm	24
CA3646	36 x 46 cm	24
CA3748	37 x 48 cm	24
CA3753	37 x 53 cm	24
CA3952	39 x 52 cm	24
CA4064H	À poignées - 39,2 x 63,5 x 3 cm	12
CA4361	43 x 61 cm	12



Plateau rond

Code	Description	UE
CA1300	13 cm Ø	24
CA1300-E01	13 cm Ø - MERCI	24
CA3200	32 cm Ø	24
CA3800	38 cm Ø	24
CA4300	43 cm Ø	24



Motif spécial CA1300-E01
MERCI



Plateau ovale

Code	Description	UE
CA1623	16 x 23 cm	24
CA2026	20 x 26,5 cm	24
CA2129	21 x 29 cm	24

Plateau trapézoïdal

Code	Description	UE
CA3247TR	32 x 47 cm	24

Couleur disponible

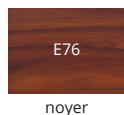

Couleurs CA4064H sur commande

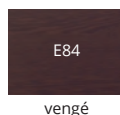

Couleurs sur commande

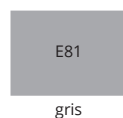
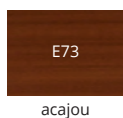

Tous les prix sont indiqués en P.V.P. unitaire.

■ Plateaux stratifiés CORFÚ

Surface antidérapante



Plateau rectangulaire

Code	Description	Couleurs	UE
CO2632	26,5 x 32,5 cm	D01 ■ D02 ■	12
CO3253	32,5 x 53 cm	D01 ■ D02 ■	12
CO3343	33 x 43 cm	D01 ■ D02 ■	12
CO3646	36 x 46 cm	D01 ■ D02 ■	12
CO3753	37 x 53 cm	D01 ■ D02 ■	12

Plateau rond

Code	Description	Couleurs	UE
CO3200	32 cm	D01 ■ D02 ■	12
CO3800	38 cm	D01 ■ D02 ■	12
CO4300	43 cm	D01 ■ D02 ■	12

■ Plateaux stratifiés MYKONOS

Surface antidérapante



Plateau rectangulaire

Code	Description	UE
MY2632	26,5 x 32,5 cm	24
MY2738	27 x 38 cm	24
MY3244	32 x 44 cm	24
MY3253	32,5 x 53 cm	24
MY3343	33 x 43 cm	24
MY3446	34 x 46 cm	24
MY3646	36 x 46 cm	24
MY3753	37 x 53 cm	24
MY3952	39 x 52 cm	24
MY4361	43 x 61 cm	24

Plateau rond

Code	Description	UE
MY3200	32 cm Ø	24
MY3800	38 cm Ø	24
MY4300	43 cm Ø	24

Plateau ovale

Code	Description	UE
MY2026	20 x 32 cm	24
MY2129	21 x 29 cm	24



Couleurs Plateau Mykonos

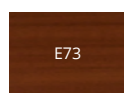

E73
acajou

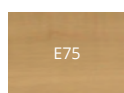

E75
bouleau

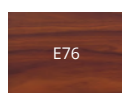

E76
noyer

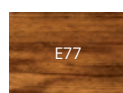

E77
teck

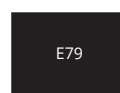

E79
noir

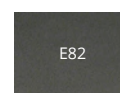

E82
granit anthracite

Tous les articles en **gras** sont des produits de stock habituel. Consulter les couleurs disponibles.



■ Plateaux stratifiés MADEIRA

Surface lisse

Sa grande variété de couleurs et de textures confère au plateau Madeira l'aspect naturel du bois.



Plateau rond

Code	Description	UE
MA3200	32 cm Ø	24
MA3800	38 cm Ø	24
MA4300	43 cm Ø	24

Plateau trapézoïdal

Code	Description	UE
MA3652TR	36 x 52 cm	24

Plateau rectangulaire

Code	Description	UE
MA2028	20 x 28 cm	24
MA2435	24 x 35 cm	24
MA3343	33 x 43 cm	24
MA3646	36 x 46 cm	24
MA3753	37 x 53 cm	24
MA4361	43 x 61 cm	12
MA3142H	à poignées - 31 x 42 cm	24



Couleurs Plateau Madeira



Tous les prix sont indiqués en P.V.P. unitaire.

PERSONNALISATION DES PLATEAUX



Nous proposons une personnalisation sur la plupart des plateaux. Cherchez le logo



Fidèles à notre engagement de vous offrir la plus grande valeur ajoutée, nous personnalisons vos plateaux en fonction de vos besoins.

Améliorez votre image de marque ou démarquez-vous des autres en personnalisant vos plateaux.

Pour plus d'information, consultez notre **GUIDE DE PERSONNALISATION** à la fin de ce catalogue.



CAMBRO

Accédez aux principaux outils de Cambro

L'application Cambro vous donne instantanément accès aux principaux outils et aux ressources de Cambro.

De la personnalisation d'un plateau jusqu'à la découverte de la gamme complète de conteneurs de Cambro.

<https://www.cambro.com/app/>

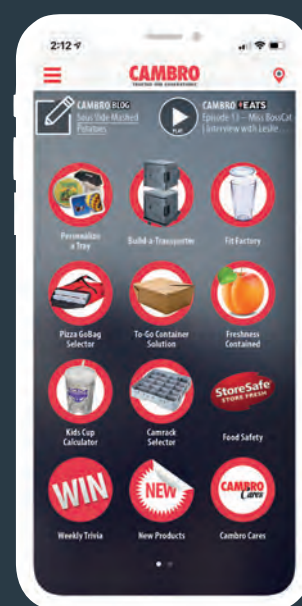

Tous les articles en **gras** sont des produits de stock habituel. Consulter les couleurs disponibles.



■ Plateaux de Fast Food

Plateaux en polypropylène, légers, économiques et idéales pour le service de restauration rapide.



1014FF

Plateau Fast Food

26,5 x 34,5 cm

🗑️ 24



1216FF

Plateau Fast Food

30 x 41 cm

🗑️ 24



1418FF

Plateau Fast Food

36 x 46 cm

🗑️ 12



1217FFH

Plateau Fast Food à poignées

30 x 43 cm

🗑️ 24

Couleurs disponibles en stock habituel : negro (110). Ce produit n'est pas personnalisable.

Couleurs disponibles

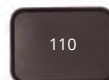

noir

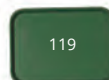

vert Sherwood



rouge

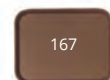

brun



bleu marine

Couleurs sur commande



brun désert

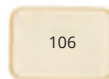

pêche claire



gris perle



jaune primevère



orange



bleu



vieux rose



vert turquoise

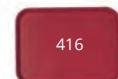

groseille

Tous les prix sont indiqués en P.V.P. unitaire.

Plateaux à compartiments

Usage spécifique

Plateaux compartimentés avec différentes configurations pour s'adapter à tout besoin de service. Idéals pour les crèches, les écoles et les cantines où il est nécessaire de réduire le nombre de pièces de vaisselle. Fabriqués en polycarbonate, ABS, plastique résistant à la chaleur ou copolymère, ce sont les plus économiques et font également preuve d'une bonne résistance et performance.



uniquement polycarbonate



uniquement polycarbonate

Plateau en polycarbonate 7 compartiments

Code	Description	Couleurs	UE
14187TRCW	45,6 x 35,4 x 4 cm	133	12



Plateau en polycarbonate 6 compartiments

Code	Description	Couleurs	UE
10146CW	25,4 x 36,5 cm	145 133 119 186 416 110	24
915CW	22,2 x 38 cm	133 119 168 186 404 414 416 110 431	24
1596CW	22,9 x 38 cm	133 119 168 186 404 414 416 110 431	24
10146DCW	25,4 x 36 x 2,9 cm	133	24



Plateau en polycarbonate 5 compartiments

Code	Description	Couleurs	UE
1411CW	36,5 x 26,8 x 3,3 cm	133	24
10145CW	25,4 x 36,8 cm	133	24
14105CW	27,2 x 35,2 cm	133	24



Plateau en polycarbonate 4 compartiments

Code	Description	Couleurs	UE
9114CW	23 x 28 x 6,5 cm	133 414	24



Plateau en polycarbonate 3 compartiments

Code	Description	Couleurs	UE
9113CW	23 x 28 x 6,5 cm	133 414	24



Plateau division 3 compartiments

Code	Description	Couleurs	UE
853FH	Haute temp. - 22,1 x 16 x 4,8 cm	150	24

Tous les articles en **gras** sont des produits de stock habituel. Consulter les couleurs disponibles.

■ Plateaux à compartiments (suite)

Usage spécifique

Plateau en copolymère 6 compartiments

Code	Description	Couleurs	UE
PS1014	25,4 x 36,5 cm	437 ■ 145 ■ 161 ■ 186 ■ 414 ■ 416 ■	24
915CP	22,2 x 38 cm	186 ■ 416 ■	24
1596CP	22,9 x 38 cm	186 ■ 416 ■	24
10146DCP	25,4 x 36 x 2,9 cm	161 ■ 414 ■ 167 ■	24



10146DCP

Plateau en copolymère 5 compartiments

Code	Description	Couleurs	UE
14105CP	25,4 x 36,5 cm	161 ■	24
1411CP	22,2 x 38 cm	161 ■ 167 ■	24

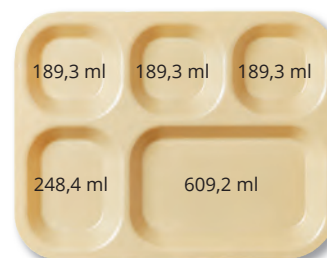

14105CP

Plateau en copolymère 4 compartiments

Code	Description	Couleurs	UE
9114CP	23 x 28 x 6,5 cm	161 ■ 167 ■ 414 ■	24



9114CP

Plateau en copolymère 3 compartiments

Code	Description	Couleurs	UE
9113CP	23 x 28 x 6,5 cm	161 ■ 167 ■ 414 ■	24



9113CP

Couvercle pour plateau

Code	Description	Couleurs	UE
911CWC	Pour 9113CW et 9114CW	135 □	24
10146DCWC	Pour 10146DCW	135 □	24
911CPC	Pour 9113CP et 9114CP	135 □	24
10146DCPC	Pour 10146DCP	135 □	24



Plateau-base 10146CW avec couvercle 10146DCWC



Plateau en ABS 6 compartiments

Code	Description	Couleurs	UE
BCT1014	25,4 x 36,5 cm - 6 comp.	119 ■ 161 ■ 186 ■ 414 ■ 416 ■ 163 ■	24

Tous les prix sont indiqués en P.V.P. unitaire.

Plateaux Camwear

Usage spécifique

Plateaux fabriqués en polycarbonate. Pratiquement incassables et très légers. Idéals pour le service en cafétérias avec fréquentation élevée.



1418CW



1520CWH



1418TRCW

Plateau rectangulaire - rebord élevé

Code	Description	Couleurs	UE
1418CW	35,5 x 46 cm	168 ■ 133 ■ 148 ■ 485 ■ 488 ■	12
1520CW	38 x 51 cm	168 ■ 133 ■ 148 ■ 485 ■ 488 ■	12

Plateau rectangulaire - rebord élevé avec poignées

Code	Description	Couleurs	UE
1418CWH	35,5 x 46 cm	168 ■ 133 ■ 148 ■ 485 ■ 488 ■	12
1520CWH	38 x 51 cm	168 ■ 133 ■ 148 ■ 485 ■ 488 ■	12

Plateau trapézoïdal - rebord élevé

Code	Description	Couleurs	UE
1418TRCW	35,5 x 46 cm	168 ■ 133 ■ 148 ■ 485 ■ 488 ■	12

Plateaux et bacs de présentation

Usage spécifique

Plateaux et bacs fabriqués en fibre de verre, conçus pour mettre en valeur vos produits en vitrines, buffets et socles de présentation.



Plateau

Code	Description	UE
630MT	16,4 x 76,2 x 1,9 cm	12
826MT	21,6 x 64,1 x 1,9 cm	12
830MT	21,4 x 76,2 x 1,9 cm	12
913MT	22 x 31,6 x 2,1 cm	12
918MT	22 x 45,7 x 2,1 cm	12
926MT	22,5 x 64,9 x 2,5 cm	12
1015MT	25,7 x 38,1 x 1,9 cm	12
1030MT	26,5 x 76,2 x 1,9 cm	12
1218MT	29,2 x 45,1 x 2,5 cm	12
1224MT	31,6 x 61 x 1,9 cm	12
1230MT	31,6 x 76,2 x 1,9 cm	12
1318MT	32,1 x 45,1 x 2,7 cm	12
1826MT	45,2 x 65,2 x 2,7 cm	6
2025MT	52,7 x 64,9 x 2,9 cm	6



Bac

Code	Description	UE
6302MT	16,7 x 76,2 x 5,1 cm	12
8262MT	21,5 x 64,1 x 5,1 cm	12
8302MT	21,4 x 76,2 x 5,1 cm	12
92615MT	22,5 x 64,8 x 3,8 cm	12
10302MT	26,5 x 76,2 x 5,1 cm	12

Couleurs plateau Market



Tous les articles en **gras** sont des produits de stock habituel. Consulter les couleurs disponibles.

■ Plateaux Cam GoBox

Usage spécifique

Plateaux isothermes fabriqués en polypropylène expansé, matériau ultraléger et 100% recyclable qui conserve en toute sécurité les aliments à température pendant une heure.



Plateau sans vaisselle

Code	Description	Couleurs	UE
ITENEPP	37 x 53 x 11,8 cm	107 ■	1

Plateau avec vaisselle

Code	Description	Couleurs	UE
ITENEPP21H	37 x 53 x 11,8 cm	107 ■	1



Vaisselle

Code	Description	UE
122 400 021	Assiette en porcelaine, 21 cm Ø	1
122 600 021	Couvercle assiette 122400021, 21,5 cm Ø	1
MDSB16	Bol Shoreline isotherme 500 ml Couleurs: 110 ■ 447 ■ 457 ■ 480 ■ 487 ■ 497 ■	48
122 700 014	Couvercle bol, 14,5 cm Ø	1

■ Nouveauté ■

■ Simple service

Il se compose d'une assiette et d'un couvercle avec 3 ramequins en forme de larme qui permettent de créer une combinaison unique. Le blanc offre un contraste parfait qui contribue à rehausser l'attrait visuel de vos salades et accompagnements.

10762	10763
Assiette avec couvercle	Ramequin pour assiette
23,5 Ø x 6,7 cm, 1 Litro	10762
1	250 ml
9,00 €	2,14 €

Couvercle acrylique transparent pour faciliter la visibilité du contenu



Tous les prix sont indiqués en P.V.P. unitaire.

Plateau isotherme fabriqué en polypropylène avec mousse isolante incorporée. Il offre un système de plaque chaude qui permet de maintenir les aliments à une température supérieure à 64°C. Les plateaux avec vaisselle incluent ce système de plaque chauffante 165PW.

Modèle ITP3753 sans plaque chauffante

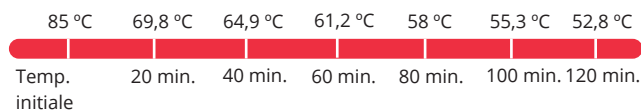

Plateau avec vaisselle

Code	Description	Couleurs	UE
ITPD3753T	37 x 53 x 10,5 cm	Gris et bleu	1
ITPD3253	32,5 x 53 x 10,5 cm	Deux tonalités de gris	1



Plateau sans vaisselle

Code	Description	Couleurs	UE
IT3753T	37 x 53 x 10,5 cm	Gris et bleu	1



Accessoires

Code	Description	UE
122 400 050	Assiette en porcelaine de 2 comp. - 25,6 cm Ø	1
122 450 050	Bol en porcelaine - 14,2 cm Ø - 500 ml	1
122 500 050	Bol en porcelaine - 12,2 cm Ø - 400 ml	1
122 600 050	Couvercle pour assiette	1
122 650 050	Couvercle pour bol 122 450 050	1
122 700 050	Couvercle pour bol 122 500 050	1
112 430 000	Carte menu jaune - 100 x 70 mm	1
165PW	Plaque chauffante en SMC - 16,5 cm Ø	1

Tous les articles en **gras** sont des produits de stock habituel. Consulter les couleurs disponibles.

Boîte à repas à 2 compartiments

Cette boîte à deux compartiments est idéale pour un seul repas. Les deux compartiments ont leur propre couvercle ce qui permet une séparation totale pour maintenir les températures froides ou chaudes. Idéal en collectivité, Maison de retraite, écoles, hopitaux y pour les traiteurs.

EPPMDB4428

Boîte à repas à 2 compartiments

43,7 x 27,6 x 17,5 cm (ext.)

22,6 x 18,3 x 10,9 cm (int.)

1

159



A. Récipient : 22,6 x 18,3 x 10,9 cm

B. Récipient : 22,6 x 18,3 x 10,9 cm



Boîte à repas à 4 compartiments

Código	Descripción	Colores	UE
EPPMD4835	4 compartiments 42 x 29 x 11 cm (int) 48 x 35 x 16,7 cm (ext)	159	1



Compartiment pour aliment froids
Pour des plats de 21 x 21 x 11 cm

Compartiment pour aliments chauds
pour des plats de 19 x 19 x 11 cm

Pour un fruit ou du pain
18 x 8 x 11 cm

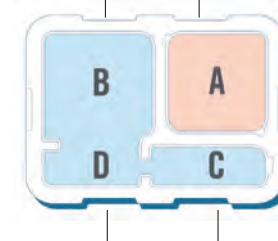

Pour une bouteille et des couverts
21 x 8,5 x 11 cm

Rejoignez-nous



@DbmarkTweet



@dbmarkhosteleria



@dbmark_inst

Tous les prix sont indiqués en P.V.P. unitaire.



Au-delà de vos cuisines et de vos salles de restauration, les parcs et terrasses de votre établissement ou encore les abords de la piscine sont une excellente opportunité de rentabiliser vos opérations grâce aux équipements de vente mobiles avec lesquels vous pourrez transformer vos espaces extérieurs en points générateurs de revenus. Choisissez parmi une variété de chariots de vente mobiles, des meubles de buffet portables ou des comptoirs roulants et combinez-les avec les accessoires présentés dans les pages suivantes.

Vous trouverez également des solutions essentielles et professionnelles pour votre barre, une large gamme d'articles et d'accessoires pratiques et élégants, pour optimiser votre travail en salle ou au comptoir, afin que vous puissiez prêter la plus grande attention à vos clients.

■ Système de buffets Versa

Faites votre choix parmi une large gamme de meubles buffets portables pour présenter vos salades tout en maximisant l'espace de vos locaux ou en améliorant le flux de votre clientèle. Chaque partie est constituée d'une seule pièce d'acier inoxydable et dotée d'un protecteur hygiénique et sanitaire. Les glissières à plateaux sont en option.



VBR5
Buffet Versa avec roues standards
175,3 x 108 x 159,4 cm
🗑️ 1

VBR6
Buffet Versa avec roues standards
208,3 x 108 x 159,4 cm
🗑️ 1



VCSWR
Chariot Versa pour caisse enregistreuse avec roues standards et 2 tablettes
134 x 81,9 x 109,2 cm
🗑️ 1



VCSWRHD
Chariot Versa pour caisse enregistreuse avec roues renforcées et 2 tablettes
134 x 81,9 x 109,2 cm
🗑️ 1



VBRT5
Plan de travail Versa avec roues standards
175,3 x 108 x 159,4 cm
🗑️ 1

VBRT6
Plan de travail Versa avec roues standards
208,3 x 108 x 159,4 cm
🗑️ 1

VCS
Chariot Versa pour caisse enregistreuse avec roues standards, sans tablette pour plateaux
81,9 x 81,3 x 109,2 cm
🗑️ 1

VCSHD
Chariot Versa pour caisse enregistreuse avec roulettes à grande résistance, sans tablette pour plateaux
81,9 x 81,3 x 109,2 cm
🗑️ 1



VBRU5
Buffet Versa avec roues standards et compartiment de stockage
175,3 x 108 x 159,4 cm
🗑️ 1

VBRU6
Buffet Versa avec roues standards et compartiment de stockage
208,3 x 108 x 159,4 cm
🗑️ 1

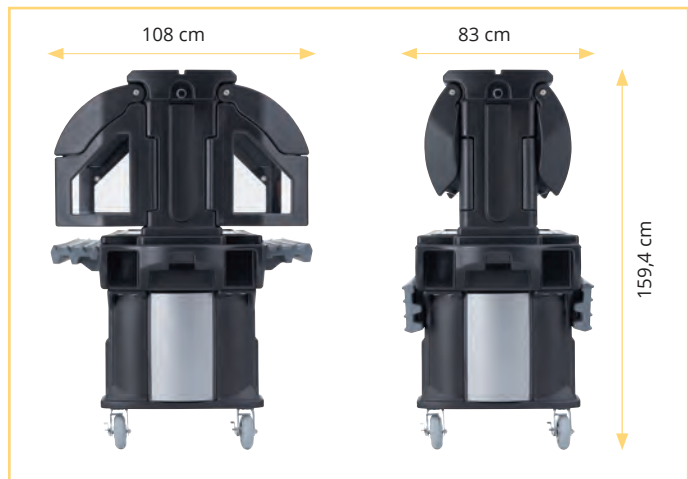

■ Installez ou refermez l'auvent d'hygiène ainsi que les tablettes latérales en quelques secondes pour un transport et un stockage facile.

Couleurs disponibles : ● 110 | Couleurs sur commande : ● 158 ● 186 ● 519

Tous les prix sont indiqués en P.V.P. unitaire.



VBRC

Raccord droit de buffet à buffet

68,5 x 48,3 x 10,8 cm



VBRC90

Raccord d'angle de buffet à buffet

91,4 x 91,4 x 10,8 cm



VCS32CNT

Raccord droit de chariot à plan de travail/buffet de hauteur standard

68,6 x 51,7 x 8,3 cm



VCSCNL

Raccord droit de chariot à plan de travail/buffet bas

68,6 x 51,8 x 21,6 cm



Couleurs disponibles : ● 110 | Couleurs sur commande : ● 158 ● 186 ● 519

■ Buffets de table, buffets bar et auvents d'hygiène

6FBRTT

Buffet Ultra de table pour 5 bacs GN 1/1

183 x 85 x 69 cm



5FBRTT

Buffet Ultra de table pour 4 bacs GN 1/1

152 x 85 x 69 cm



4FBRTT

Buffet Ultra de table pour 3 bacs GN 1/1

130 x 85 x 69 cm



BUF72

Base buffet bar Ultra de table pour 5 bacs GN 1/1

171,5 x 61 x 18 cm



BUF48

Base buffet bar Ultra de table pour 3 bacs GN 1/1

106 x 61 x 18 cm



Couleurs disponibles : ● 110 | Couleurs sur commande : ● 158 ● 186 ● 519

Tous les articles en **gras** sont des produits de stock habituel. Consulter les couleurs disponibles.

■ Buffets de table, buffets bar et auvents d'hygiène (suite)

BBR720

Buffet Ultra de table
pour 5 bacs avec auvent

188 x 61 x 62 cm



BBR480

Buffet Ultra de table
pour 3 bacs avec auvent

122 x 61 x 62 cm



FSG720

Auvent d'hygiène autonome

188 x 42 x 62 cm



FSG480

Auvent d'hygiène autonome

122 x 42 x 62 cm



Couleurs disponibles : ● 110 | Couleurs sur commande : ● 158 ● 186 ● 519

■ Accessoires pour buffets

VBRTBL

Tablette rallonge
pour buffet et plan de travail
Versa

68,6 x 55,9 x 11,4 cm



● 110 ● 191

VBRR5

Glissière à plateaux
pour module 152 cm
pour buffet Versa

134,6 x 29,2 x 11,6 cm



● 191

VBRR6

Glissière à plateaux
pour module 183 cm
pour buffet Versa

167,6 x 29,2 x 11,6 cm



● 191

VCS32R

Glissière à plateaux
pour chariot Versa

71,1 x 29,7 x 12,7 cm



● 191

VBRCVR5

Housse vinyle pour buffet
Versa de 152 cm

185 x 111 x 117 cm



VBRCVR6

Housse vinyle pour buffet
Versa de 183 cm

211 x 111 x 117 cm



VBRTCVR5

Housse vinyle pour plan
de travail Versa de 152 cm

178 x 85 x 53 cm



VBRTCVR6

Housse vinyle pour plan
de travail Versa de 183 cm

211 x 85 x 53 cm



Tous les prix sont indiqués en P.V.P. unitaire.

■ Modèle de configuration de buffet



Modèle de 152 cm



Modèle de 183 cm



Barrette de composition Petit déjeuner à emporter

Variété de fruit à la pièce (bananes, oranges, etc.)	Yahourt et fromage blanc	Jus de fruit et variété de lait	Céréales et barres de céréales	Madeleines intégrales
------------------------------------------------------	--------------------------	---------------------------------	--------------------------------	-----------------------

Thème Rainbow

Salade	Tomates	Carottes	Epinard	Courgette	Pois chiches	Pêche	Fraises
			Brocolis				
			Céleri	Choux fleur	Champignons	Melon	Raisin

Barrette de composition Snack

Variété de salades	Assaisonnements pour salades	Noix, fruits secs et croustons	Variété de sandwichs	Hummus et carottes	Yahourt et fromage blanc	Variété de fruits (bananes, oranges, etc.)
						Fruits en morceau, pudding gélatine et pudding

Thème Taco

Salade	Tomates	Guacamole	Oignons
	Tortillas de maïs	Poivrons verts	Sauce
		Poivrons rouges	Fromage

Thème Chili

Tortillas de maïs	Salade	Guacamole	Tomates
	Crème fraîche	Oignons	Maïs
	Sauce	Poivrons verts	Champignons

Thème Burger

Salade	Encurtidos	Ketchup	Fromage	Poivrons verts	Oignons
	Guacamole	Sauce	Tomates	Poivrons rouges	Champignons
	Sauce de tomate	Moutarde	Épinards		

Tous les articles en **gras** sont des produits de stock habituel. Consulter les couleurs disponibles.

Accessoires pour chariot



VCSCVR

Housse vinyle pour chariot
Versa

107 x 84 x 92 cm

1

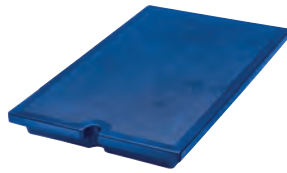

VBRWC

Couvercle de cuve Versa

53 x 33 x 5,1 cm

1

● 110 ● 158 ● 186 ● 519



VBRSHTS

Porte-enseigne pour buffet
Versa

91,4 x 15,2 x 23,5 cm

1



DIV12

Barrettes de composition

32,5 cm

1

○ 135 ○ 148



DIV20

Barrettes de composition

53 cm

1

○ 135 ○ 148



CPH3

Porte-pots de 1,4 et 2,4 L

33 x 53 cm

1

○ 148 ● 191



SBH15

Porte-saladier pour saladier
de 38 cm et 3 pots

65,5 x 56 cm

1

○ 148 ● 191



SBH18

Porte-saladier pour saladier
de 45,7 cm

65,5 x 53 cm

1

○ 148 ● 191



VCS32KEYT

Support à clavier
pour chariot Versa

52,4 x 25,7 x 5 cm

1

● 110



Tous les prix sont indiqués en P.V.P. unitaire.

Chariots et système Camkiosk

Si votre établissement dispose d'un flux de client élevé, c'est certainement l'équipement qu'il vous faut. Nos chariots de vente mobile sont idéals pour les parcs d'attractions, les parcs d'expositions, les centres de conventions ou les parcs d'affaires. Grâce à leur design remarquable et attrayant, l'investissement s'amortit très rapidement en augmentant l'achat d'impulsion.



KVC854

Chariot Camkiosk
avec 4 cuves pour bacs GN

216 x 85 x 179 cm



KVC854C

Chariot Camkiosk
avec 4 cuves pour bacs GN
et auvent

216 x 85 x 239 cm



KVC856

Chariot Camkiosk
avec 6 cuves pour bacs GN

216 x 85 x 179 cm



KVC856C

Chariot Camkiosk
avec 6 cuves pour bacs GN
et auvent

216 x 85 x 239 cm



KWS40

Module de travail Camkiosk

103 x 84 x 116 cm



KSC402220

Évier sur roues 220 v.
Camkiosk

103 x 83 x 116 cm



WCR1220

Couvercle de cuve
pour chariot Camkiosk

53,5 x 33 x 5 cm



ES28RL

Meuble pour caisse enregistreuse avec
tablette des deux côtés

112 x 71 x 99 cm



ES28

Meuble pour caisse enregistreuse

71 x 71 x 99 cm



Couleurs chariot : ● 158 ● 186 - Couleur auvent : ● 157 | Couleurs chariot : ● 191 ● 192 ● 426 ● 519 - Couleur auvent : ● 519

Tous les articles en **gras** sont des produits de stock habituel. Consulter les couleurs disponibles.

Voiture ambulantes Camcruiser

Augmentez vos ventes au-delà de la cafétéria avec le chariot de vente mobile Camcruiser, conçu pour vous accompagner partout où vous allez. Parfait pour le petit déjeuner, le déjeuner, la vente en plein air, la vente à emporter ou à la carte. Comprend deux compartiments isothermes pour le stockage des denrées alimentaires.



CVC724

Voiture ambulante Camcruiser avec 4 bacs GN 1/1

189 x 81 x 130 cm



CVC72

Voiture ambulante Camcruiser avec 1 bac GN 1/1 y 2 bacs de 56 x 39 x 15 cm

189 x 81 x 130 cm



CVC55

Voiture ambulante Camcruiser avec 1 bac GN 1/1

140 x 80 x 130 cm



CB1220

Planche à découper pour Camcruiser

53 x 33 x 1,3 cm



○ 148



CP3253

Plaque eutectique Camchiller GN 1/1

53 x 32,5 x 3 cm



● 443



WCR1220

Couvercle de cuve

53,5 x 33 x 5 cm



● 110 ● 158 ● 186 ● 191
● 192 ● 194 ● 516

Tableau des capacités

CVC724		CVC72	
Comp. fermé	Comp. ouvert	Comp. fermé	Comp. ouvert
2 GN1/1 de 20 cm +	Tiroir caisse	2 GN1/1 de 20 cm +	Tiroir caisse
2 GN1/1 de 6,5 cm ou	1 GN1/1 de 15 cm ou	2 GN1/1 de 6,5 cm ou	1 GN1/1 de 15 cm ou
4 GN1/1 de 15 cm ou	2 GN1/1 de 10 cm ou	4 GN1/1 de 15 cm ou	2 GN1/1 de 10 cm ou
6 GN1/1 de 10 cm ou	3 GN1/1 de 6,5 cm	6 GN1/1 de 10 cm ou	3 GN1/1 de 6,5 cm
8 GN1/1 de 6,5 cm ou		8 GN1/1 de 6,5 cm ou	
4 Camtray 2025 ou		4 Camtray 2025 ou	
8 Camtray 3253		8 Camtray 3253	

Couleur chariot	110	158	191	192	519
Couleur parasol	White/Black	White/Red	White/Black	White/Dark Green	White/Dark Green

Tous les prix sont indiqués en P.V.P. unitaire.

■ Bars mobiles Cambars

Les bars mobiles de CAMBRO ont contribué, depuis de nombreuses années, à augmenter les bénéfices des hôteliers et de leur département boissons grâce à leurs designs attrayants et à la fois pratique. Consultez les couleurs et décors disponibles.



BAR730PMT220

Bar mobile, système intégral avec revolver à boissons post-mix et réservoir d'eau 220 v.

184,8 x 66 x 121,9 cm



BAR730DSPMT2

Bar mobile, système intégral avec revolver à boissons post-mix et réservoir d'eau 220 v. Décor Designer

197,2 x 72,4 x 120,7 cm



BAR730DX

Bar mobile, système intégral avec revolver à boissons pré-mix.

184,8 x 66 x 121,2 cm



BAR730SDSX

Bar mobile, système intégral avec revolver à boissons pré-mix. Décor Designer

197,2 x 72,4 x 120,7 cm



BAR730CP

Bar mobile système de base. Décor standard

184,8 x 66 x 121,9 cm



BAR730DSCP

Bar mobile système de base. Décor standard

184,8 x 66 x 121,9 cm



BAR730

Bar mobile système de base. Décor standard

184,8 x 66 x 121,9 cm



BAR730DS

Bar mobile système de base. Décor Designer

197,2 x 72,4 x 120,7 cm



BAR650PMT220

Bar mobile, système intégral avec revolver à boissons post-mix et réservoir d'eau 220 v.

171,5 x 72,4 x 120,7 cm



BAR650DSPMT2

Bar mobile, système intégral avec revolver à boissons post-mix et réservoir d'eau 220 v. Décor Designer

171,5 x 72,4 x 120,7 cm



BAR650DX

Bar mobile, système intégral avec revolver à boissons pré-mix.

171,5 x 72,4 x 120,7 cm



BAR650SDSX

Bar mobile, système intégral avec revolver à boissons pré-mix. Décor Designer

171,5 x 72,4 x 120,7 cm



Tous les articles en **gras** sont des produits de stock habituel. Consulter les couleurs disponibles.

■ Bars mobiles Cambars (suite)



BAR650CP

Bar mobile système de base.
Décor standard

171,5 x 72,4 x 120,7 cm



BAR650DSCP

Bar mobile système de base.
Décor standard

171,5 x 72,4 x 120,7 cm



BAR650

Bar mobile système
économique.
Décor standard

171,5 x 72,4 x 120,7 cm



BAR650DS

Bar mobile système
économique.
Décor Designer

171,5 x 72,4 x 120,7 cm



BAR540

Bar mobile système
économique. Décor standard

137,2 x 65,7 x 117,2 cm



BAR540DS

Bar mobile système
économique. Décor Designer

137,2 x 65,7 x 117,2 cm



650WS

Étagère en fil métallique
pour BAR650



730WS

Étagère en fil métallique
pour BAR730



730SR

Panier « service rapide »
7 bouteilles



BAR54SR

Panier « service rapide »
5 bouteilles

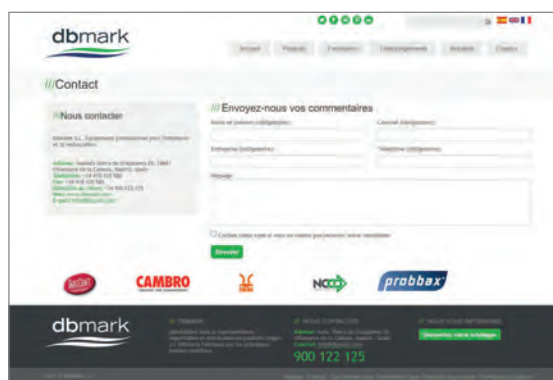

N'hésitez pas à nous consulter.

Dans la section de contact de notre site vous pourrez trouver nos informations de contact (adresse, téléphone, e-mail, etc.).

Vous pouvez également nous poser vos questions ou commentaires.

www.dbmark.com

Tous les prix sont indiqués en P.V.P. unitaire.

■ Chariots à glace SLIDINGLIS

Utilisez les chariots à glace en plein air, dans les parcs et les piscines pour fournir de la glace dans les lieux où vous ne pouvez pas utiliser ou déplacer une machine à glaçons conventionnelle. Dans nos chariots, la glace se conserve en excellent état pendant des heures.



ICS100L

Chariot à glaçons bas avec 2 roues pivotantes et 2 roues à frein

77 x 57 x 73 cm

Capacité : 46 kg



ICS100L4S

Chariot à glaçons bas avec 4 roues pivotantes et 1 roue à frein

77 x 57 x 73 cm

Capacité : 46 kg



ICS125L

Chariot à glaçons bas avec 2 roues fixes, 2 roues pivotantes et 1 roue à frein

80 x 58,5 x 74,5 cm

Capacité : 57 kg



ICS125LB

Chariot à glaçons bas avec 2 roues «easy wheel» de 20,3 cm

80 x 58,5 x 74,5 cm

Capacité : 57 kg



ICS175L

Chariot à glaçons bas avec 2 roues fixes, 2 roues pivotantes et 1 roue à frein

95,5 x 61 x 74,5 cm

Capacité : 80 kg



ICS175LB

Chariot à glaçons bas avec 2 roues pivotantes et 1 roue à frein et 2 roues «easy wheel» de 25,4 cm

95,5 x 61 x 74,5 cm

Capacité : 80 kg



ICS125T

Chariot à glaçons haut avec 2 roues fixes, 2 roues pivotantes et 1 roue à frein

80 x 58,5 x 88 cm

Capacité : 57 kg



ICS175T

Chariot à glaçons haut avec 2 roues fixes, 2 roues pivotantes et 1 roue à frein

86,5 x 58,5 x 95,5 cm

Capacité : 80 kg



ICS175TB

Chariot à glaçons haut avec 2 roues pivotantes et 1 roue à frein et 2 roues «easy wheels» de 25,4 cm

86,5 x 58,5 x 95,5 cm

Capacité : 80 kg



ICS200TB

Chariot à glaçons haut avec 2 roues pivotantes et 1 roue à frein et 2 roues «easy wheels» de 25,4 cm

86,5 x 58,5 x 100,5 cm

Capacité : 91 kg



Couleurs disponibles : ● 131 | Couleurs sur commande : ● 110 ● 157 ● 191 ● 401

Tous les articles en **gras** sont des produits de stock habituel. Consulter les couleurs disponibles.



■ Récipients Pourmaster

Articles professionnels bien conçus pour votre bar. Faciles à utiliser et à nettoyer.



N32A

Set récipients PourMaster avec bec verseur long. Assortiment, 2 de chaque couleur

8,9 x 8,9 x 40 cm



1

● BR ● GN ○ WH ● R ● X ● Y

N32BR

Récipients PourMaster avec bec verseur long. Marron

8,9 x 8,9 x 40 cm - 1 L



12

● BR

N32GN

Récipients PourMaster avec bec verseur long. Vert

8,9 x 8,9 x 40 cm - 1 L



12

● GN

N32R

Récipients PourMaster avec bec verseur long. Rouge

8,9 x 8,9 x 40 cm - 1 L



12

● R

N32W

Récipients PourMaster avec bec verseur long. Blanc

8,9 x 8,9 x 40 cm - 1 L



12

○ WH

N32X

Récipients PourMaster avec bec verseur long. Orange

8,9 x 8,9 x 40 cm - 1 L



12

● X

N32Y

Récipients PourMaster avec bec verseur long. Jaune

8,9 x 8,9 x 40 cm - 1 L



12

● Y

N32VA

Set récipients PourMaster avec bec verseur en V. Assortiment, 2 de chaque couleur

8,9 x 8,9 x 40 cm - 1 L



1

● BR ● GN ○ WH
● R ● X ● Y



N32LPA

Set récipients PourMaster avec bec verseur court. Set, 2 de chaque couleur.

8,9 x 8,9 x 24,1 cm - 1 L



1

● BR ● GN ○ WH
● R ● X ● Y



Tous les prix sont indiqués en P.V.P. unitaire.

Récipients Pourmaster (suite)

8032A

Set récipients PourMaster unité completa. Assortiment, 2 de chaque couleur

9,4 x 9,4 x 34,6 cm
1 L - 12 unidades

1

8032GN

Récipient PourMaster unité entière. Vert

9,4 x 9,4 x 34,6 cm
1 L

12

GN

8032R

Récipient PourMaster unité entière. Rouge

9,4 x 9,4 x 34,6 cm
1 L

12

R

8032X

Récipient PourMaster unité entière. Orange

9,4 x 9,4 x 34,6 cm
1 L

12

X

8032W

Récipient PourMaster unité entière. Blanc

9,4 x 9,4 x 34,6 cm
1 L

12

WH

8032Y

Récipient PourMaster unité entière. Jaune

9,4 x 9,4 x 34,6 cm
1 L

12

Y

8064A

Set récipients PourMaster unité entière. Assortiment, 1 de chaque couleur

12,2 x 12,2 x 38,7 cm
2 L - 6 unidades

1

BR GN WH
 R X Y

8128A

Set récipients PourMaster unité entière. Assortiment, 1 de chaque couleur

15,2 x 15,2 x 41,9 cm
3,8 L - 6 unidades

1

BR GN WH
 R X Y

JC1064A

Set récipients PourMaster unité de réserve. Assortiment, 1 de chaque couleur

11,1 x 11,1 x 22,2 cm
2 L - 6 unidades

1

BR GN WH
 R X Y

JC1128A

Set récipients PourMaster unité de réserve. Assortiment, 1 de chaque couleur

15,2 x 15,2 x 25,4 cm
3,8 L - 6 unidades

1

BR GN WH
 R X Y



Doseurs - jiggers

1202

Doseur d'alcool avec mesures imprimées - Jigger

5 x 5 x 5 cm

12

INOX.

1203

Doseur d'alcool avec mesures imprimées - Jigger

5,5 x 5,5 x 6 cm

12

INOX.

1204

Doseur d'alcool avec mesures imprimées - Jigger

6 x 6 x 6,5 cm

12

INOX.



1205

Doseur d'alcool avec mesures imprimées - Jigger

6 x 6 x 7 cm

12

INOX.

1206

Doseur d'alcool avec mesures imprimées - Jigger

6,5 x 6,5 x 8 cm

12

INOX.



JJ1202

Jigger japonais mesures imprimées

4,5 x 4,5 x 7,3 cm
Acier inox. - 15/30 ml

6

INOX.

JJ1205

Jigger japonais mesures imprimées

4,6 x 4,6 x 11,1 cm
Acier inox. - 30/45 ml

6

INOX.

JJ1206

Jigger japonais mesures imprimées

4,8 x 4,8 x 12,4 cm
Acier inox. - 30/60 ml

6

INOX.

Tous les articles en **gras** sont des produits de stock habituel. Consulter les couleurs disponibles.



Shakers

Nos shakers apportent charme et sophistication à vos cocktails. Plusieurs tailles et modèles disponibles.



76

Shaker simple acier inox.
8,2 cm de Ø x 12 cm de haut.
475 ml

12

INOX.



77

Shaker simple acier inox.
9,5 cm de Ø x 17,7 cm de haut.
795 ml

12

INOX.



376

Shakers 3 pièces acier inox.
8 cm de Ø x 19 cm de haut.
475 ml

6

INOX.



377

Shakers 3 pièces acier inox.
9,5 cm de Ø x 25,5 cm de haut. 795 ml

6

INOX.



BH377

Shakers 3 pièces acier inox. Ruche
8,6 cm de Ø x 24,8 cm de haut. 710 ml

12

INOX.



1224

Shakers 3 pièces acier inox. Qualité supérieure
9 cm de Ø x 22 cm de haut. 710 ml

4

INOX.

MJS14

Shaker Mason Jar 3 pièces
8,3 cm de Ø x 15,2 cm de haut.

4

MJS30

Shaker Mason Jar 3 pièces
9,5 cm de Ø x 20,3 cm de haut.

4



Tous les prix sont indiqués en P.V.P. unitaire.

Becc verseurs avec doseur

Ils permettent de servir toutes vos boissons avec les mêmes proportions. Le code couleur indique la mesure du tube. Augmenter vos bénéfices en évitant les gâchis.



4244A

Bec verseur Proper Pour

Bec verseur Proper Pour
Plastique - col noir, tube bleu,
bec verseur incolore - 25 ml

3,8 x 3,8 x 9,5 cm

12



35BK

Bec verseur

3,2 x 3,2 x 6,8 cm

Plastique - noir

12



35BL

Bec verseur

3,2 x 3,2 x 6,8 cm

Plastique - bleu

12



35G

Bec verseur

3,2 x 3,2 x 6,8 cm

Plastique - vert

12



35R

Bec verseur

3,2 x 3,2 x 6,8 cm

Plastique - rouge

12



35W

Bec verseur

3,2 x 3,2 x 6,8 cm

Plastique - blanc

12



670

Bec verseur avec buse
chromée sans col

3,1 x 3,1 x 6,9 cm

12



671

Bec verseur avec buse
chromée col noir

3,8 x 3,8 x 6,9 cm

12



330

Bec verseur
conique rapide

3,1 x 3,1 x 11,4 cm

Métal chromé

12



345

Bec verseur super
rapide

3,1 x 3,1 x 12 cm

Métal chromé

12



320A

Bec verseur rapide

3 x 3 x 11,8 cm

Métal chromé

12



598P

Bec verseur avec
bouchon

3 x 3 x 12,1 cm

Métal chromé

12



320C

Bec verseur rapide
avec bouchon

3 x 3 x 12,1 cm

Acier inox.

12



330-S

Bec verseur rapide

3,1 x 3,1 x 12 cm

Acier inox.

12

Tous les articles en **gras** sont des produits de stock habituel. Consulter les couleurs disponibles.

■ Becs verseurs à flux libre



295

Bec verseur avec buse sanitaire plastique.
Incolore

3,5 x 3,5 x 8 cm

🗑️ 12



295X

Bec verseur avec buse sanitaire plastique.
Gris foncé

3,5 x 3,5 x 8 cm

🗑️ 12



1810

Bec verseur de whisky.
Plastique - col noir.
Chromé

🗑️ 12



1802

Bec verseur de whisky.
Plastique - sin col.
Incolore

3,1 x 3,1 x 10,7 cm

🗑️ 12



■ Étagères de service



5122

Étagère de service simple
pour 5 récipients

56 x 10 x 15 cm

🗑️ 1



5132

Étagère de service simple
pour 8 récipients

82 x 11,5 x 16 cm

🗑️ 1



5142

Étagère de service simple
pour 10 récipients

107 x 10 x 15 cm

🗑️ 1



5222

Étagère de service double
pour 10 récipients de 1 L

56 x 20,5 x 24 cm - Acier inox.

🗑️ 1



5242

Étagère de service double
pour 20 récipients de 1 L

107,5 x 21 x 24 cm - Acier inox.

🗑️ 1



101

Boîte de service

24 x 14,5 x 10 cm - ABS noir

🗑️ 12



Rejoignez-nous



@DbmarkTweet



@dbmarkhosteleria



@dbmark_inst

Tous les prix sont indiqués en P.V.P. unitaire.

■ Distributeurs de condiments

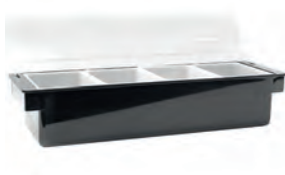

103

Distributeur de condiments avec couvercle

50,2 x 16,5 x 8,3 cm

Couvercle en PC - 4 bacs de 0,7 L



102

Distributeur de condiments avec couvercle

50,2 x 16,5 x 8,3 cm

Couvercle en PC - 4 bacs de 5,7 L



1603

Distributeur de condiments en acier inox. avec couvercle

29,8 x 14 x 11,4 cm

Couvercle en PC - 4 bacs de 0,5 L



1604

Distributeur de condiments en acier inox. avec couvercle

29,8 x 14 x 8,9 cm

Couvercle en PC - 4 bacs de 0,5 L



1605

Distributeur de condiments en acier inox. avec couvercle

38,1 x 14,6 x 8,9 cm

Couvercle en PC - 5 bacs de 0,5 L



1606

Distributeur de condiments en acier inox. avec couvercle

45,7 x 15,2 x 8,9 cm

Couvercle en PC - 5 bacs de 0,5 L



BCD6000

Distributeur de condiments 6 récipients. Méthode FIFO

51,4 x 16,8 x 16,5 cm - 710 ml



BCD6100

Distributeur de condiments 4 récipients. Méthode FIFO

51,4 x 16,8 x 16,5 cm - 1,4 L



■ Nouveauté ■

■ Distributeur de condiments en plastique transparent

Créés en plastique transparent, ces distributeurs sont très légers et disposent d'une chambre à glace qui maintient vos condiments à température idéale et être servis à tout moment.

10006

Distributeur à condiments, 4 inserts

41 x 41,5 x 12,5 cm
700 ml



10007

Distributeur à condiments, 5 inserts

41 x 41,5 x 12,5 cm
565 ml



Tous les articles en **gras** sont des produits de stock habituel. Consulter les couleurs disponibles.

■ Distributeurs de condiments *(suite)*



BCD6105

Réceptacle de rechange pour BDC6000, blanc
7,6 x 12,1 x 13,7 cm - 710 ml



BCD6107

Réceptacle de rechange pour BDC6100, blanc
15,9 x 11,4 x 13,7 cm



Capacité
extra grande

Plastique ABS
durable

Compartment
réfrigéré qui maintient la
fraîcheur de vos aromates



BCD6105BK

Réceptacle de rechange pour BDC6000, noir
7,6 x 12,1 x 13,7 cm - 710 ml



BCD6107BK

Réceptacle de rechange pour BDC6100, noir
15,9 x 11,4 x 13,7 cm



Tous les prix sont indiqués en P.V.P. unitaire.

■ Pelles à glaçons



SCP6CW

Pelle en polycarbonate
16 x 6 x 6,5 cm - 170 gr

🗑️ 12



SCP12CW

Pelle en polycarbonate
27 x 7,5 x 7 cm - 340 gr

🗑️ 12



SCP24CW

Pelle en polycarbonate
17 x 17,3 cm - 680 gr

🗑️ 12



SCP64CW

Pelle en polycarbonate
17 x 17,3 cm - 1.814 gr

🗑️ 6

■ Nouveauté

■ Pelle à glace perforée

Pelle à glace perforée en acier inoxydable.



BSC0610

Pelle perforée
170 - 290 ml

🗑️ 1

● INOX.



BSC1216

Pelle perforée
350 - 470 ml

🗑️ 1

● INOX.



BSC2024

Pelle perforée
590 - 710 ml

🗑️ 1

● INOX.



512

Pelle à glaçons
23 cm de largo

🗑️ 12

● INOX.



605

Pelle à glaçons
18,5 x 7 x 4,5 cm
150 ml

🗑️ 12

● AL



612

Pelle à glaçons
22 x 8 x 5,5 cm
355 ml

🗑️ 12

● AL



624

Pelle à glaçons
26,5 x 10 x 6,5 cm
710 ml

🗑️ 6

● AL



638

Pelle à glaçons
30,5 x 11,5 x 10 cm
1,1 L

🗑️ 6

● AL

Tous les articles en **gras** sont des produits de stock habituel. Consulter les couleurs disponibles.

Pinces y agitateurs



526T
Pinces
17,2 x 1,9 x 1,9 cm
12



532T
Pinces
16,2 x 2,5 x 1,9 cm
12



4403
Pinces
19 cm
12



4404
Pinces
23 cm
12



4405
Pinces
16,5 cm
12



4407
Pinces
23,5 cm
12



H4258
Pilon bout plastique
22 x 2,5 x 2,5 cm
6



H503K
Cuillère à mélanger
avec fourchette
30,5 cm
6



501K
Cuillère à mélanger avec
poignée rouge
27,9 x 3,5 x 1,9 cm
24



BTSP00N
Cuillère à cocktail
et bière en acier inox.
12 cm
12



Accédez aux principaux outils de Cambro

L'application Cambro vous donne instantanément accès aux principaux outils et aux ressources de Cambro.

De la personnalisation d'un plateau jusqu'à la découverte de la gamme complète de conteneurs de Cambro.

<https://www.cambro.com/app/>



Tous les prix sont indiqués en P.V.P. unitaire.

Porte-verres à pied

GHB10

Porte-verres à pied
Métal jaune - 26 cm

🍷 12

GHB16

Porte-verres à pied
Métal jaune - 40,5 cm

🍷 12

GHB24

Porte-verres à pied
Métal jaune - 61 cm

🍷 12

GHC10

Porte-verres à pied
Chromé argent - 26 cm

🍷 12

GHC16

Porte-verres à pied
Chromé argent - 40,5 cm

🍷 12

GHC24

Porte-verres à pied
Chromé argent - 61 cm

🍷 12



Tire-bouchons et décapsuleur



1225

Tire-bouchon
à ailettes

🍷 12



H1229

Tire-bouchon à
ailettes. Qualité
supérieure

19 x 6,7 x 3,8 cm

🍷 12



1226

Tire-bouchon de
sommelier, manche
en plastique noir

11,3 x 2,2 x 1 cm

🍷 24



1228

Tire-bouchon de
sommelier. Qualité
Supérieure en acier
inox.

11,4 x 1,2 x 3,1 cm

🍷 24



396

Décapsuleur plat
en acier inox.

17,7 x 4,4 x 0,6 cm

🍷 36



395

Décapsuleur mural
en acier inox.

5 x 10 x 3 cm

🍷 24

Distributeur de pailles



237

Distributeur de pailles
des deux côtés en acier inox.
24,5 x 18 x 18,5 cm

🍷 1



H714CH

Distributeur de pailles
en verre avec couvercle chromé
11,1 x 11,1 x 28,3 cm

🍷 1



Tous les articles en **gras** sont des produits de stock habituel. Consulter les couleurs disponibles.

■ Bols à punch y seaux à Champagne



PPB15

Bol à punch en polycarbonate
10,6 L - 38,1 cm Ø



○ 176



PPB18

Bol à punch en polycarbonate
19,1 L - 45,7 cm Ø



○ 176



PPB23

Bol à punch en polycarbonate
37,8 L - 58,4 cm Ø



○ 176

WC100CW

Seau à Champagne avec
poignées en polycarbonate
20,3 cm Ø - 23,2 cm altura



WC100CWNH

Seau à Champagne sans
poignées en polycarbonate
20,3 cm Ø - 23,9 cm altura



5188

Seau à Champagne
en acier inox. aspect
miroir

24,1 x 22,2 x 25,4 cm
9,1 L



5198

Seau à Champagne
en acier inox. aspect
martelé

20,3 x 22,2 x 21,5 cm
9,1 L



5288

Pied chromé
pour 5188

76,2 x 19 x 2,5 cm



5388

Pied pliant
chromé pour 5188

34,2 x 34,2 x 74,9 cm



5398

Pied nickelé
pour 5198 et RWB119

22,8 x 22,8 x 59 cm



RIB76

Seau à glace double parois
en acier inoxydable

17,7 x 15,8 x 16,5 cm



H303

Seau à glace double parois
en acier inoxydable
avec pinces

17,8 x 17,8 x 21,6 cm



Tous les prix sont indiqués en P.V.P. unitaire.



■ Accessoires variés

753BK

Tapis de bar en caoutchouc
8,5 x 68,5 x 1 cm



1218BK

Tapis de bar en caoutchouc
45,7 x 30,5 x 1 cm



5833

Tapis de bar, maille
plastique
Blanc - 0,5 x 12 m



5834

Tapis de bar, maille
plastique
Noir - 0,5 x 12 m

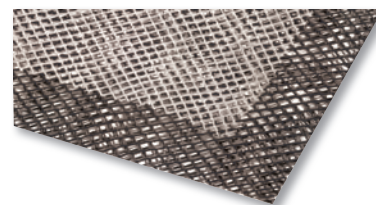

BCD1400

Kit distributeur à
condiments + sucres/
sels bord de verres

63 x 18 x 16 cm



105

Réceptacle de rechange
pour BDC1400

Réceptacle de 500 ml, blanc
14 x 7,5 x 7,5 cm



107

Réceptacle de rechange
pour BDC1400

Réceptacle de 1 L, blanc
14,5 x 14 x 7,5 cm



667

Réceptacle de rechange
pour BDC1400

Éponge pour BDC1400
14,6 x 13,9 x 7,6 cm



Tous les articles en **gras** sont des produits de stock habituel. Consulter les couleurs disponibles.

Accessoires variés (suite)



95

Presse citrons

15,8 x 10,7 x 3,1 cm

🍷 12



S209

Passoire à cocktail

11,4 x 15,2 x 1,9 cm

🍷 12



H633

sucreurs/saleurs bord de verres 3 étages dépliables

16 x 20 x 7,5 cm

🍷 1

Bassines à boissons



BT1914

Bassine à boissons ovale en acier galvanisé, 2 poignées

58 x 37 x 24 cm - 25 L

🍷 1



BT2013

Bassine à boissons ovale en acier inoxydable

52 x 34 x 22 cm - 15 L

🍷 1



BTB1610

Bassine à boissons ovale ronde à double paroi et base

42 x 40 x 24 cm - 27,3 L

🍷 1

RS2132

Seau à boisson rond sur pied et une anse

40,6 x 40,6 x 81,3 cm - 9.8 L

🍷 1



RS1432

Seau à boisson sur pied - style Martini

36,8 x 36,8 x 82,6 cm - 4.4 L

🍷 1



5488W

Refroidisseur à vin en marbre blanc

12,7 cm de Ø x 18,4 cm de haut.

🍷 1



5488

Enfriador de vino de mármol negro

12,7 cm de Ø x 18,4 cm de alto

🍷 1



Tous les prix sont indiqués en P.V.P. unitaire.

Unités de rangement à usage divers



5412CBP

Casier pour unité
de rangement

30,5 x 13 x 11 cm



Couleurs disponibles para soportes: ● 110 ● 480

Couleurs disponibles para recipientes: ● 110 ● 131 ● 401 ● 480



12RS12

Support avec
12 casiers

64,8 x 54,3 x 36,2 cm



9RS9

Support avec 9 casiers

64,8 x 54,3 x 36,2 cm



8RS8

Support avec 8 casiers

64,8 x 48,8 x 24,1 cm



6RS6

Support avec 6 casiers

51,1 x 48,8 x 24,1 cm



Lanternes solaire



SL362

Lanterne solaire

Avec anse - verre et métal
9 x 2 x 2 cm



Tous les articles en **gras** sont des produits de stock habituel. Consulter les couleurs disponibles.



■ Photophores

Nous vous offrons une large gamme de photophores : vintages, colorés ou simples, petits ou grands, parfaits en intérieur comme en extérieur. Certains sont de vraies œuvres d'art qui réussissent à répandre une ambiance chaleureuse et une atmosphère agréable.

HD8

Combustible liquide
pour lampes
38 mm de Ø x 30 mm de haut.
Durée 8 heures

🛒 180



HD12

Combustible liquide
pour lampes
51 mm de Ø x 30 mm de haut.
Durée 12 heures

🛒 144



5151C

Photophore vertical côtés
sculptés pour HD8
8,3 x 7,6 cm - Cristal clair

🛒 1



5151A

Photophore vertical côtés
sculptés pour HD8
8,3 x 7,6 cm - Ambre

🛒 1



1511SC

Photophore vertical avec encastresments
horizontaux pour HD12
10,5 x 7,3 cm - Verre satiné

🛒 1



1511A

Photophore vertical avec encastresments
horizontaux pour HD12
10,5 x 7,3 cm - Ambre

🛒 1



1511C

Photophore vertical avec encastresments
horizontaux pour HD12
10,5 x 7,3 cm - Cristal clair

🛒 1

Tous les prix sont indiqués en P.V.P. unitaire.

■ Photophores (suite)



5140F

Photophore en verre pour HD8
7 cm de Ø x 7,3 cm de haut. - Verre satiné



5140A

Photophore en verre pour HD8
7 cm de Ø x 7,3 cm de haut. - Ambre



5140C

Photophore en verre pour HD8
7 cm de Ø x 7,3 cm de haut. - Cristal clair



5140R

Photophore en verre pour HD8
7 cm de Ø x 7,3 cm de haut. - Rouge



5140CBL

Photophore en verre pour HD8
7 cm de Ø x 7,3 cm de haut. - Bleu



○ Contour



6404AG

Photophore en verre pour HD12
7,6 cm de Ø x 9,4 cm de haut. Or antique



6404CI

Photophore en verre pour HD12
7,6 cm de Ø x 9,4 cm de haut. Glacé clair



6404G

Photophore en verre pour HD12
7,6 cm de Ø x 9,4 cm de haut. Doré



6404R

Photophore en verre pour HD12
7,6 cm de Ø x 9,4 cm de haut. Rouge



○ Data



6005

Photophore en métal pour HD8
6,1 cm de Ø x 8,6 cm de haut. Noir et or



6017

Photophore en métal pour HD12
8 cm de Ø x 10,2 cm de haut. Noir et or



Tous les articles en **gras** sont des produits de stock habituel. Consulter les couleurs disponibles.

■ Photophores (suite)

○ Wysp



44017SC

Photophore cylindre en verre pour HD12
7,3 cm de Ø x 11,4 cm de haut.
Verre satiné



44017CML

Photophore cylindre en verre pour HD12
7,3 cm de Ø x 11,4 cm de haut.
Caramel



44017DB

Photophore cylindre en verre pour HD12
7,3 cm de Ø x 11,4 cm de haut.
Bleu



○ Crackle



43017BP

Photophore cylindre en verre pour HD8
7,9 cm de Ø x 11,4 cm de haut.
Bleu et pourpre



43017G

Photophore cylindre en verre pour HD8
7,9 cm de Ø x 11,4 cm de haut.
Doré



43017

Photophore cylindre en verre pour HD8
7,9 cm de Ø x 11,4 cm de haut.
Rouge et doré



SCH400SL

Photophore vertical pour HD8
7 cm de Ø x 12,1 cm de haut.
Verre satiné



Tous les prix sont indiqués en P.V.P. unitaire.



Lors du stockage des aliments et de la nourriture préparée dans la cuisine, comptez sur le spécialiste mondial dans ce domaine, CAMBRO. Ses solutions, dédiées aux professionnels, sont très appréciées par l'industrie hôtelière. Tenez comptes des aspects suivants :

- Lors de la réception de vos matières premières, transférez le contenu des emballages de votre fournisseur dans vos propres récipients préalablement préparés à cet effet. Evitant ainsi les risques de contamination pendant le transport.
- Les récipients de stockage doivent être hygiéniques, résistants aux bris et aux basses températures et, dans la mesure du possible, transparents pour faciliter l'identification du contenu.
- Les rayonnages des chambres froides doivent être totalement inoxydables, résistants et faciles à nettoyer. Il est souhaitable que les plates-formes pour charges lourdes soient séparées de quelques centimètres du sol pour pouvoir nettoyer en dessous.
- Configurer les rayonnages des chambres de telle sorte que les récipients les plus grands et les plus lourds (tels que les récipients surgelés) soient placés dans les rayons inférieurs et les récipients les plus petits et les moins utilisés soient placés dans les rayons supérieurs. Les rayonnages des chambres frigorifiques doivent être ajourés pour permettre la circulation de l'air dans la chambre, tandis que dans les entrepôts, les produits qui ne sont pas périssables peuvent être rangés sur des étagères pleines.
- Toutes les boîtes de stockage doivent avoir leur propre couvercle pour éviter tout type de contamination.

■ Guide rapide de rayonnage Camshelving



PREMIUM



BASICS

Zone de rangement	Chambres froides avec passages fréquents et avec un grand volume de stockage. Stockage sec d'aliments, de vaisselle, de textile, etc.	Chambres froides avec passage intermittent et avec un volume moyen de stockage. Zones avec espace de stockage d'appoint (zones de passage, bureaux, etc.). Stockage de textile
Usage recommandé	Hôtellerie commerciale Supermarchés Industrie alimentaire Hôpitaux Catering Armée Établissements scolaires et universités	Hôtellerie commerciale Supermarchés Hôpitaux Catering Établissements scolaires et universités
Matériel	Montants et traverses en acier recouvert de polypropylène. Très résistant et durable.	Montants et traverses composite inoxydable léger et extrêmement durable.
Montage	Facile à assembler, les traverses s'emboîtent facilement dans les montants, sans aucun type de visserie.	Montage facile, sans visserie.
Capacité	Unité de base : 200 kg/étagère, 800 kg/unité Unité additionnelle : 340 kg/unité Raccord : 180 kg/ étagère, 720 kg/unité	Unité de base : 150 kg/ étagère, 600 kg/ unité Raccord : 120 kg/ étagère, 480 kg/ unité
Garantie à vie contre la rouille et la corrosion	Étagères Montants Traverses	Étagères Montants Traverses
Longueur de l'unité linéaire (cm)	60, 70, 80, 90, 100, 110, 120, 130, 140, 150, 160, 170	76, 91, 107, 122, 138, 153
Profondeur (cm)	40, 50, 60	46, 54, 61
Hauteurs des montants (cm)	Unité de base : 180 Unité additionnelle : 97 et 179 (roues incluses)	Unité de base : 183 Unité additionnelle : 214 (sur commande)
Unité mobile	OUI	NON
Haute densité	OUI	NON

Tous les prix sont indiqués en P.V.P. unitaire.

■ Configuration des rayonnages Camshelving

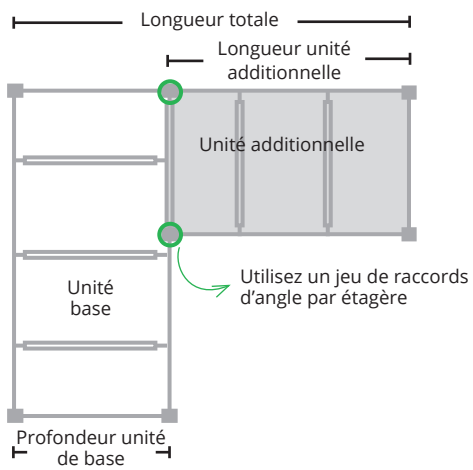
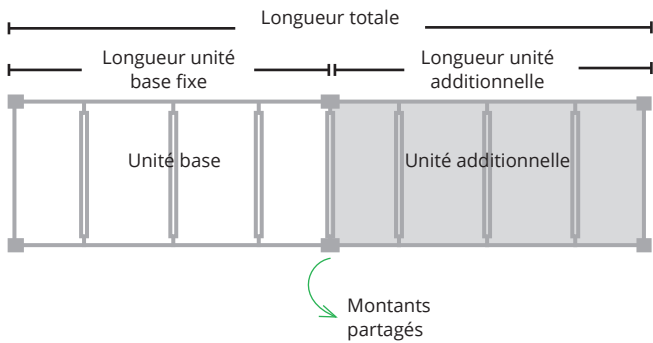

Utilisez un support de rayonnage sous chaque unité de base fixe et additionnelle

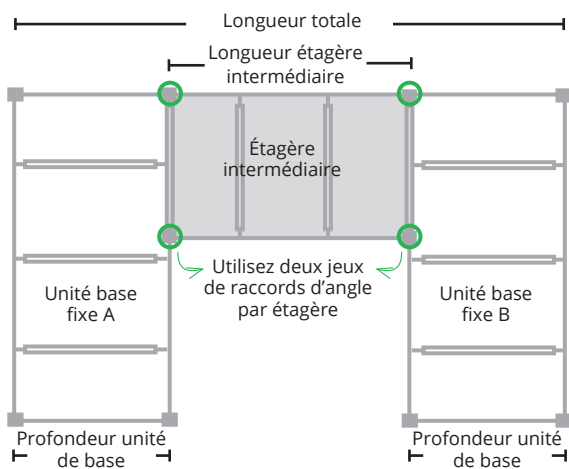

Utilisez quatre supports de rayonnage : un sous chaque unité de base fixe et deux sous l'étagère intermédiaire du bas.

Tous les articles en **gras** sont des produits de stock habituel. Consulter les couleurs disponibles.

SERIE PREMIUM



kg	Certification TÜV capacité de portance		
	Longueur de la traverse (mm)	par étagère	par unité
une seule unité (4 étagères)	600-1200	200 kg	800 kg
	1300-1700	150 kg	600 kg
Support de rayonnage	1300-1700	454 kg	-
Unité d'angle (4 étagères)	600-1200	180 kg	720 kg

CAMGUARD
ANTIMICROBIAL SHELF PLATES

- Premium est un système modulaire qui apporte une flexibilité d'assemblage et s'ajuste à tous les environnements.
 - Facile et rapide à nettoyer
 - Facile à ajuster et à configurer
 - Résistant, stable et durable
 - Résistant à la rouille et à la corrosion
- Les montants et les traverses sont les composants qui supportent les charges lourdes. Ils sont fabriqués avec une structure en acier qui assure la résistance, la durabilité et la stabilité du système Premium.
- Le revêtement externe est en polypropylène. Il ne s'ébrèche pas, ne se casse pas et ne s'oxyde pas.
- Les raccords de montants apportent une stabilité exceptionnelle.
- Le système Premium compte avec la technologie CAMGUARD, qui apporte une protection antimicrobienne intégrée de façon permanente dans les clayettes pour empêcher la prolifération des moisissures, champignons et bactéries.

Tous les prix sont indiqués en P.V.P. unitaire.

Étagère à claire-voie par unité de base

	FOND 40	FOND 50	FOND 60	
Longueur	Code	Code	Code	
60 cm	MPSK4060V1	MPSK5060V1	MPSK6060V1	
70 cm	MPSK4070V1	MPSK5070V1	MPSK6070V1	
80 cm	MPSK4080V1	MPSK5080V1	MPSK6080V1	
90 cm	MPSK4090V1	MPSK5090V1	MPSK6090V1	
100 cm	MPSK40100V1	MPSK50100V1	MPSK60100V1	
110 cm	MPSK40110V1	MPSK50110V1	MPSK60110V1	
120 cm	MPSK40120V1	MPSK50120V1	MPSK60120V1	
130 cm	MPSK40130V1	MPSK50130V1	MPSK60130V1	
140 cm	MPSK40140V1	MPSK50140V1	MPSK60140V1	
150 cm	MPSK40150V1	MPSK50150V1	MPSK60150V1	
160 cm	MPSK40160V1	MPSK50160V1	MPSK60160V1	
170 cm	MPSK40170V1	MPSK50170V1	MPSK60170V1	

Étagère pleine par unité de base

	FOND 40	FOND 50	FOND 60	
Longueur	Code	Code	Code	
60 cm	MPSK4060S1	MPSK5060S1	MPSK6060S1	
70 cm	MPSK4070S1	MPSK5070S1	MPSK6070S1	
80 cm	MPSK4080S1	MPSK5080S1	MPSK6080S1	
90 cm	MPSK4090S1	MPSK5090S1	MPSK6090S1	
100 cm	MPSK40100S1	MPSK50100S1	MPSK60100S1	
110 cm	MPSK40110S1	MPSK50110S1	MPSK60110S1	
120 cm	MPSK40120S1	MPSK50120S1	MPSK60120S1	
130 cm	MPSK40130S1	MPSK50130S1	MPSK60130S1	
140 cm	MPSK40140S1	MPSK50140S1	MPSK60140S1	
150 cm	MPSK40150S1	MPSK50150S1	MPSK60150S1	
160 cm	MPSK40160S1	MPSK50160S1	MPSK60160S1	
170 cm	MPSK40170S1	MPSK50170S1	MPSK60170S1	

Kit de montants pour rayonnage fixe

Code	hauteur (cm)	fond (cm)	U/E
MPPK40180	180	40	1
MPPK50180	180	50	1
MPPK60180	180	60	1

Kit de montants mobiles

Code	hauteur (cm)	fond (cm)	U/E
MPMPK40177	177	40	1
MPMPK50177	177	50	1
MPMPK60177	177	60	1



Tous les articles en **gras** sont des produits de stock habituel. Consulter les couleurs disponibles.



Augmente la capacité de charge jusqu'à 454 kg. Pour unités de 140 cm et plus.

Support de rayonnage

Code	Longueur (cm)	UE
MSDS40	40	1
MSDS50	50	1
MSDS60	60	1



CSEQ3



MSCC

Accessoires variés

Code	Description	UE
MSCC	Jeu de raccords d'angle	1
CSID6	Étiquette d'identification 152 mm	12
CSEQ3	Pieds anti-séisme	4
CSWF	Fixation murale	4



CSWF



CSID



Barre de séparation des étagères - pour étagères de 60 cm de prof.

Code	Description	UE
CSSD248	61 x 20 cm	1



Barres de séparation des étagères - pour étagères de 60 cm de prof.

Code	Description	UE
CSDBA	Barre d'angle	1
CSDBS	Barre droite	1

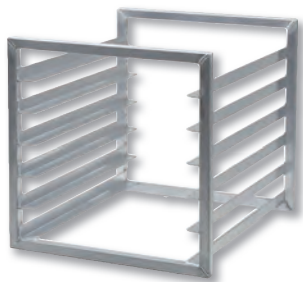

Casier à coulisses pour plateaux - pour étagères de 60 cm de prof.

Code	Description	UE
CSTSR	52,7 x 59 x 51,4 cm	1

Conçu pour 6 plateaux de 46 x 66 cm, pour des unités de 60 cm de profondeur et 60 cm ou plus de longueur.

Tous les prix sont indiqués en P.V.P. unitaire.



Rayonnage PREMIUM - Chariots



MPMU61317DRPKG



MPMU61217PDPKG

Chariot de séchage et de rangement

Code	Description	UE
MPMU61117DRPKG	Chariot vertical - 60 x 118 x 179 cm - 84 plateaux	1
MPMU61317DRPKG	Chariot vertical - 60 x 138 x 179 cm - 105 plateaux	1
MPMU61217PDPKG	Carro incliné - 60 x 128 x 179 cm - 128 plaques et bases ou 16 bacs GN1/1	1

Étagère de séchage

Code	Description	UE
CSDR7	Séchage vertical - 59,7 x 26 x 9,5 cm - pour fond de 60 cm	1
CSDR8	Séchage incliné - 59,2 x 26,3 x 16 cm - pour fond de 60 cm	1
CSDDC	Séchage pour dômes - 41,4 x 52 x 8,59 cm - pour 10 dômes	1

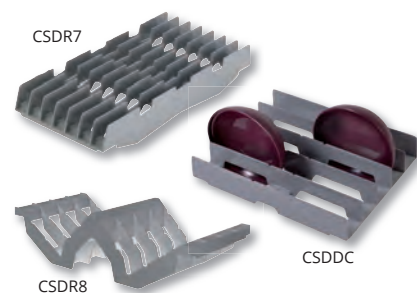

Tous les articles en **gras** sont des produits de stock habituel. Consulter les couleurs disponibles.

Rayonnage PREMIUM - Cages de sécurité



CSSC244818



CPMU244867SUPKG

Cage de sécurité enveloppante – uniquement pour étagères de 60 cm de prof.

Code	Description	UE
CPU244864SUPKG	Cage de sécurité pour unité fixe - 68 x 127,6 x 163,8 cm	1
CPMU244867SUPKG	Cage de sécurité pour unité mobile - 68 x 127,6 x 172,1 cm	1
CSSC244818	Cage de sécurité petite - 64 x 108 x 46 cm	1

Service conseil en rayonnage

1. fournissez-nous les dimensions de la zone où vous voulez placer les rayonnages. Indiquez-nous vos besoins : nombre d'étagères par unité, hauteur des montants, etc.
2. Le Service Conseil de DBMARK vous fournira un plan avec la configuration recommandée pour votre zone de stockage ainsi que la liste détaillée des produits.
3. Nous vous mettons en contact avec un de nos distributeurs ou commerciaux qui pourra vous fournir le devis correspondant à la configuration recommandée.



DBMARK vous offre un service conseil gratuit pour vous aider à optimiser l'utilisation de votre espace et créer le maximum de possibilités de stockage.

Contactez le Service Conseil en rayonnage :

- Par téléphone au 01 86 26 67
- Par courrier électronique à mchacon@dbmark.com

Tous les prix sont indiqués en P.V.P. unitaire.



Unité de base avec 4 étagères à claire-voie - 180 cm hauteur

	FOND 40	FOND 50	FOND 60
Longueur	Code	Code	Code
68 cm	MPU4618V4PKG	MPU5618V4PKG	MPU6618V4PKG
78 cm	MPU4718V4PKG	MPU5718V4PKG	MPU6718V4PKG
88 cm	MPU4818V4PKG	MPU5818V4PKG	MPU6818V4PKG
98 cm	MPU4918V4PKG	MPU5918V4PKG	MPU6918V4PKG
108 cm	MPU41018V4PKG	MPU51018V4PKG	MPU61018V4PKG
118 cm	MPU41118V4PKG	MPU51118V4PKG	MPU61118V4PKG
128 cm	MPU41218V4PKG	MPU51218V4PKG	MPU61218V4PKG
138 cm	MPU41318V4PKG	MPU51318V4PKG	MPU61318V4PKG
148 cm	MPU41418V4PKG	MPU51418V4PKG	MPU61418V4PKG
158 cm	MPU41518V4PKG	MPU51518V4PKG	MPU61518V4PKG
168 cm	MPU41618V4PKG	MPU51618V4PKG	MPU61618V4PKG
178 cm	MPU41718V4PKG	MPU51718V4PKG	MPU61718V4PKG



Pour des longueurs supérieures voir page 227.

Unité additionnelle avec 4 étagères à claire-voie- 180 cm hauteur

	FOND 40	FOND 50	FOND 60
Longueur	Code	Code	Code
64 cm	MPA4618V4PKG	MPA5618V4PKG	MPA6618V4PKG
74 cm	MPA4718V4PKG	MPA5718V4PKG	MPA6718V4PKG
84 cm	MPA4818V4PKG	MPA5818V4PKG	MPA6818V4PKG
94 cm	MPA4918V4PKG	MPA5918V4PKG	MPA6918V4PKG
104 cm	MPA41018V4PKG	MPA51018V4PKG	MPA61018V4PKG
114 cm	MPA41118V4PKG	MPA51118V4PKG	MPA61118V4PKG
124 cm	MPA41218V4PKG	MPA51218V4PKG	MPA61218V4PKG
134 cm	MPA41318V4PKG	MPA51318V4PKG	MPA61318V4PKG
144 cm	MPA41418V4PKG	MPA51418V4PKG	MPA61418V4PKG
154 cm	MPA41518V4PKG	MPA51518V4PKG	MPA61518V4PKG
164 cm	MPA41618V4PKG	MPA51618V4PKG	MPA61618V4PKG
174 cm	MPA41718V4PKG	MPA51718V4PKG	MPA61718V4PKG



Tous les articles en **gras** sont des produits de stock habituel. Consulter les couleurs disponibles.



Unité de base avec 4 étagères pleines - 180 cm hauteur

	FOND 40	FOND 50	FOND 60
Longueur	Code	Code	Code
68 cm	MPU4618S4PKG	MPU5618S4PKG	MPU6618S4PKG
78 cm	MPU4718S4PKG	MPU5718S4PKG	MPU6718S4PKG
88 cm	MPU4818S4PKG	MPU5818S4PKG	MPU6818S4PKG
98 cm	MPU4918S4PKG	MPU5918S4PKG	MPU6918S4PKG
108 cm	MPU41018S4PKG	MPU51018S4PKG	MPU61018S4PKG
118 cm	MPU41118S4PKG	MPU51118S4PKG	MPU61118S4PKG
128 cm	MPU41218S4PKG	MPU51218S4PKG	MPU61218S4PKG
138 cm	MPU41318S4PKG	MPU51318S4PKG	MPU61318S4PKG
148 cm	MPU41418S4PKG	MPU51418S4PKG	MPU61418S4PKG
158 cm	MPU41518S4PKG	MPU51518S4PKG	MPU61518S4PKG
168 cm	MPU41618S4PKG	MPU51618S4PKG	MPU61618S4PKG
178 cm	MPU41718S4PKG	MPU51718S4PKG	MPU61718S4PKG



Pour des longueurs supérieures voir page 228.

Unité additionnelle avec 4 étagères pleines - 180 cm hauteur

	FOND 40	FOND 50	FOND 60
Longueur	Code	Code	Code
64 cm	MPA4618S4PKG	MPA5618S4PKG	MPA6618S4PKG
74 cm	MPA4718S4PKG	MPA5718S4PKG	MPA6718S4PKG
84 cm	MPA4818S4PKG	MPA5818S4PKG	MPA6818S4PKG
94 cm	MPA4918S4PKG	MPA5918S4PKG	MPA6918S4PKG
104 cm	MPA41018S4PKG	MPA51018S4PKG	MPA61018S4PKG
114 cm	MPA41118S4PKG	MPA51118S4PKG	MPA61118S4PKG
124 cm	MPA41218S4PKG	MPA51218S4PKG	MPA61218S4PKG
134 cm	MPA41318S4PKG	MPA51318S4PKG	MPA61318S4PKG
144 cm	MPA41418S4PKG	MPA51418S4PKG	MPA61418S4PKG
154 cm	MPA41518S4PKG	MPA51518S4PKG	MPA61518S4PKG
164 cm	MPA41618S4PKG	MPA51618S4PKG	MPA61618S4PKG
174 cm	MPA41718S4PKG	MPA51718S4PKG	MPA61718S4PKG



Tous les prix sont indiqués en P.V.P. unitaire.

Modules fixes- Hauteur 180 cm - 4 étagères à claire-voie

LONGUEUR	MODULES	FOND 40	FOND 50	FOND 60
192 cm	100 + 80	MPU41018V4PKG + MPA4818V4PKG	MPU51018V4PKG + MPA5818V4PKG	MPU61018V4PKG + MPA6818V4PKG
202 cm	110 + 80	MPU41118V4PKG + MPA4818V4PKG	MPU51118V4PKG + MPA5818V4PKG	MPU61118V4PKG + MPA6818V4PKG
212 cm	120 + 80	MPU41218V4PKG + MPA4818V4PKG	MPU51218V4PKG + MPA5818V4PKG	MPU61218V4PKG + MPA6818V4PKG
222 cm	110 + 100	MPU41118V4PKG + MPA41018V4PKG	MPU51118V4PKG + MPA51018V4PKG	MPU61118V4PKG + MPA61018V4PKG
232 cm	120 + 100	MPU41218V4PKG + MPA41018V4PKG	MPU51218V4PKG + MPA51018V4PKG	MPU61218V4PKG + MPA61018V4PKG
242 cm	120 + 110	MPU41218V4PKG + MPA41118V4PKG	MPU51218V4PKG + MPA51118V4PKG	MPU61218V4PKG + MPA61118V4PKG
252 cm	120 + 120	MPU41218V4PKG + MPA41218V4PKG	MPU51218V4PKG + MPA51218V4PKG	MPU61218V4PKG + MPA61218V4PKG
262 cm	130 + 120	MPU41318V4PKG + MPA41218V4PKG	MPU51318V4PKG + MPA51218V4PKG	MPU61318V4PKG + MPA61218V4PKG
272 cm	150 + 110	MPU41518V4PKG + MPA41118V4PKG	MPU51518V4PKG + MPA51118V4PKG	MPU61518V4PKG + MPA61118V4PKG
282 cm	150 + 120	MPU41518V4PKG + MPA41218V4PKG	MPU51518V4PKG + MPA51218V4PKG	MPU61518V4PKG + MPA61218V4PKG
292 cm	160 + 120	MPU41618V4PKG + MPA41218V4PKG	MPU51618V4PKG + MPA51218V4PKG	MPU61618V4PKG + MPA61218V4PKG
302 cm	160 + 130	MPU41618V4PKG + MPA41318V4PKG	MPU51618V4PKG + MPA51318V4PKG	MPU61618V4PKG + MPA61318V4PKG
312 cm	150 + 150	MPU41518V4PKG + MPA41518V4PKG	MPU51518V4PKG + MPA51518V4PKG	MPU61518V4PKG + MPA61518V4PKG
322 cm	160 + 150	MPU41618V4PKG + MPA41518V4PKG	MPU51618V4PKG + MPA51518V4PKG	MPU61618V4PKG + MPA61518V4PKG
332 cm	160 + 160	MPU41618V4PKG + MPA41618V4PKG	MPU51618V4PKG + MPA51618V4PKG	MPU61618V4PKG + MPA61618V4PKG
342 cm	170 + 160	MPU41718V4PKG + MPA41618V4PKG	MPU51718V4PKG + MPA51618V4PKG	MPU61718V4PKG + MPA61618V4PKG
352 cm	170 + 170	MPU41718V4PKG + MPA41718V4PKG	MPU51718V4PKG + MPA51718V4PKG	MPU61718V4PKG + MPA51718V4PKG



Premium est un système modulaire qui offre une flexibilité de montage et s'adapte à toutes les dimensions.

Les composants essentiels, montants, raccords de montant, traverses et clayettes sont disponibles en différentes tailles.

Facilement configurables pour construire un rayonnage à votre goût et pour tirer le meilleur parti de votre espace de stockage.

Ses éléments de conception unique, comme les kits de montants (prémontés) et les raccords d'angle, simplifient le montage et augmentent la capacité de stockage.



Les composants qui supportent la charge sont constitués d'acier recouvert en polypropylène

Tous les articles en **gras** sont des produits de stock habituel. Consulter les couleurs disponibles.

Modules fixes- Hauteur 180 cm - 4 étagères pleines

LONGUEUR	MODULES	FOND 40	FOND 50	FOND 60
192 cm	100 + 80	MPU41018S4PKG + MPA4818S4PKG	MPU51018S4PKG + MPA5818S4PKG	MPU61018S4PKG + MPA6818S4PKG
202 cm	110 + 80	MPU41118S4PKG + MPA4818S4PKG	MPU51118S4PKG + MPA5818S4PKG	MPU61118S4PKG + MPA6818S4PKG
212 cm	120 + 80	MPU41218S4PKG + MPA4818S4PKG	MPU51218S4PKG + MPA5818S4PKG	MPU61218S4PKG + MPA6818S4PKG
222 cm	110 + 100	MPU41118S4PKG + MPA41018S4PKG	MPU51118S4PKG + MPA51018S4PKG	MPU61118S4PKG + MPA61018S4PKG
232 cm	120 + 100	MPU41218S4PKG + MPA41018S4PKG	MPU51218S4PKG + MPA51018S4PKG	MPU61218S4PKG + MPA61018S4PKG
242 cm	120 + 110	MPU41218S4PKG + MPA41118S4PKG	MPU51218S4PKG + MPA51118S4PKG	MPU61218S4PKG + MPA61118S4PKG
252 cm	120 + 120	MPU41218S4PKG + MPA41218S4PKG	MPU51218S4PKG + MPA51218S4PKG	MPU61218S4PKG + MPA61218S4PKG
262 cm	130 + 120	MPU41318S4PKG + MPA41218S4PKG	MPU51318S4PKG + MPA51218S4PKG	MPU61318S4PKG + MPA61218S4PKG
272 cm	150 + 110	MPU41518S4PKG + MPA41118S4PKG	MPU51518S4PKG + MPA51118S4PKG	MPU61518S4PKG + MPA61118S4PKG
282 cm	150 + 120	MPU41518S4PKG + MPA41218S4PKG	MPU51518S4PKG + MPA51218S4PKG	MPU61518S4PKG + MPA61218S4PKG
292 cm	160 + 120	MPU41618S4PKG + MPA41218S4PKG	MPU51618S4PKG + MPA51218S4PKG	MPU61618S4PKG + MPA61218S4PKG
302 cm	160 + 130	MPU41618S4PKG + MPA41318S4PKG	MPU51618S4PKG + MPA51318S4PKG	MPU61618S4PKG + MPA61318S4PKG
312 cm	150 + 150	MPU41518S4PKG + MPA41518S4PKG	MPU51518S4PKG + MPA51518S4PKG	MPU61518S4PKG + MPA61518S4PKG
322 cm	160 + 150	MPU41618S4PKG + MPA41518S4PKG	MPU51618S4PKG + MPA51518S4PKG	MPU61618S4PKG + MPA61518S4PKG
332 cm	160 + 160	MPU41618S4PKG + MPA41618S4PKG	MPU51618S4PKG + MPA51618S4PKG	MPU61618S4PKG + MPA61618S4PKG
342 cm	170 + 160	MPU41718S4PKG + MPA41618S4PKG	MPU51718S4PKG + MPA51618S4PKG	MPU61718S4PKG + MPA61618S4PKG
352 cm	170 + 170	MPU41718S4PKG + MPA41718S4PKG	MPU51718S4PKG + MPA51718S4PKG	MPU61718S4PKG + MPA51718S4PKG

Kits de rayonnage mobile à claire-voie - Hauteur 177 cm / 4 étages

Longueur	FOND 40	Fond 50	Fond 60
	Code	Code	Code
68 cm	MPMU4617V4PKG	MPMU5617V4PKG	MPMU6617V4PKG
78 cm	MPMU4717V4PKG	MPMU5717V4PKG	MPMU6717V4PKG
88 cm	MPMU4817V4PKG	MPMU5817V4PKG	MPMU6817V4PKG
98 cm	MPMU4917V4PKG	MPMU5917V4PKG	MPMU6917V4PKG
108 cm	MPMU41017V4PKG	MPMU51017V4PKG	MPMU61017V4PKG
118 cm	MPMU41117V4PKG	MPMU51117V4PKG	MPMU61117V4PKG
128 cm	MPMU41217V4PKG	MPMU51217V4PKG	MPMU61217V4PKG
138 cm	MPMU41317V4PKG	MPMU51317V4PKG	MPMU61317V4PKG
148 cm	MPMU41417V4PKG	MPMU51417V4PKG	MPMU61417V4PKG
158 cm	MPMU41517V4PKG	MPMU51517V4PKG	MPMU61517V4PKG
168 cm	MPMU41617V4PKG	MPMU51617V4PKG	MPMU61617V4PKG
178 cm	MPMU41717V4PKG	MPMU51717V4PKG	MPMU61717V4PKG



Tous les prix sont indiqués en P.V.P. unitaire.



Station Flex Série Premium

Cette unité multi-usage peut répondre à différents besoins et peut servir de station Grab and Go, à la vente de produits ou de station de livraison, de rangement d'ustensiles et bien plus encore.

La station comprend : 2 kits de montants mobiles préassemblés, 8 traverses, 36 barres de séparation inclinées (4 supplémentaires), 4 roulettes à blocage total et 24 étiquettes d'identification. Montage nécessaire. Bacs GN et autres accessoires vendus séparément.

Code	Description	Dimensions (mm)	UE
CPMU244867FXPKG	Station Flex Série Premium	610 x 1220 x 1778 mm	1
CSDBA	Barres de séparation inclinées	610 mm	4
CSID6	Étiquettes d'identification	25 x 152 mm	12



Tous les articles en **gras** sont des produits de stock habituel. Consulter les couleurs disponibles.

Unité Espace Plus

Le système Espace Plus Premium augmente la capacité de stockage en créant des allées de stockage dans tous les espaces disponibles. Le système de rails permet un accès facile et sûr aux produits stockés. Les unités mobiles haute densité Premium augmentent la capacité de stockage jusqu'à 50%.

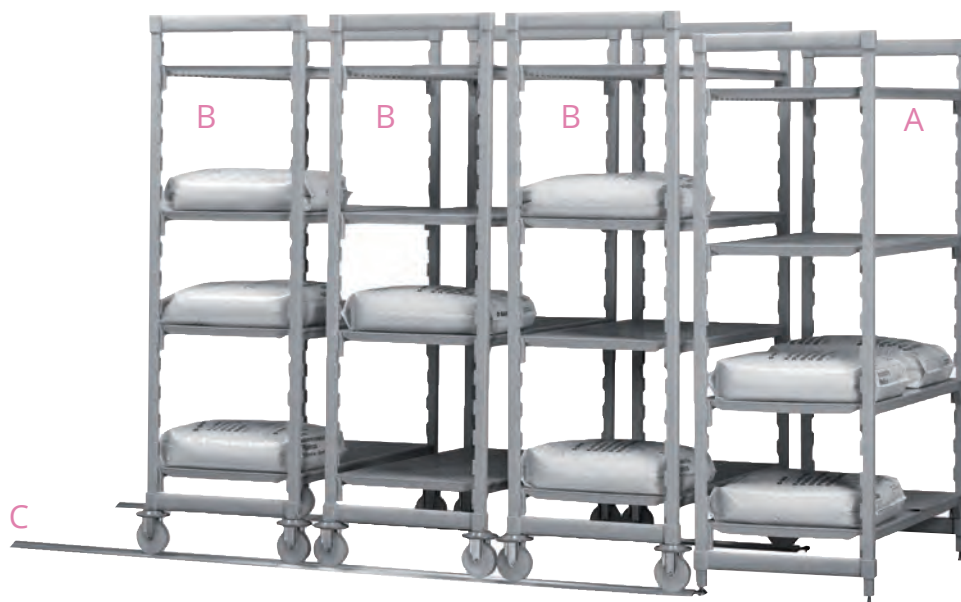

A Rayonnage à claire-voie fixe - 4 étagères

Code	L (cm)	f (cm)	h (cm)	UE
MPU6918V4PKG	98	60	180	1
MPU61018V4PKG	108	60	180	1
MPU61118V4PKG	118	60	180	1
MPU61218V4PKG	128	60	180	1

B Rayonnage à claire-voie mobile sur rails - 4 étagères

Code	L (cm)	f (cm)	h (cm)	UE
MSHD46917PK	90	60	180	1
MSHD461017PK	100	60	180	1
MSHD461117PK	110	60	180	1
MSHD461217PK	120	60	180	1

C Jeu de 2 rails pour rayonnage à claire-voie

Code	Description	L (cm)	UE
CSHDTK10	Pour 3 un. mobiles et 2 fixes	305	1
CSHDTK12	Pour 4 un. mobiles et 2 fixes	366	1
CSHDTK145	Pour 5 un. mobiles et 2 fixes	442	1

Etagère murale

Code	Description	L (cm)	h (cm)	UE
CSWS1836SK	Pleine	91	45	1
CSWS1848SK	Pleine	122	45	1
CSWS1436SK	Pleine	91	36	1
CSWS1448SK	Pleine	122	36	1
CSWS1436VK	À claire-voie	91	36	1
CSWS1448VK	À claire-voie	122	36	1



Unité additionnelle d'étagère

Code	Description	L (cm)	h (cm)	UE
CSWS36EK	Unité additionnelle 91 cm	91	36	1
CSWS48EK	Unité additionnelle 122 cm	122	36	1



Tous les prix sont indiqués en P.V.P. unitaire.



Casiers à glissières pour rayonnage

Produit léger et durable, doté d'une garantie à vie contre la rouille et la corrosion. Ce module est conçu pour s'adapter facilement et solidement sur une étagère.

- Maximise l'espace de rangement en chambres froides et/ou dans les espaces de préparation.
- À utiliser pour décongeler, préparer, maintenir ou refroidir les produits alimentaires.
- Peut contenir 6 plaques de 60 x 40 cm dans un espace compact.
- Conçu pour s'adapter parfaitement sur les étagères Premium et Basics (60 cm de profondeur).

Casier à glissières de 60 x 40 cm

Code	Description	Dimensions (cm)	UE
CSUPR6040S6	S'adapte à Camshelving MP Premium, CP Premium	46,5 x 61,2 x 51,4 cm	1
CBUPR6040S6	S'adapte à la série Camshelving Basics Plus	46,5 x 61,2 x 51,4 cm	1



Casier à glissières de 66 x 46 cm

Code	Description	Dimensions (cm)	UE
CSUPR1826S6	S'adapte à Camshelving MP Premium, CP Premium	52 x 61,2 x 51,4 cm	1
CBUPR1826S6	S'adapte à la série Camshelving Basics Plus	52 x 61,2 x 51,4 cm	1



Tous les articles en **gras** sont des produits de stock habituel. Consulter les couleurs disponibles.

SERIE BASICS



kg	longueur de la traverse (mm)	Certification TÜV Capacité de portance	
		par étagère	par unité
une seule unité (4 étagères)	760-910	150 kg	600 kg
	1070-1220	150 kg	600 kg
	1380-1530	130 kg	520 kg
Support de rayonnage	1380-1530	360 kg	-
Unité d'angle (4 étagères)	760-1220	120 kg	480 kg



- Matériaux avancés et design innovant, la série BASICS offre : une grande fiabilité, confort, flexibilité, et une plus grande efficacité au travail et alimentaire.
- La série BASICS définit une nouvelle catégorie complète de rayonnages CAMBRO qui fournira aux opérateurs des solutions de stockage solides et sûres, d'une manière beaucoup plus économique qu'auparavant.
- Peu importe l'espace disponible, que ce soit dans une chambre froide, un entrepôt, une installation sanitaire, etc. Le système BASICS est conçu avec une flexibilité qui s'adapte à n'importe quel espace. Vous pouvez concevoir une configuration qui correspond à vos besoins de stockage, même dans les espaces les plus réduits.
- Le matériau léger, extrêmement durable et anti-corrosion qui compose les produits de Camshelving Basics, résiste même dans les environnements les plus difficiles, et est conforme aux recommandations sanitaires HACCP et de sécurité alimentaire.
- Ni l'eau, ni l'humidité ne corrodent Camshelving Basics. Résistant aux rayures, aux déformations, à l'oxydation et à la corrosion, chaque composant a été rigoureusement testé pour évaluer sa résistance, sa fiabilité et ses performances.
- Légères mais extrêmement durables. Avec un prix très économique, similaire à celui d'autres systèmes de rayonnages en aluminium, mais avec la garantie et la qualité de **CAMBRO**.
- Résistent jusqu'à -38 °C, ce qui les rend parfaits pour la congélation.
- Contribuent à la préservation de l'environnement et vous aideront dans vos politiques environnementales, car c'est un rayonnage à vie et d'un matériau composite recyclable.

Tous les prix sont indiqués en P.V.P. unitaire.

Rayonnage BASICS - Composants

Étagère à claire-voie pour unité de base



Hauteur de 214 cm disponible sur commande

L (cm)	Fond 46	Fond 54	Fond 61
	Code	Code	Code
85 cm	CBSK1836V1	CBSK2136V1	CBSK2436V1
101 cm	CBSK1842V1	CBSK2142V1	CBSK2442V1
116 cm	CBSK1848V1	CBSK2148V1	CBSK2448V1
132 cm	CBSK1854V1	CBSK2154V1	CBSK2454V1
147 cm	CBSK1860V1	CBSK2160V1	CBSK2460V1

Kit de montants fixes 183 cm hauteur

Code	Description	UE
CBPK1872	183 x 46 cm	1
CBPK2172	183 x 54 cm	1
CBPK2472	183 x 61 cm	1

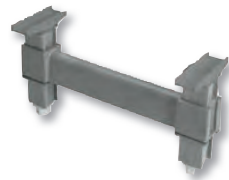

Support de rayonnage

Code	Description	UE
CBDS18	46 cm	1
CBDS21	54 cm	1
CBDS24	61 cm	1



CBID6



CSWF



CBCC



CSEQ3

Accessoires

Code	Description	UE
CBCC	Jeu de raccord d'angle	1
CBID6	Étiquettes d'identification de 152 mm	12
CSEQ3	Pied anti-séisme	4
CSWF	Fixation murale	4



Tous les articles en **gras** sont des produits de stock habituel. Consulter les couleurs disponibles.

Unités sous-plan de travail

Ces rayonnages offrent un espace de stockage sous les comptoirs, plan de travail ou sous les tables, tout en maintenant les articles à portée de main du personnel. Idéal pour ranger condiments, serviettes, divers ustensiles, les contenants de vente à emporter et autres articles nécessitant un accès rapide et facile.

Unité sous-plan mobile

Code	Dimensions (cm)	UE
EMU142427V2	36 x 61 x 68,5 cm	1
EMU143627V2	36 x 91,5 x 68,5 cm	1
EMU144827V2	36 x 122 x 68,5 cm	1

Unité sous-plan fixe

Code	Dimensions (cm)	UE
ESU183630V2	46 x 91,5 x 76,5 cm	1
ESU184830V2	36 x 91,5 x 68,5 cm	1

Jeu de montants - fixe

Code	Dimensions (cm)	UE
EPK1830	46 x 76,5 cm	1

Couleur disponible : graphite brossé



Rayonnage BASICS - Modules complets

Unité de base à 4 étagères à claire-voie- 183 cm hauteur

L (cm)	Fond 46		Fond 54		Fond 61	
	Code		Code		Code	
91 cm	CBU183672V4		CBU213672V4		CBU243672V4	
107 cm	CBU184272V4		CBU214272V4		CBU244272V4	
122 cm	CBU184872V4		CBU214872V4		CBU244872V4	
138 cm	CBU185472V4		CBU215472V4		CBU245472V4	
153 cm	CBU186072V4		CBU216072V4		CBU246072V4	



Pour des longueurs supérieures voir page 237

Unité additionnelle à 4 étagères à claire-voie- 183 cm hauteur

L (cm)	Fond 46		Fond 54		Fond 61	
	Code		Code		Code	
87 cm	CBA183672V4		CBA213672V4		CBA243672V4	
103 cm	CBA184272V4		CBA214272V4		CBA244272V4	
118 cm	CBA184872V4		CBA214872V4		CBA244872V4	
134 cm	CBA185472V4		CBA215472V4		CBA245472V4	
149 cm	CBA186072V4		CBA216072V4		CBA246072V4	



Tous les prix sont indiqués en P.V.P. unitaire.

Modules - Hauteur 183 cm - 4 étagères à claire-voie
(Hauteur de 214 cm disponible sur commande)

LONGUEUR	MODULES	FOND 46	FOND 54	FOND 61
179 cm	85 + 85	CBU183672V4 + CBA183672V4	CBU213672V4 + CBA213672V4	CBU243672V4 + CBA243672V4
195 cm	85 + 101	CBU183672V4 + CBA184272V4	CBU213672V4 + CBA214272V4	CBU243672V4 + CBA244272V4
210 cm	85 + 116	CBU183672V4 + CBA184872V4	CBU213672V4 + CBA214872V4	CBU243672V4 + CBA244872V4
226 cm	101 + 116	CBU184272V4 + CBA184872V4	CBU214272V4 + CBA214872V4	CBU244272V4 + CBA244872V4
241 cm	116 + 116	CBU184872V4 + CBA184872V4	CBU214872V4 + CBA214872V4	CBU244872V4 + CBA244872V4
257 cm	116 + 132	CBU184872V4 + CBA185472V4	CBU214872V4 + CBA215472V4	CBU244872V4 + CBA245472V4
272 cm	116 + 147	CBU184872V4 + CBA186072V4	CBU214872V4 + CBA216072V4	CBU244872V4 + CBA246072V4
288 cm	132 + 147	CBU185472V4 + CBA186072V4	CBU215472V4 + CBA216072V4	CBU245472V4 + CBA246072V4
303 cm	147 + 147	CBU186072V4 + CBA186072V4	CBU216072V4 + CBA216072V4	CBU246072V4 + CBA246072V4

Peu importe l'espace disponible, que ce soit dans une chambre froide, un entrepôt, une installation sanitaire, etc. le Système Camshelving BASICS est conçu avec une flexibilité qui s'adapte à n'importe quel espace.

Vous pouvez concevoir une configuration qui correspond à vos besoins de stockage, même dans les espaces les plus réduits.



Le matériau léger, extrêmement durable et non corrosif qui compose les produits de Camshelving Basics, supporte même les environnements les plus extrêmes, et est conforme aux recommandations sanitaires HACCP et aux normes de sécurité alimentaire.

Ni l'eau ni la brise marine ne corrompent Camshelving Basics.

Résistant aux rayures, aux déformations, à l'oxydation et à la corrosion, tous les composants ont été rigoureusement testés pour évaluer leur résistance, leur fiabilité et leur rendement.

Tous les articles en **gras** sont des produits de stock habituel. Consulter les couleurs disponibles.

■ Palettes de stockage

Palettes de stockage supportent jusqu'à 1.360kg. Elles assurent une hygiène parfaite des produits congelés, froids ou secs en les stockant à 30,5 cm au-dessus du sol. Disponibles en différentes longueurs (largeur unique de 52 cm). Spécialement indiqués pour le stockage de sacs de pommes de terre, de conserves ou des bricks de lait.

Palette de stockage à surface pleine

Code	Description	Couleurs	UE
DRS30	30 x 52 x 76 cm	480	1
DRS36	30 x 52 x 91,5 cm	480	1
DRS48	30 x 52 x 122 cm	480	1
DRS60	30 x 52 x 152 cm	480	1

Palette de stockage à surface à clayette

Code	Description	Couleurs	UE
DRS300	30 x 52 x 76 cm	480	1
DRS360	30 x 52 x 91,5 cm	480	1
DRS480	30 x 52 x 122 cm	480	1
DRS600	30 x 52 x 152 cm	480	1

Accessoires

Code	Description	UE
DRLNK	Raccord Camlink	1



■ Boîtes à pâte à pizza

Les boîtes de pâte à pizza blanches évitent la pénétration de la lumière à l'intérieur de la boîte, de sorte que la pâte à pizza ne soit pas endommagée. Elles sont empilables et résistantes.

Boîte à pâte à pizza

Code	Description	Couleurs	UE
DB18263CW	46 x 66 x 7,6 cm - polycarbonate	148	6
DB18266CW	46 x 66 x 15 cm - polycarbonate	148	6
DB18263P	46 x 66 x 7,6 cm - polipropileno	148	6
CD1826PDB	Chariot pour boîte à pizza	110 131 157 401	1

Couvercle pour boîte à pizza

Code	Description	Couleurs	UE
DBC1826CW	Polycarbonate	148	6
DBC1826P	Polipropileno	148	6



Nouveauté

Boîte à pâtons en polyéthylène

Code	Description	Couleurs	UE
DB60407	60 x 40 x 7 cm - polyéthylène. Profondeur : 6,5 cm	148	1
DB604010	60 x 40 x 10 cm - polyéthylène. Profondeur : 9,5 cm	148	1

Couvercle pour boîte à pâtons

Code	Description	Couleurs	UE
DB6040C	Couvercle en polypropylène	148	1



Tous les prix sont indiqués en P.V.P. unitaire.

Bacs à ingrédients

Les bacs à ingrédients sont le choix idéal pour stocker des produits en vrac comme le sucre, les légumes ou les farines. Ils ont tous un couvercle en polycarbonate, ils roulent facilement et peuvent être placés sous les plans de travail. Le bac à ingrédient CC32 dispose d'un robinet de drainage pour faciliter le lavage des légumes. Choisissez la taille la plus appropriée en fonction de vos besoins.

Consulter les pièces de rechange pour ces articles dans le chapitre **PIÈCES DE RECHANGES**



IB36

IB32

CC32

Bac à ingrédient avec couvercle plat

Code	Description	UE
IBSF27	33 x 76,5 x 72,5 cm - 102 L	1
IB32	56 x 61 x 58,5 cm - 121 L	1
IB36	39 x 75 x 74 cm - 129 L	1
IB44	47 x 75 x 74 cm - 161 L	1
CC32	Avec robinet - 56 x 61 x 58,5 cm - 121 L	1



IBS20

IBS27

IBS37

Bacs à ingrédient avec couvercle incliné

Code	Description	UE
IBS20	33 x 75 x 71 cm - 81 L	1
IBS27	42 x 75 x 71 cm - 102 L	1
IBS37	55 x 75 x 71 cm - 140 L	1



Conteneurs à ingrédients sans couvercle*

Code	Description	Couleurs	UE
RC-2003	Conteneur de 85 L	<input type="checkbox"/> <input type="checkbox"/> <input type="checkbox"/> <input type="checkbox"/> <input type="checkbox"/> <input type="checkbox"/> <input type="checkbox"/> <input type="checkbox"/>	1
RC-2005	Conteneur de 120 L	<input type="checkbox"/> <input type="checkbox"/> <input type="checkbox"/> <input type="checkbox"/> <input type="checkbox"/> <input type="checkbox"/>	1

* conteneurs et couvercles noir et vert non approuvés pour le contact alimentaire

Couvercle*

Code	Description	Couleurs	UE
RC-2013	Couvercle à conteneur de 85 L	<input type="checkbox"/> <input type="checkbox"/> <input type="checkbox"/> <input type="checkbox"/> <input type="checkbox"/> <input type="checkbox"/> <input type="checkbox"/> <input type="checkbox"/>	1
RC-2015	Couvercle à conteneur de 120 L	<input type="checkbox"/> <input type="checkbox"/> <input type="checkbox"/> <input type="checkbox"/> <input type="checkbox"/> <input type="checkbox"/>	1

* conteneurs et couvercles noir et vert non approuvés pour le contact alimentaire



Chariot ajustable

Code	Description	UE
RC-2092	Pour RC-2003 et RC-2005	1

Rejoignez-nous



@DbmarkTweet



@dbmarkhosteleria



@dbmark_inst

Tous les articles en **gras** sont des produits de stock habituel. Consulter les couleurs disponibles.

Boîtes rondes

Les récipients ronds de CAMBRO sont le choix parfait pour le stockage de liquides. Ils sont disponibles en 3 matériaux différents : polycarbonate transparent incassable, polyéthylène blanc et polypropylène translucide. Tous les récipients portent des mesures métriques et impériales.

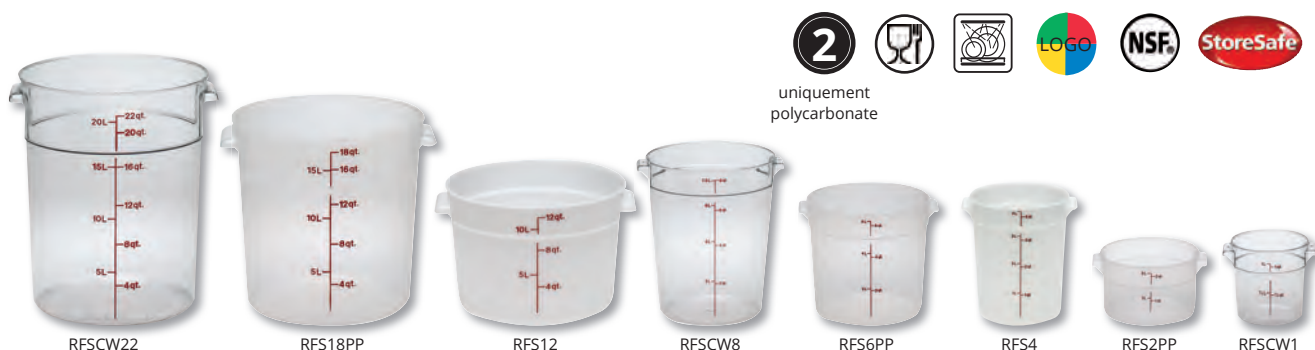

Boîte ronde

Dimensions	Capacité	Polycarbonate		Polypropylène		Polyéthylène		UE
		Code	Code	Code	Code			
15,4 cm Ø x 12,7 cm haut.	0,9 L	RFSCW1	RFS1PP	RFS1				12
20,8 cm Ø x 11,1 cm haut.	1,9 L	RFSCW2	RFS2PP	RFS2				12
20,8 cm Ø x 21,8 cm haut.	3,8 L	RFSCW4	RFS4PP	RFS4				12
25,2 cm Ø x 20,2 cm haut.	5,7 L	RFSCW6	RFS6PP	RFS6				12
25,2 cm Ø x 27,6 cm haut.	7,6 L	RFSCW8	RFS8PP	RFS8				12
37,8 cm Ø x 21,3 cm haut.	11,4 L	RFSCW12	RFS12PP	RFS12				6
37,8 cm Ø x 30,5 cm haut.	17,2 L	RFSCW18	RFS18PP	RFS18				6
37,8 cm Ø x 38,1 cm haut.	20,8 L	RFSCW22	RFS22PP	RFS22				6



Couvercle pour boîte ronde

Dimensions	Polycarbonate		Polypropylène		Polyéthylène		UE
	Code	Code	Code	Code			
Pour 0,9 L	RFSCWC1	RFSC1PP	RFSC1				12
Pour 1,9 / 3,8 L	RFSCWC2	RFSC2PP	RFSC2				12
Pour 5,7 / 7,6 L	RFSCWC6	RFSC6PP	RFSC6				12
Pour 11,4 / 17,2 / 20,8 L	RFSCWC12	RFSC12PP	RFSC12				6



Couvercle hermétique pour boîte en polycarbonate

Code	Description	UE
RFS1SCPP	Pour 0,9 L	12
RFS2SCPP	Pour 1,9/3,8 L	12
RFS6SCPP	Pour 5,7/7,6 L	12
RFS12SCPP	Pour 11,4/17,2/20,8 L	6



Pour commander des boîtes rondes sans mesures imprimées, ajoutez un "N" à la fin du code.

Tous les prix sont indiqués en P.V.P. unitaire.



Boîtes carrées

Les récipients carrés de CAMBRO sont l'option parfaite pour maximiser l'espace de stockage. Ils sont disponibles en 3 matériaux différents : polycarbonate transparent incassable, polyéthylène blanc et polypropylène translucide. Tous les récipients portent des mesures métriques et impériales.



uniquement polycarbonate

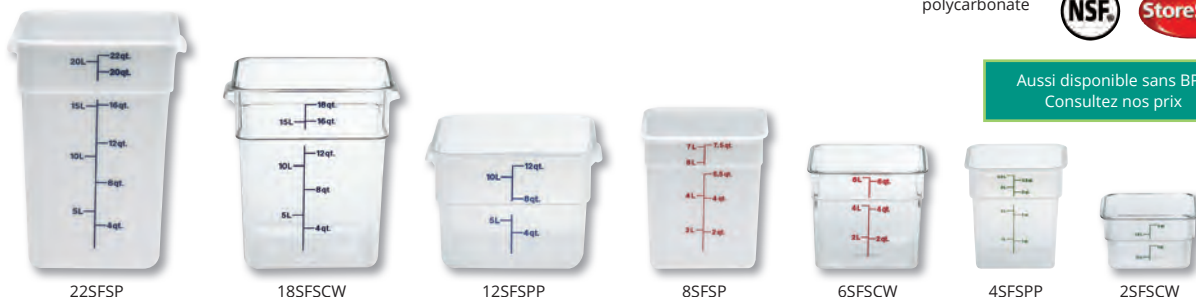

Aussi disponible sans BPA
Consultez nos prix

Boîte carrée

Dimensions	Capacité	Polycarbonate	Polypropylène	Polyéthylène	UE
		Code	Code	Code	
18,5 x 18,5 x 10 cm	1,9 L	2SFSCW	2SFSP	2SFSP	6
18,5 x 18,5 x 18,7 cm	3,8 L	4SFSCW	4SFSP	4SFSP	6
21,5 x 21,5 x 18,5 cm	5,7 L	6SFSCW	6SFSP	6SFSP	6
21,5 x 21,5 x 23 cm	7,6 L	8SFSCW	8SFSP	8SFSP	6
25,6 x 31 x 21 cm	11,4 L	12SFSCW	12SFSP	12SFSP	6
25,6 x 31 x 32 cm	17,2 L	18SFSCW	18SFSP	18SFSP	6
25,6 x 31 x 40 cm	20,8 L	22SFSCW	22SFSP	22SFSP	6

Couvercle pour boîte carrée

Code	Description	UE
SFC2	Pour tout matériel - 1,9/3,8 L	6
SFC6	Pour tout matériel - 5,7/7,6 L	6
SFC12	Pour tout matériel - 11,4/17,2/20,8 L	6
SFC2SCPP	Pour polycarbonate - 1,9/3,8 L	6
SFC6SCPP	Pour polycarbonate - 5,7/7,6 L	6
SFC12SCPP	Pour polycarbonate - 11,4/17,2/20,8 L	6



Tous les articles en **gras** sont des produits de stock habituel. Consulter les couleurs disponibles.



Boîte carrée Allergen-free

Code	Description	UE
2SFSCW 441	1,9 L	6
4SFSCW 441	3,8 L	6
6SFSCW 441	5,7 L	6
8SFSCW 441	7,6 L	6
12SFSCW 441	11,4 L	6
18SFSCW 441	17,2 L	6
22SFSCW 441	20,8 L	6

Couvercle Allergen-free

Code	Description	UE
SFC2SCPP 441	Pour 1,9 et 3,8 L	6
SFC6SCPP 441	Pour 5,7 et 7,6 L	6
SFC12SCPP 441	Pour 11,3; 17 et 20,8 L	6



Accédez aux principaux outils de Cambro

L'application Cambro vous donne instantanément accès aux principaux outils et aux ressources de Cambro.

De la personnalisation d'un plateau jusqu'à la découverte de la gamme complète de conteneurs de Cambro.

<https://www.cambro.com/app/>



Tous les prix sont indiqués en P.V.P. unitaire.

Boîtes de stockages

Les boîtes de stockage de CAMBRO sont calibrées sur la base de 46 x 66 cm (pour les grandes) et 30,5 x 46 cm (pour les petites) en différentes hauteurs. Elles disposent d'accessoires tels que les bacs d'écoulement ou les égouttoirs utiles pour la décongélation des poissons et des viandes et des couvercles coulissants qui évitent les contaminations. Elles sont disponibles en polycarbonate transparent incassable ou en polyéthylène blanc.



18263CW



182612P



1218SCCW



1826CP



18268CLRCW



1826DSCW

Boîte		uniquement polycarbonate		UE
Dimensions	Capacité	Code	Code	
46 x 66 x 9 cm	18,9 L	18263CW	18263P	6
46 x 66 x 15 cm	33,1 L	18266CW*	18266P	6
46 x 66 x 23 cm	49,2 L	18269CW	18269P	4
46 x 66 x 30 cm	64,4 L	182612CW	182612P	4
46 x 66 x 38 cm	83,3 L	182615CW	182615P	3
30,5 x 46 x 9 cm	6,6 L	12183CW	12183P	6
30,5 x 46 x 15 cm	11,4 L	12186CW**	12186P	6
30,5 x 46 x 23 cm	18 L	12189CW	12189P	6

* 18266CW couleurs disponibles : transparent (18266CW-135), rouge (18266CW-467), jaune (18266CW-464), bleu (18266CW-465).

** 12186CW couleurs disponibles : transparent (12186CW-135), rouge (12186CW-467) et jaune (18266CW-464).

Couvercle

Dimensions	Polycarbonate	Polyéthylène	UE
	Code	Code	
Plat - 45,7 x 66 cm	1826CCW*	1826CP	6
Coulissant - 45,7 x 66 cm	1826SCCW	-	6
Plat - 30,5 x 45,7 cm	1218CCW	1218CP	6
Coulissant - 30,5 x 45,7 cm	1218SCCW	-	6

* 1826CCW couleurs disponibles : transparent (1826CCW-135), rouge (1826CCW-467), jaune (1826CCW-464) et bleu (1826CCW-465).

Accessoires

Code	Description	UE
1826DSCW	Égouttoir pour boîte 46 x 66 cm	6
1218DSCW	Égouttoir pour boîte 30,5 x 46 cm	6
1826CLRCW*	Bac d'écoulement 45,7 x 66 x 12,7 cm	6
18268CLRCW	Bac d'écoulement 45,7 x 66 x 20 cm	4

*1826CLRCW couleurs disponibles : transparent (1826CLRCW-135), rouge (1826CLRCW-467), jaune (1826CLRCW-464) et bleu (1826CLRCW-465).

Boîtes Camwear pour le stockage des aliments sont disponibles en plusieurs couleurs

Ref. color 467

Ref. color 464

Ref. color 465



- Évite la contamination croisée.
- Le couleur identifie clairement le produit à l'intérieur.
- Couvercles plats de la même couleur. Modèles disponibles en rouge, jaune et bleu : 18266CW, 1826CCW y 1826CLRCW.
- Modèles disponibles en rouge et jaune : 12186CW, 1218CCW.

Boîte

Dimensions	Capacité	Polycarbonate	
		Code	UE
30,5 x 46 x 15 cm	11,4 L	12186CW	6
46 x 66 x 15 cm	33,1 L	18266CW	6

Couvercle

Dimensions	Code	UE
Plat - 30,5 x 45,7 cm	1218CCW	6
Plat - 45,7 x 66 cm	1826CCW	6

Boîte perforée - bac d'écoulement

Dimensions	Code	UE
45,7 x 66 x 12,7 cm	1826CLRCW	6

Tous les articles en **gras** sont des produits de stock habituel. Consulter les couleurs disponibles.

Boîtes de stockage GN en polypropylène

Le polypropylène est un plastique translucide, économique, très populaire dans le secteur de l'hôtellerie. Les récipients GN en polypropylène de CAMBRO sont un choix idéal pour des budgets plus serrés, bénéficiant à tout moment de l'assurance qualité de CAMBRO. Les couvercles en option peuvent être simples ou semi-hermétiques et il existe également des égouttoirs en polypropylène. Elles résistent à des températures de -40 °C à 70 °C.



GN 1/1 - 32,5 x 53 cm



Bac GN 1/1 - 32,5 x 53 cm

Code	Description	Couleurs	UE
12PP	6,5 cm prof. - 8,5 L	190 <input type="checkbox"/>	6
14PP	10 cm prof. - 13 L	190 <input type="checkbox"/>	6
16PP	15 cm prof. - 19,5 L	190 <input type="checkbox"/>	6
18PP	20 cm prof. - 25,6 L	190 <input type="checkbox"/>	6
10PPD	Égouttoir	190 <input type="checkbox"/>	6

Couvercle GN 1/1 - 32,5 x 53 cm

Code	Description	Couleurs	UE
10PPCH	À poignée	190 <input type="checkbox"/>	6
10PPCWSC	Hermétique	190 <input type="checkbox"/>	6

GN 1/2 - 26,5 x 32,5 cm



Bac GN 1/2 - 26,5 x 32,5 cm

Code	Description	Couleurs	UE
22PP	6,5 cm prof. - 3,9 L	190 <input type="checkbox"/>	6
24PP	10 cm prof. - 5,9 L	190 <input type="checkbox"/>	6
26PP	15 cm prof. - 8,9 L	190 <input type="checkbox"/>	6
28PP	20 cm prof. - 11,7 L	190 <input type="checkbox"/>	6
20PPD	Égouttoir	190 <input type="checkbox"/>	6

Couvercle GN 1/2 - 26,5 x 32,5 cm

Code	Description	Couleurs	UE
20PPCH	À poignée	190 <input type="checkbox"/>	6
20PPCWSC	Hermétique	190 <input type="checkbox"/>	6

GN 1/3 - 17,6 x 32,5 cm



Bac GN 1/3 - 17,6 x 32,5 cm

Code	Description	Couleurs	UE
32PP	6,5 cm prof. - 2,4 L	190 <input type="checkbox"/>	6
34PP	10 cm prof. - 3,6 L	190 <input type="checkbox"/>	6
36PP	15 cm prof. - 5,3 L	190 <input type="checkbox"/>	6
30PPD	Égouttoir	190 <input type="checkbox"/>	6

Couvercle GN 1/3 - 17,6 x 32,5 cm

Code	Description	Couleurs	UE
30PPCH	À poignée	190 <input type="checkbox"/>	6
30PPCHN	À encoche et poignée	190 <input type="checkbox"/>	6
30PPCWSC	Hermétique	190 <input type="checkbox"/>	6

Tous les prix sont indiqués en P.V.P. unitaire.

Boîtes de stockage GN en polypropylène (suite)

GN 1/4 - 16,2 x 26,5 cm



46PP



44PP



Bac GN 1/4 - 16,2 x 26,5 cm

Code	Description	Couleurs	UE
42PP	6,5 cm prof. - 1,7 L	190 <input type="checkbox"/>	6
44PP	10 cm prof. - 2,5 L	190 <input type="checkbox"/>	6
46PP	15 cm prof. - 3,7 L	190 <input type="checkbox"/>	6
40PPD	Égouttoir	190 <input type="checkbox"/>	6

Couvercle GN 1/4 - 16,2 x 26,5 cm

Code	Description	Couleurs	UE
40PPCH	À poignée	190 <input type="checkbox"/>	6
40PPCWSC	Hermétique	190 <input type="checkbox"/>	6

GN 1/6 - 16,2 x 17,6 cm



66PP



64PP



Bac GN 1/6 - 16,2 x 17,6 cm

Code	Description	Couleurs	UE
62PP	6,5 cm prof. - 1 L	190 <input type="checkbox"/>	6
64PP	10 cm prof. - 1,5 L	190 <input type="checkbox"/>	6
66PP	15 cm prof. - 2,2 L	190 <input type="checkbox"/>	6
60PPD	Égouttoir	190 <input type="checkbox"/>	6

Couvercle GN 1/6 - 16,2 x 17,6 cm

Code	Description	Couleurs	UE
60PPCH	À poignée	190 <input type="checkbox"/>	6
60PPCHN	À encoche et poignée	190 <input type="checkbox"/>	6
60PPCWSC	Hermétique	190 <input type="checkbox"/>	6

GN 1/9 - 10,8 x 17,6 cm



94PP



Bac GN 1/9 - 10,8 x 17,6 cm

Code	Description	Couleurs	UE
92PP	6,5 cm prof. - 0,57 L	190 <input type="checkbox"/>	6
94PP	10 cm prof. - 0,85 L	190 <input type="checkbox"/>	6
90PPD	Égouttoir	190 <input type="checkbox"/>	6

Couvercle GN 1/9 - 10,8 x 17,6 cm

Code	Description	Couleurs	UE
90PPC	Plat	190 <input type="checkbox"/>	6
90PPCWSC	Hermétique	190 <input type="checkbox"/>	6

Tous les articles en **gras** sont des produits de stock habituel. Consulter les couleurs disponibles.

Bacs Gastronomes en CamView

Les bacs gastronomes CamView sont fabriqués avec un matériau sans BPA, à la fois transparent et résistant aux tâches, capable de supporter des températures de -40° à 71 °C, et de subir en toute sécurité un nettoyage haute température dans les lave-vaisselles industriels.

Aussi disponible sans BPA
Consultez nos prix



GN 1/1 - 32,5 x 53 cm

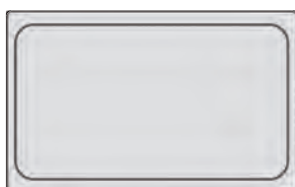

Code	Description	Couleurs	UE
Bac GN 1/1 - 32,5 x 53 cm			
12CV1	6,5 cm prof. - 8,5 L	335 □	6
14CV1	10 cm prof. - 13 L	335 □	6
16CV1	15 cm prof. - 19,5 L	335 □	6
18CV1	20 cm prof. - 25,6 L	335 □	6
10CV1D	Égouttoir	335 □	6

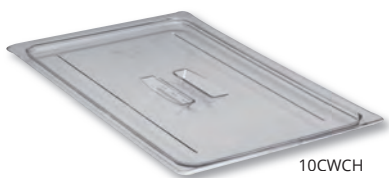

10CWCH

Couvercle GN 1/1 - 32,5 x 53 cm

10CV1CH	À poignée	335 □	6
----------------	-----------	-------	---

Le rebord uniforme de 1,27 cm assure un placement facile des bacs sur les tables de préparation et les buffets.

Les bacs gastronomes CamView sont sans BPA, transparents et résistent aux tâches. Ces bacs sont capables de supporter des températures de -40 à 71 °C.

Graduations permettant une gestion facile des stocks.

Aucune réaction chimique aux produits alimentaires, ce qui évite les dangers potentiels de réactions aux produits chimiques ou acides.

La surface intérieure anti-adhérente se traduit par de meilleurs rendements et facilite le nettoyage.

Surface granitée résistant aux éraflures.

Tous les prix sont indiqués en P.V.P. unitaire.



GN 1/2 - 26,5 x 32,5 cm



Code	Description	Couleurs	UE
Bac GN 1/2 - 26,5 x 32,5 cm			
22CV1	6,5 cm prof. - 3,9 L	335 □	6
24CV1	10 cm prof. - 5,9 L	335 □	6
26CV1	15 cm prof. - 8,9 L	335 □	6
28CV1	20 cm prof. - 11,7 L	335 □	6
20CV1D	Égouttoir	335 □	6
Couvercle GN 1/2 - 26,5 x 32,5 cm			
20CV1CH	À poignée	335 □	6

GN 1/3 - 17,6 x 32,5 cm

Code	Description	Couleurs	UE
Bac GN 1/3 - 17,6 x 32,5 cm			
32CV1	6,5 cm prof. - 2,4 L	335 □	6
34CV1	10 cm prof. - 3,6 L	335 □	6
36CV1	15 cm prof. - 5,3 L	335 □	6
38CV1	20 cm prof. - 6,9 L	335 □	6
30CV1D	Égouttoir	335 □	6
Couvercle GN 1/3 - 17,6 x 32,5 cm			
30CV1CH	À poignée	335 □	6

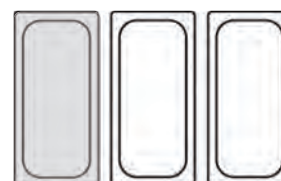

GN 1/4 - 16,2 x 26,5 cm



Code	Description	Couleurs	UE
Bac GN 1/4 - 16,2 x 26,5 cm			
42CV1	6,5 cm prof. - 1,7 L	335 □	6
44CV1	10 cm prof. - 2,5 L	335 □	6
46CV1	15 cm prof. - 3,7 L	335 □	6
40CV1D	Égouttoir	335 □	6
Couvercle GN 1/4 - 16,2 x 26,5 cm			
40CV1CH	À poignée	335 □	6

Tous les articles en **gras** sont des produits de stock habituel. Consulter les couleurs disponibles.

GN 1/6 - 16,2 x 17,6 cm



Code	Description	Couleurs	UE
Bac GN 1/6 - 16,2 x 17,6 cm			
62CV1	6,5 cm prof. - 1 L	335 □	6
64CV1	10 cm prof. - 1,5 L	335 □	6
66CV1	15 cm prof. - 2,2 L	335 □	6
60CV1D	Égouttoir	335 □	6

Couvercle GN 1/6 - 16,2 x 17,6 cm

60CV1CH	À poignée	335 □	6
----------------	-----------	-------	---

GN 1/9 - 10,8 x 17,6 cm

Code	Description	Couleurs	UE
Bac GN 1/9 - 10,8 x 17,6 cm			
92CV1	6,5 cm prof. - 0,57 L	335 □	6
94CV1	10 cm prof. - 0,85 L	335 □	6
90CV1D	Égouttoir	335 □	6

Couvercle GN 1/9 - 10,8 x 17,6 cm

90CV1C	Plat	335 □	6
---------------	------	-------	---



Accédez aux principaux outils de Cambro

L'application Cambro vous donne instantanément accès aux principaux outils et aux ressources de Cambro.

De la personnalisation d'un plateau jusqu'à la découverte de la gamme complète de conteneurs de Cambro.

<https://www.cambro.com/app/>



Tous les prix sont indiqués en P.V.P. unitaire.

Sacs de ration

Améliorez la gestion de votre inventaire avec ces sacs de stockage. Ils sont durables, faciles à utiliser et conçu pour une inscription aisée. Ils permettent de contrôler les rations de nourriture de tout type d'aliment préparé, comme la viande, les fruits, les légumes ou les desserts. Étiquetage trilingue (espagnol, anglais et français).

Code	Description	UE
SB6701	Lundi. Transparent, étiquette bleue. 165 mm x 175 mm. 2.000 unités par paquet.	1
SB6702	Mardi. Transparent, étiquette jaune. 165 mm x 175 mm. 2.000 unités par paquet.	1
SB6703	Mercredi. Transparent, étiquette rouge. 165 mm x 175 mm. 2.000 unités par paquet.	1
SB6704	Jeudi. Transparent, étiquette marron. 165 mm x 175 mm. 2.000 unités par paquet.	1
SB6705	Vendredi. Transparent, étiquette verte. 165 mm x 175 mm. 2.000 unités par paquet.	1
SB6706	Samedi. Transparent, étiquette orange. 165 mm x 175 mm. 2.000 unités par paquet.	1
SB6707	Dimanche. Transparent, étiquette noire. 165 mm x 175 mm. 2.000 unités par paquet.	1
DISPSB-65	Distributeur de sacs de 165 mm x 175 mm.	1



SB6701



SB6702



SB6703



SB6704



SB6705



SB6706



SB6707

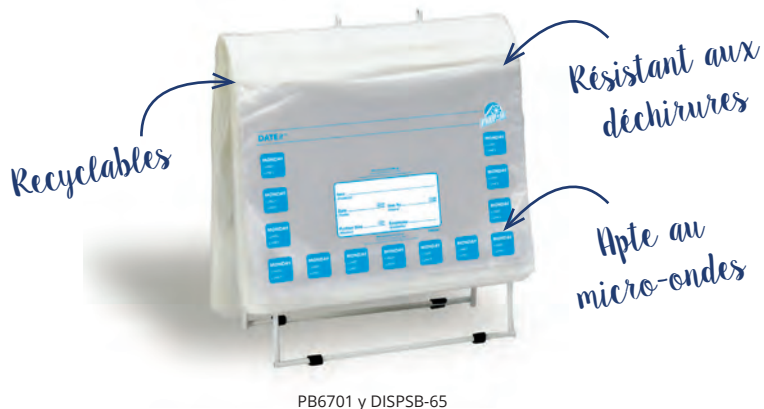

PB6701 y DISPSB-65

Tous les articles en **gras** sont des produits de stock habituel. Consulter les couleurs disponibles.



Nouveauté

■ Échelles Gastronorme GN 1/1

Fabriqués dans le même matériau composite que notre gamme de rayonnages, avec des surfaces faciles à nettoyer, nos chariots garantissent aux utilisateurs des années de haute performance et de sécurité des processus.
Disponible en deux capacités : GN1/1 et GN 2/1.



UGNPR11H9

Échelle basse GN 1/1
73,03 x 43,8 x 101,6 cm



● 480



UGNPR11F18

Échelle haute GN 1/1
73,03 x 43,8 x 170,7 cm



● 480



GBCTUGNPR11-CLR

Housse en vinyle pour échelles hautes. Pour GN 1/1
66,3 x 47,2 x 154,4 cm



Clear (CLR)

Capacité de l'échelle pour récipients GN 1/1 (1 récipient taille standard par jeu de glissière, à chargement frontal)

	Échelle haute				Échelle basse			
	6,5 cm	10 cm	15 cm	20 cm	6,5 cm	10 cm	15 cm	20 cm
1/1 récipients	18	9	9	6	9	4	4	3
1/2 récipients	36	18	18	12	18	8	8	6
1/3 récipients	54	27	27	18	27	12	12	9

Tous les prix sont indiqués en P.V.P. unitaire.

Échelles Gastronorme GN 2/1



UGNPR21H18

Échelle basse GN 2/1

83,5 x 64,5 x 101,6 cm

1

480



UGNPR21F36

Échelle haute GN 2/1

83,5 x 64,5 x 170,7 cm

1

480



GBCTUGNPR21-CLR

Housse en vinyle pour échelles hautes. Pour GN 2/1

66,3 x 47,2 x 154,4 cm

1

Clear (CLR)

Capacité de l'échelle pour récipients GN 2/1 (2 récipient taille standard par jeu de glissière, à chargement latéral)

	Échelle haute				Échelle basse			
	6,5 cm	10 cm	15 cm	20 cm	6,5 cm	10 cm	15 cm	20 cm
1/1 récipients	36	18	18	12	18	8	8	6



BUTÉES D'ARRÊT MOULÉES

De 3 mm. Moulées à l'extrémité de chaque rail pour assurer la stabilité pendant le transport.

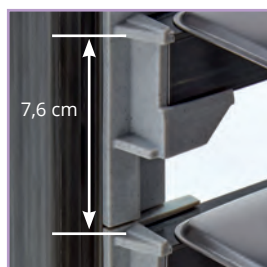

L'ESPACE ENTRE LES RAILS

L'espace de 7,6 cm entre chaque rail offre une grande modularité et une facilité d'utilisation.



MANIABILITÉ - STABILITÉ

Les cadres de verrouillage, haut et bas, associés aux roulettes en plastique de qualité supérieure assurent un déplacement facile et silencieux des échelles en tout lieu.

SÉCURITÉ ALIMENTAIRE AMÉLIORÉE

Le cadre supérieur unique supporte 1 ou 2 Bacs GN 1/1 ou utilisez une planche à découper GN 1/1 (échelle GN 1/1 demi-taille uniquement).

ENTIÈREMENT ACCESSIBLE

La conception des échelles, sans barres latérales ou transversales, permet un accès facile et sans entrave au contenu.

ROUES PREMIUM

Les roues de 12,7 cm en caoutchouc thermoplastique non marquant sont toutes pivotantes avec frein de blocage total.

FACILE À NETTOYER

Résistant aux acides alimentaires ou aux produits chimiques agressifs. Pas d'angles vifs difficiles d'accès pour le nettoyage



Tous les articles en **gras** sont des produits de stock habituel. Consulter les couleurs disponibles.

Étiquettes solubles de rotation des aliments

- Les étiquettes et l'adhésif se dissolvent en moins de 30 secondes.
- Passez-les au lave-vaisselle ou sous l'eau courante chaude ou froide.
- Peuvent supporter des températures de congélation atteignant -40 °C.
- Peuvent supporter des températures élevées jusqu'à 93 °C durant 4 horas.
- 100 % solubles et biodégradables.



DISOLUBLES



23SLINB250

Étiquette soluble

Code	Description	UE
1252SLINB250	24 rouleaux de 250 étiqu. - 3 x 5 cm	1
23SLINB250	24 rouleaux de 250 étiqu. - 5 x 7,6 cm	1
SLL30	100 feuilles de 30 étiqu. - format USA	1



1252SLINB250



SLL30



Totalement solubles quand le récipient est passé au lave-vaisselle ou à l'eau courante.



Éliminent les résidus collants et empêchent la contamination croisée. ¡Fini le grattage!

Étiquettes amovibles de rotation des aliments

- Se collent et se décollent très facilement avant le lavage.
- Supporte des températures de -40 °C jusqu'à 71 °C.
- Permettent un système personnalisé et une parfaite gestion de l'inventaire.



DESPEGABLES

Étiquette amovible JOURS

Code	Description	UE
FR-R101	Rouleau de 1000 étiquettes LUNDI - 2,5 x 2,5 cm	6
FR-R102	Rouleau de 1000 étiquettes MARDI - 2,5 x 2,5 cm	6
FR-R103	Rouleau de 1000 étiquettes MERCREDI - 2,5 x 2,5 cm	6
FR-R104	Rouleau de 1000 étiquettes JEUDI - 2,5 x 2,5 cm	6
FR-R105	Rouleau de 1000 étiquettes VENDREDI - 2,5 x 2,5 cm	6
FR-R106	Rouleau de 1000 étiquettes SAMEDI - 2,5 x 2,5 cm	6
FR-R107	Rouleau de 1000 étiquettes DIMANCHE - 2,5 x 2,5 cm	6



Tous les prix sont indiqués en P.V.P. unitaire.

Étiquettes amovibles de rotation des aliments (suite)

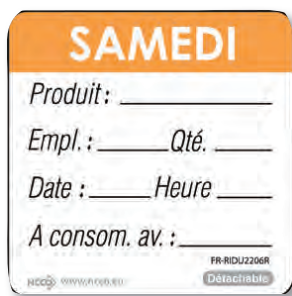

Étiquette amovible DÍAS

Code	Description	UE
FR-RIDU2201	Rouleau de 500 étiqu. LUNDI - 5 x 5 cm	6
FR-RIDU2202	Rouleau de 500 étiqu. MARDI - 5 x 5 cm	6
FR-RIDU2203	Rouleau de 500 étiqu. MERCREDI - 5 x 5 cm	6
FR-RIDU2204	Rouleau de 500 étiqu. JEUDI - 5 x 5 cm	6
FR-RIDU2205	Rouleau de 500 étiqu. VENDREDI - 5 x 5 cm	6
FR-RIDU2206	Rouleau de 500 étiqu. SAMEDI - 5 x 5 cm	6
FR-RIDU2207	Rouleau de 500 étiqu. DIMANCHE - 5 x 5 cm	6



Etiqueta despegable especial

Code	Description	UE
FR-RUF2	Rouleau de 500 étiqu. trilingue USE FIRST - 5 cm Ø	6

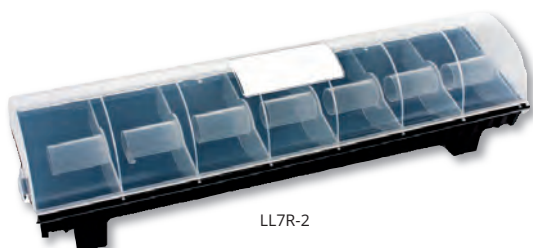

LL7R-2



LL1R-2-12M



SR100-KIT-M

Étiquettes non incluses

Distributeur + étiquettes

Code	Description	UE
LL7R-2	Pour 7 rouleaux d'étiquettes de 5 cm	1
LL1R-2-12M	Pour 1 rouleau d'étiquettes de 2,5 ou 5 cm	1
FR-R100-KIT	Kit 7 rouleaux d'étiquettes + distributeur	1

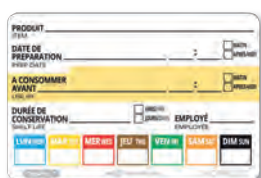

FR-DPIPUS23

Étiquette amovible - Semainier

Code	Description	UE
FR-DPIPUS23	Étiquettes amovibles pour 7 jours de la semaine - 5 x 8 cm 500 étiquettes par rouleau	1



Étiquettes amovible ALLERGÈNES

Code	Description	UE
DBRALG22R	Rouleau de 500 étiquettes - 5 x 5 cm	6

- Conformément à la nouvelle réglementation UE-1169/2011, le label d'allergènes signale la présence d'allergènes dans les aliments.
- 14 groupes d'allergènes sont clairement définis.

Tous les articles en **gras** sont des produits de stock habituel. Consulter les couleurs disponibles.



■ Étiquettes Secure-It

Ces étiquettes permanentes et à l'épreuve des manipulations Secure-It sont pourvues d'un adhésif fort avec des marques prédécoupées qui se déchirent dès qu'elles sont altérées.

Code	Description	Dimensions	UE
P13SI-2	Étiquettes de sécurité à l'épreuve des manipulations. Lot de 2 rouleaux de 250 étiquettes.	2,5 x 7,5 cm	1
P18.5-SI-2	Étiquettes de sécurité à l'épreuve des manipulations (ruban de sécurité) Lot de 2 rouleaux de 250 étiquettes.	2,5 x 20,3 cm	1
P16SI-2	Étiquettes de sécurité à l'épreuve des manipulations. Lot de 2 rouleaux de 250 étiquettes.	3,8 x 15,2 cm	1
P26SI-2	Étiquettes de sécurité à l'épreuve des manipulations. Lot de 2 rouleaux de 250 étiquettes.	6,4 x 15,2 cm	1



Rejoignez-nous



@DbmarkTweet



@dbmarkhosteleria



@dbmark_inst

Tous les prix sont indiqués en P.V.P. unitaire.



Les petites présentations du Chef : nous vous présentons une collection de petites poêles et casseroles qui rompent avec la manière traditionnelle de présenter les plats, vous offrant une nouvelle façon de servir vos créations culinaires. Pour cuisiner et servir d'une manière très attrayante des rations individuelles.

Les outils du Chef : chaque cuisinier développe son propre talent, chaque région sa tradition et chaque fourneau sa spécialité, mais quand il s'agit de travailler dans la cuisine, il est indispensable de disposer d'équipements et des outils de travail qui permettent de gagner du temps et de l'argent et qui facilitent le travail de ces professionnels essentiels de la restauration. Dans les pages suivantes, vous trouverez une sélection des accessoires de cuisine de TABLECRAFT.

Le four du chef : Le four est l'un des dispositifs les plus importants pour le chef ou le cuisinier. L'art de l'utiliser consiste à sélectionner soigneusement les pièces à utiliser, en termes de forme, de taille, de type de matériau et de type d'aliment à cuisiner. Vous trouverez une sélection de pièces et d'accessoires de qualité supérieure comme les bacs GN à haute température de CAMBRO, les récipients en acier inoxydable et aluminium d'AGNELLI ou les gants ignifuges et résistants à la vapeur de TUCKER. Profiter de la cuisine sera plus facile et plus sûr que jamais.

■ Fonte

Pièces en fonte pour cuisiner et servir. Surface antidérapante et facile à nettoyer.

- Pour frire, cuire, mettre au four et servir dans un même récipient.
- Extrême durabilité, excellente option pour un usage prolongé.



CW30152

Faitout rond

19 Ø x 3,5 cm,
26 Ø con asas - 710 ml



CW30114

Faitout carré

27 x 27 x 5,5 cm - 2,6 L



CW30116

Wok

36.5 Ø x 11,5 cm,
44,5 Ø cm con asas - 6,8 L



CW30118

Plat à four à pizza

34.5 Ø x 2 cm,
44,5 Ø cm avec poignées



FSR3

Set de Fajita. Base, plat et gant inclus

40,6 x 22,9 x 4,1 cm



Rejoignez-nous



@DbmarkTweet



@dbmarkhosteleria



@dbmark_inst

Tous les prix sont indiqués en P.V.P. unitaire.



■ Fonte (suite)

Cuisine et présentation dans une seule et même pièce.



CW30130

Poêle

21,5 Ø x 6 cm,
Manche 16 cm



CW30132

Poêle

26,5 Ø x 6 cm,
Manche 16 cm



CW30134

Poêle

31 cm Ø x 6 cm,
Manche 16 cm



Tous les articles en **gras** sont des produits de stock habituel. Consulter les couleurs disponibles.



■ Bouteilles à sauce souples



10853C-12

Bouteille souple
avec ouverture de
53 mm

5,1 x 5,1 x 17,1 cm
240 ml

12

○ N

11253C-12

Bouteille souple
avec ouverture de
53 mm

6 x 6 x 21,9 cm
355 ml

12

○ N

11663C-12

Bouteille souple
avec ouverture de
63 mm

7 x 7 x 20,3 cm
475 ml

12

○ N



10853M-12

Bouteille souple
avec ouverture de
53 mm / Moutarde

5,1 x 5,1 x 17,1 cm
240 ml

12

● Y

11253M-12

Bouteille souple
avec ouverture de
53 mm / Moutarde

6 x 6 x 21,9 cm
355 ml

12

● Y

11663M-12

Bouteille souple
avec ouverture de
63 mm / Moutarde

7 x 7 x 20,3 cm
475 ml

12

● Y



10853K-12

Bouteille souple
avec ouverture de
53 mm / Ketchup

5,1 x 5,1 x 17,1 cm -
240 ml

12

● R

11253K-12

Bouteille souple
avec ouverture de
53 mm / Ketchup

6 x 6 x 21,9 cm -
355 ml

12

● R

11663K-12

Bouteille souple
avec ouverture de
63 mm / Ketchup

7 x 7 x 20,3 cm -
475 ml

12

● R

Tous les prix sont indiqués en P.V.P. unitaire.

■ Bouteilles à sauce souples (suite)



12463C-12

Bouteille souple avec ouverture de 63 mm

7 x 7 x 26 cm
710 ml

12

N



3263C

Bouteille souple avec ouverture de 63 mm

8,3 x 8,3 x 26,4 cm
950 ml

12

N



31763C

Bouteille souple avec ouverture de 63 mm et embout large

7 x 7 x 20,3 cm
475 ml

24

N



32563C

Bouteille souple avec ouverture de 63 mm et embout large

7 x 7 x 26 cm - 710 ml

12

N

3263K

Bouteille souple avec ouverture de 63 mm et bouchon rouge

8,3 x 8,3 x 26,4 cm - 950 ml

12

N R



3263M

Bouteille souple avec ouverture de 63 mm et bouchon jaune

8,3 x 8,3 x 26,4 cm - 950 ml

12

N Y



11663C3

Bouteille souple Selectop avec ouverture de 63 mm / 3 tip top

7 x 7 x 20 cm - 475 ml

12

N

11663C3F

Bouteille souple Dualway avec ouverture de 63 mm / 3 tip top

6,4 x 6,4 x 22,5 cm - 475 ml

12

N

11663CF

Bouteille souple Dualway avec ouverture de 63 mm / embout conique

7 x 7 x 22,5 cm - 475 ml

12

N

12463C3

Bouteille souple Selectop avec ouverture de 63 mm / 3 tip top

7 x 7 x 26,4 cm - 710 ml

12

N

12463C3F

Bouteille souple Dualway avec ouverture de 63 mm / 3 tip top

7 x 7 x 26,4 cm - 710 ml

12

N

12463CF

Bouteille souple Dualway avec ouverture de 63 mm embout conique

7 x 7 x 25,4 cm - 710 ml

12

N

63TC3

Bouteille souple avec ouverture de 63 mm / 3 tip top

7 x 7 x 6 cm

12

N

3263C3

Bouteille souple Selectop avec ouverture de 63 mm / 3 tip top

8,3 x 8,3 x 25,4 cm - 950 ml

12

N

Tous les articles en **gras** sont des produits de stock habituel. Consulter les couleurs disponibles.



SB53A

Anneaux en silicone pour bouteilles de 53 mm

5,4 x 5,4 x 1,7 cm

☞ 1

Mix - 12 par paquet.

● BK ● R ● Y
● LGN ● LBL ● BL



SB63A

Anneaux en silicone pour bouteilles de 63 mm

7 x 7 x 1,9 cm

☞ 1

Mix - Chaque paquet inclut 2 anneaux de chaque couleur :

● BK ● R ● Y
● LGN ● LBL ● BL



C100TA

Bouchon pour bouteille souple

8,4 x 1,4 x 1,1 cm

☞ 1

Mix - Chaque paquet inclut 2 anneaux de chaque couleur :

● BK ● R ● Y
● LGN ● LBL ● BL



C100TPR

Bouchon pour bouteille souple

8,4 x 1,4 x 1,1 cm

☞ 1

12 par paquet.

● PR



C100TC

Bouchon pour bouteille souple

8,4 x 1,4 x 1,1 cm

☞ 1

6 par paquet.

○ N



SB53PR

Anneaux en silicone pour bouteilles de 53 mm

5,4 x 5,4 x 1,7 cm

☞ 1

12 par paquet.

● PR



SB63PR

Anneaux en silicone pour bouteilles de 63 mm

7 x 7 x 1,9 cm

☞ 1

12 par paquet.

● PR



1102

Bouteille souple pour décoration

3 x 3 x 12 cm
60 ml

☞ 24

○ N



H110204

Jeu de 2 bouteilles pour décoration

3,8 x 3,8 x 14,6 cm
60 / 118 ml

☞ 6

○ N

Tous les prix sont indiqués en P.V.P. unitaire.



■ Bouteilles souples – Concept FIFO



N20C

Bouteille souple SaferFood avec ouverture de 63 mm

7 x 7 x 22,5 cm - 519 ml



N20CBBQ

Bouteille souple SaferFood avec ouverture de 63 mm et brosse en silicone

8,3 x 8,3 x 25,4 cm - 519 ml



N63BBQ

Brosse incolore en silicone pour bouteille souple de 591 ou 710 ml.

7,6 x 7,6 x 8,3 cm



12SV

Bouteille incolore avec bouchon ValveTop avec ouverture 53 mm

6 x 6 x 18,5 cm
355 ml



16SV

Bouteille incolore avec bouchon ValveTop avec ouverture 53 mm

5,9 x 5,9 x 21,9 cm
475 ml



24SV

Bouteille incolore incolore avec bouchon ValveTop avec ouverture 63 mm

7 x 7 x 22,9 cm
710 ml



53FCAPBL

Bouchon 53 mm. InvertaTop

53 cm de Ø



53FCAPPR

Bouchon 53 mm. InvertaTop

53 cm de Ø



Tous les articles en **gras** sont des produits de stock habituel. Consulter les couleurs disponibles.

Bouteilles souples – Concept FIFO (suite)



53FCAPBK

Bouchon 53 mm. InvertaTop
53 cm de Ø

12

● BK



53FCAPY

Bouchon 53 mm. InvertaTop
53 cm de Ø

12

● Y



53FCAPLBL

Bouchon 53 mm. InvertaTop
53 cm de Ø

12

● LBL



53FCAPLGN

Bouchon 53 mm. InvertaTop
53 cm de Ø

12

● LGN



T3456

Support pour bouteilles
souples, 3 trous
27 x 9,5 x 5,4 cm

1

● INOX.



T4

Support pour bouteilles
souples, 4 trous
17,8 x 15,9 x 1 cm

1

● INOX.



T6

Support pour bouteilles
souples, 6 trous
32,4 x 17,8 x 1 cm

1

● INOX.



T8

Support pour bouteilles
souples, 8 trous
32,4 x 17,8 x 1 cm

1

● INOX.



Solutions SaferFood

- Ce système élimine l'usage des pinceaux à sauces ou à pâtisserie.
- Évite la perte de mèche dans les aliments.
- Permet de répandre et de badigeonner simultanément.
- Apte au lavage au lave-vaisselle.
- Fabriqué en silicone haute température.



Système InvertaTop - Concept FIFO

- Répond facilement les produits.
- Se remplit et garde sa position inversée pour un usage plus simple et rapide.
- Deux ouvertures faciles à laver et à remplir.
- Excellent pour les condiments à haute viscosité.

Tous les prix sont indiqués en P.V.P. unitaire.

■ Distributeurs à pompes en plastique



663

Distributeur à pompe 30 ml
et tube de 23 cm

20,9 x 5 x 38,7 cm - 30 ml



663K

Set distributeur à pompe 663 + couvercle
(38 mm, 89 mm, 110 mm ou 160 mm)

15,9 x 15,9 x 38,1 cm



664

Maxi distributeur à pompe 30 ml,
tube de 23 cm et ouverture large

19 x 3,1 x 29,2 cm - 30 ml



664K

Set maxi distributeur à pompe 664
+ couvercle (38 mm, 89 mm, 110 mm
ou 160 mm)

19,1 x 2,9 x 29,2 cm



662

Distributeur à pompe économique 30 ml
et tube de 23 cm

12 x 5 x 35,5 cm - 30 ml



662K

Set distributeur à pompe économique
662 + couvercle (38 mm, 89 mm, 110 mm
ou 160 mm)

21 x 4,8 x 38,7 cm



■ Nouveauté ■

■ Bouteille en polyéthylène

Pour fournir avec précision une grande variété de condiments.



32C*

Bouteille en polyéthylène de
faible densité

950 ml



*Pompe non incluse



1032J*

Bouteille en polyéthylène
de haute densité

950 ml



1064J*

Bouteille en polyéthylène
de haute densité

1,9 L



1128J*

Bouteille en polyéthylène
de haute densité

3,7 L



Tous les articles en **gras** sont des produits de stock habituel. Consulter les couleurs disponibles.



Poches pâtisseries FROSTit

Poches pâtisseries professionnelles pour des créations extraordinaires. Deux couleurs disponibles : bleu et transparent. Facile à agripper même avec des gants et dotées de coutures fortes qui réduisent le risque de déchirure.

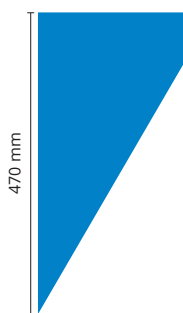

FI-18T0B-6

Poche pâtissière standard
100 unités/rouleau
47 cm de long

6

● BLEU



FI-21T0B-6

Poche pâtissière standard
100 unités/rouleau
53 cm de long

6

● BLEU

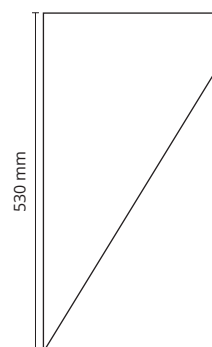

FI-21T0C-6

Poche pâtissière standard
100 unités/rouleau
53 cm de long

6

○ CLEAR

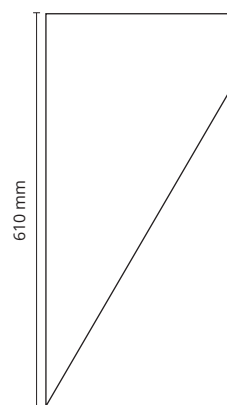

FI-24T0C-6

Poche pâtissière standard
100 unités/rouleau
61 cm de long

6

○ CLEAR

FI-18T3BX-6

Poche pâtissière antidérapante
100 unités/rouleau 43 cm
de long
43 cm de long

6

● BLEU



FI-21T3BX-6

Poche pâtissière antidérapante
100 unités/rouleau 53 cm
de long
53 cm de long

6

● BLEU



Tous les prix sont indiqués en P.V.P. unitaire.



■ Kits de douilles de décoration FROSTit

Laissez libre cours à votre imagination et concentrez-vous sur la décoration avec ces différents kits de douilles : plates, en étoile et décoratives. Chaque kit inclut :

- 8 douilles
- 2 bouchons
- 2 systèmes de coupleurs faciles à nettoyer
- 1 brosse de nettoyage douce
- 1 couvercle pour un stockage hygiénique
- 1 agenceur de douilles

FI-FTPLAIN

Kit de 8 douilles lisses



Ouvertures lisse



FI-FTSTAR

Kit de 8 douilles en forme d'étoile standard



Étoiles standard

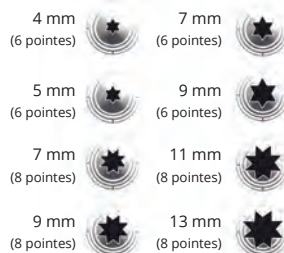

FI-FTFRENCH

Kit de 8 douilles en forme d'étoile française



Étoiles française

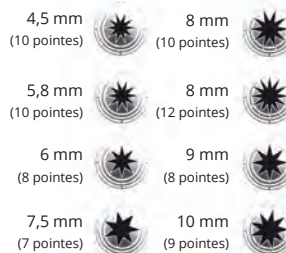

FI-FTDECO

Kit de 8 douilles décoratives + filtre et anneaux de vissage



Décoratives



filtre à beignets

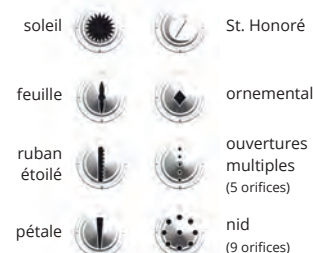

Tous les articles en **gras** sont des produits de stock habituel. Consulter les couleurs disponibles.

■ Distributeurs à poignée à pression



FB-PP16-3KIT

Distributeur 500 ml,
3 bouteilles, 3 bouchons
à orifice unique, 5 anneaux
de rations fixes et une poignée



Couleurs variées



FB-PP24-3KIT

Distributeur de 710 ml,
3 bouteilles, 3 bouchons
à orifice unique, 5 anneaux
de rations fixes et une poignée



Couleurs variées



FB-PPAL-RINGS

Assortiment de 5 anneaux
pour 7,5/10/15/30 et 22,5 ml

8,15 cm de Ø x 1,4 cm haut.



Couleurs variées

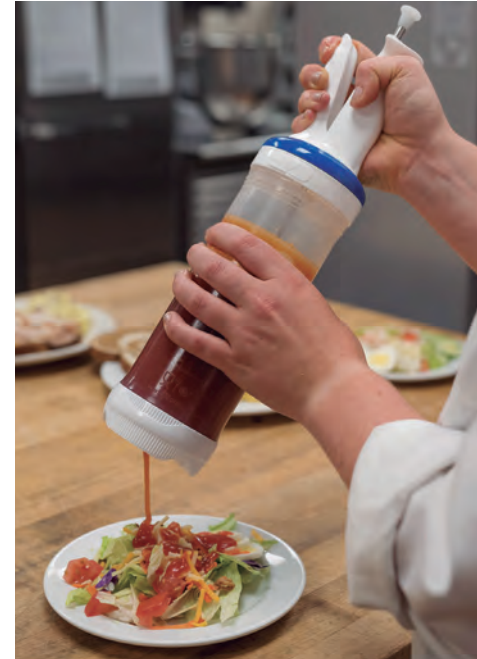

FB-PP16-BOTTLE-6

Pack de 6 - Bouteille
pour FB-PP16, valve incluse
500 ml



FB-PP24-BOTTLE-6

Pack de 6 - Bouteille
pour FB-PP24, valve incluse
8,2 cm de Ø x 21,3 cm haut.
710 ml



FB-PH116-1

Poignée pour FB-PP16



FB-PH124-1

Poignée pour FB-PP16

8,5 cm de Ø x 26 cm haut.



FB-PP1H-6

Bouchon distributeur,
une seule valve
8,2 cm de Ø x 2,8 cm haut.



FB-PP2H-6

Bouchon distributeur à deux
valves



FB-PP3H-6

Bouchon distributeur à trois
valves



Tous les prix sont indiqués en P.V.P. unitaire.

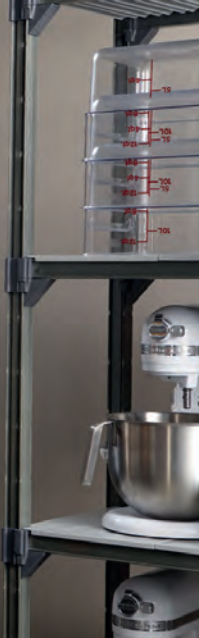

■ Pelles et verres doseurs

Fabriqués en polycarbonate pratiquement incassables, les verres doseurs gradués et les pelles CAMBRO sont hygiéniques, faciles à nettoyer et très résistants.

25MCCW-135

Verre doseur
7 x 10 x 20 cm - 255 ml
🗑️ 12

50MCCW-135

Verre doseur
8 x 13 x 25 cm - 500 ml
🗑️ 12

100MCCW-135

Verre doseur
12 x 16 x 16 cm - 1 L
🗑️ 12

200MCCW-135

Verre doseur
14 x 19 x 44 cm - 2 L
🗑️ 12

400MCCW-135

Verre doseur
18 x 23 x 21 cm - 4 L
🗑️ 1



**Allergen
Free**

25MCCW-441

Verre doseur Allergen-Free
7 x 10 x 20 cm - 255 ml
🗑️ 12
Transparent, texte violet

50MCCW-441

Verre doseur Allergen-Free
8 x 13 x 25 cm - 500 ml
🗑️ 12
Transparent, texte violet

100MCCW-441

Verre doseur Allergen-Free
12 x 16 x 16 cm - 1 L
🗑️ 12
Transparent, texte violet



200MCCW-441

Verre doseur Allergen-Free
14 x 19 x 44 cm - 2 L
🗑️ 12
Transparent, texte violet

400MCCW-441

Verre doseur Allergen-Free
18 x 23 x 21 cm - 4 L
🗑️ 1
Transparent, texte violet



Tous les articles en **gras** sont des produits de stock habituel. Consulter les couleurs disponibles.



■ Verres doseurs en silicone

Le design à trois faces permet une bonne prise de ces verres doseurs rendant les versements faciles et sûrs. Les mesures sont imprimées dans des cups, onces et millilitres. Aptes au micro-ondes.

HSMC3

Set de 3 verres doseurs

250 ml

500 ml

1 L



SCP6CW

Pelle en polycarbonate

16 x 6 x 6,5 cm

170 gr



SCP12CW

Pelle en polycarbonate

27 x 7,5 x 7 cm

340 gr



SCP24CW

Pelle en polycarbonate

17 x 17,3 cm

680 gr



SCP64CW

Pelle en polycarbonate

17 x 17,3 cm

1.814 gr



Tous les prix sont indiqués en P.V.P. unitaire.



■ Passoires en maille



94



84



1022



1023

94
Passoire à maille simple et manche en bois. Maille fine de 20 cm
20 cm de Ø

🗑️ 6



84
Passoire à maille double et manche en bois. Maille fine de 20 cm
20 cm de Ø

🗑️ 6



87
Passoire à maille double et manche en bois. Maille fine de 26 cm
26 cm de Ø

🗑️ 6



96
Passoire à maille double et manche en bois. Maille moyenne de 16 cm
16 cm de Ø

🗑️ 6



98
Passoire à maille double et manche en bois. Maille moyenne de 20 cm
20 cm de Ø

🗑️ 6



99
Passoire à maille double et manche en bois. Maille fine de 26 cm
26 cm de Ø

🗑️ 6



1021
Passoire renforcée et manche plat en bois. Maille double moyenne de 22 cm
22 cm de Ø

🗑️ 1



1022
Passoire renforcée et manche plat en bois. Maille double moyenne de 26 cm
26 cm de Ø

🗑️ 1



1023
Passoire renforcée et manche rond en bois. Maille double moyenne de 30 cm
30 cm de Ø

🗑️ 1



1024
Passoire renforcée et manche rond en bois. Maille double moyenne de 35 cm
35 cm de Ø

🗑️ 1



348
Passoire conique
18 cm de Ø - 2,3 L

🗑️ 1

● INOX.

Tous les articles en **gras** sont des produits de stock habituel. Consulter les couleurs disponibles.

Pinces antimicrobiennes

Parfaites pour servir la portion adéquate. Pinces antimicrobienne Microban® au toucher froid pour une utilisation sûre et hygiénique, réduisant le risque de contamination.



AM3774

Pince antimicrobienne recouverte en vinyle

24,4 x 3,8 x 3,5 cm

12

● BK ● BL ● G ● R ● Y



AM3712

Pince antimicrobienne recouverte en vinyle

31,4 x 1,9 x 3,8 cm

12

● BK ● BL ● G ● R ● Y



AM3716

Pince antimicrobienne recouverte en vinyle

41,3 x 3,8 x 4,4 cm

12

● BK ● BL ● G ● R ● Y

Pinces en acier inoxydable recouvertes en vinyle



3774BKEU

Pince recouverte en vinyle

24,4 x 3,8 x 3,5 cm

12

● BK



3774BLEU

Pince recouverte en vinyle

24,4 x 3,8 x 3,5 cm

12

● BL



3774GEU

Pince recouverte en vinyle

24,4 x 3,8 x 3,5 cm

12

● G



3774REU

Pince recouverte en vinyle

24,4 x 3,8 x 3,5 cm

12

● R



3774YEU

Pince recouverte en vinyle

24,4 x 3,8 x 3,5 cm

12

● Y

3712BKEU

Pince recouverte en vinyle

31,4 x 1,9 x 3,8 cm

12

● BK

3712BLEU

Pince recouverte en vinyle

31,4 x 1,9 x 3,8 cm

12

● BL

3712GEU

Pince recouverte en vinyle

31,4 x 1,9 x 3,8 cm

12

● G

3712REU

Pince recouverte en vinyle

31,4 x 1,9 x 3,8 cm

12

● R

3712YEU

Pince recouverte en vinyle

31,4 x 1,9 x 3,8 cm

12

● Y

3716BKEU

Pince recouverte en vinyle

41,3 x 3,8 x 4,4 cm

12

● BK

3716BLEU

Pince recouverte en vinyle

41,3 x 3,8 x 4,4 cm

12

● BL

3716GEU

Pince recouverte en vinyle

41,3 x 3,8 x 4,4 cm

12

● G

3716REU

Pince recouverte en vinyle

41,3 x 3,8 x 4,4 cm

12

● R

3716YEU

Pince recouverte en vinyle

41,3 x 3,8 x 4,4 cm

12

● Y

Tous les prix sont indiqués en P.V.P. unitaire.



■ Pince-commandes

5512

Pince-commande
30,5 cm



2

● AL

5518

Pince-commande
45,5 cm



2

● AL

5524

Pince-commande
61 cm



2

● AL

5536

Pince-commande
91,5 cm



2

● AL

5548

Pince-commande
122 cm



2

● AL

5560

Pince-commande
152,5 cm



2

● AL

■ Embouts

5

Set de 5 embouts de 5, 7,5,
10, 13 y 15 cm
15 cm de Ø x 17 cm haut.



6



■ Passoires rigides



705

Passoire à poignées
29 cm de Ø x 11,5 cm
haut. - 4,8 L



1

● INOX.

708

Passoire à poignées
35 cm de Ø x 13 cm
haut. - 7,6 L



1

● INOX.

713

Passoire à poignées
41,5 cm de Ø x 15 cm
haut. - 12,4 L



1

● INOX.



Tous les articles en **gras** sont des produits de stock habituel. Consulter les couleurs disponibles.

Bols de mélanges

Choisissez parmi les bols standards en acier inoxydable 0,4 mm ou de qualité supérieure en acier inoxydable 0,8 mm chacun avec aspect miroir. Grande variété de tailles pour faciliter le travail dans la cuisine.



822

Bol de mélanges standard
16,5 cm de Ø x 5 cm
haut. - 0,7 L



INOX.

823

Bol de mélanges standard
19 cm de Ø x 6 cm
haut. - 1,4 L



INOX.

824

Bol de mélanges standard
24 cm de Ø x 7,5 cm
haut. - 2,9 L



INOX.



825

Bol de mélanges standard
27 cm de Ø x 9 cm
haut. - 3,8 L



INOX.

826

Bol de mélanges standard
29 cm de Ø x 10 cm
haut. - 4,8 L



INOX.

827

Bol de mélanges standard
35 cm de Ø x 11,5 cm
haut. - 7,6 L



INOX.

828

Bol de mélanges standard
40,5 cm de Ø x 13 cm
haut. - 12,4 L



INOX.

830

Bol de mélanges standard
47 cm de Ø x 14,5 cm
haut. - 19 L



INOX.

H826

Bol de mélanges
Qualité supérieure
29,5 cm de Ø x 9,2 cm
haut. - 4,8 L



INOX.

H827

Bol de mélanges
Qualité supérieure
34,9 cm de Ø x 10,8 cm
haut. - 7,6 L



INOX.

H828

Bol de mélanges
Qualité supérieure
41,3 cm de Ø x 12,7 cm
haut. - 12,4 L



INOX.

H829

Bol de mélanges
Qualité supérieure
46,7 cm de Ø x 14,3 cm
haut. - 15,2 L



INOX.



Pelles

Nos pelles à frites sont résistantes à la chaleur, au sel et à la graisse.



FFR8

Pelle à frites à manche à droite
22,2 x 23,5 x 5,7 cm



INOX. ●



FFD8

Pelle à frites à double manche
22,9 x 23,5 x 5,7 cm



INOX. ●



PR8

Pelle à frites en plastique à manche à droite
23,5 x 20,6 x 4,9 cm



INOX. ○



PD8

Pelle à frites en plastique à double manche
23,5 x 20,6 x 4,9 cm



INOX. ○

Tous les prix sont indiqués en P.V.P. unitaire.



Pizza screen

Peut être utilisé en toute sécurité en four jusqu'à 232 °C. Obtenez une pâte à pizza parfaite.

PS13

Base en aluminium
pour pizza 33 cm de Ø

12

AL

123569

Base en aluminium
pour pizza 45,5 cm de Ø

12

AL

123570

Base en aluminium
pour pizza 50,5 cm de Ø

12

AL



Articles qui peuvent vous intéresser...



Plats à pizza en fonte d'aluminium



Boîte à pâtons en polyéthylène



Plats à pizzas pour le four



Découpe pizza

Tous les articles en **gras** sont des produits de stock habituel. Consulter les couleurs disponibles.

Cuillères

3715

Cuillère de service
38 cm de long

🍴 12

● INOX.



2068

Cuillère à pasta
29 cm de long

🍴 6

● INOX.



6702

Louche à sauce "spoonout"
26,5 cm de long - 60 ml

🍴 12

● INOX. ●



6703

Louche à sauce "spoonout"
26,5 cm de long - 90 ml

🍴 12

● INOX. ●



6704

Louche à sauce "spoonout"
26,5 cm de long - 118 ml

🍴 12

● INOX. ●



6705

Louche à sauce "spoonout"
26,5 cm de long - 148 ml

🍴 12

● INOX. ●



6706

Louche à sauce "spoonout"
26,5 cm de long - 177 ml

🍴 12

● INOX. ●



6708

Louche à sauce "spoonout"
26,5 cm de long - 237 ml

🍴 12

● INOX. ●



7704

Louche perforée "spoonout"
26,5 cm de long - 118 ml

🍴 12

● INOX. ●



Tous les prix sont indiqués en P.V.P. unitaire.

Cuillères à glace

Parfaites pour le contrôle des rations.



2116

Cuillère à glace à gachette au pouce

21,5 x 8,5 x 4,5 cm - 16 a 78 gr

6

INOX. ●



2120

Cuillère à glace à gachette au pouce

21 x 8,5 x 4 cm - 20 a 57 gr

6

INOX. ●



2124

Cuillère à glace à gachette au pouce

20,5 x 8 x 4 cm - 24 a 50 gr

6

INOX. ●



2130

Cuillère à glace à gachette au pouce

22 x 9 x 4,5 cm - 30 a 35 gr

6

INOX. ●

Cuillères en bois



W12

Cuillère en bois

30,5 x 7,6 x 1,3 cm

12

● N

W14

Cuillère en bois

35,6 x 7,6 x 1,3 cm

12

● N

W16

Cuillère en bois

40,6 x 7,6 x 1,3 cm

12

● N

W18

Cuillère en bois

45,7 x 7,6 x 1,3 cm

12

● N

Rejoignez-nous



@DbmarkTweet



@dbmarkhosteleria



@dbmark_inst

Tous les articles en **gras** sont des produits de stock habituel. Consulter les couleurs disponibles.

Fouets

Fouets en acier inoxydable de différentes tailles. Existe en modèle extra-long à bouillir tout en battant sans se brûler.



SF10

Fouet, fils en acier inoxydable
26 x 7 x 7 cm



INOX.

SF12

Fouet, fils en acier inoxydable
6,4 x 6,4 x 30,5 cm



INOX.

SF14

Fouet, fils en acier inoxydable
35,6 x 7 x 7 cm



INOX.

SF16

Fouet, fils en acier inoxydable
40,6 x 7,6 x 7,6 cm



INOX.

SF18

Fouet, fils en acier inoxydable
45,7 x 7,6 x 7,6 cm



INOX.

SF20

Fouet, fils en acier inoxydable
50,8 x 2,5 x 2,5 cm



INOX.

SF24

Fouet, fils en acier inoxydable
61 x 8,9 x 8,9 cm



INOX.



SP10

Fouet, fils en acier inoxydable
25,5 cm de long



INOX.

SP12

Fouet, fils en acier inoxydable
30 cm de long



INOX.

SP14

Fouet, fils en acier inoxydable
35,5 cm de long



INOX.

SP16

Fouet, fils en acier inoxydable
40,5 cm de long



INOX.



MW40

Fouet extra long
101,6 x 12,7 x 12,7 cm



INOX.

Tous les prix sont indiqués en P.V.P. unitaire.

Spatules

Des ustensiles de qualité supérieure pour mener le travail dans cuisine de manière professionnelle et très performante.



2003

Spatule à poisson et manche en bois

15 cm de long

12

INOX.



4100S

Spatule à lame arrondie et manche en bois

37 cm - lame de 9 cm

12

INOX.



451

Spatule renforcée à lame carrée et manche en bois

33 cm - lame de 13 x 16 cm

12

INOX.



461W

Spatule solide, lame carrée et manche en ABS

28 cm - lame de 11,5 x 16 cm

12

INOX.



251W

Spatule solide, lame carrée et manche en ABS

29 cm - lame de 13 cm

12

INOX.



254

Raclette et manche en bois

20 cm - lame de 10 cm

12

INOX.



253W

Raclette et manche ABS

24 cm - lame de 7,5 cm

12

INOX.



4103W

Raclette et prise ABS

15 cm de long

12

INOX.



242

Spatule et manche en bois

25,5 cm de long

12

INOX.



242W

Spatule et manche de ABS

28 cm de long

12

INOX.

Tous les articles en **gras** sont des produits de stock habituel. Consulter les couleurs disponibles.



■ Spatules - Collection Contemporary

Les spatules de la collection Contemporary sont dotées de poignées ergonomiques qui fournissent une prise sûre et confortable. Fabriquées en plastique résistant à la chaleur, restent froides pendant l'utilisation. Les lames sont en acier inoxydable de haute qualité pour répondre aux exigences de la cuisine.



251BKEU

Spatule solide et manche ergonomique et lame carrée
29 cm - lame de 12,5 cm

🛒 12

● INOX.



461BKEU

Spatule solide et manche ergonomique et lame carrée
28 cm - lame de 11,5 x 16 cm

🛒 12

● INOX.



242BKEU

Spatule et manche ergonomique
28 cm de long

🛒 12

● INOX.



253BKEU

Raclette et manche ergonomique
24 cm - lame de 7,5 cm

🛒 12

● INOX.



4104BKEU

Pelle de tartiner et manche ergonomique

24 cm de long

🛒 12

● INOX.



4100PBKEU

Spatule perforée, manche ergonomique et lame arrondie

38 cm - lame de 17,5 cm

🛒 12

● INOX.



4100BKEU

Spatule solide, manche ergonomique et lame arrondie

38 cm - lame de 17,5 cm

🛒 12

● INOX.

Tous les prix sont indiqués en P.V.P. unitaire.

Couteaux spatules de pâtisserie



4206

Couteau spatule
et manche de ABS

15 x 2,5 cm (lame)
28,5 x 3,2 cm (manche
inclus)

12

INOX.

4208

Couteau spatule
et manche de ABS

20 x 2,5 cm (lame)
33,7 x 3,2 cm (manche
inclus)

12

INOX.



4210

Couteau spatule
et manche de ABS

25,5 cm (lame)
39,4 x 3,5 cm (manche
inclus)

12

INOX.

4212

Couteau spatule
et manche de ABS

30 cm (lame)
43,8 x 4,5 cms (manche
inclus)

12

INOX.

4214

Couteau spatule
et manche de ABS

35,5 cm (lame)
48,3 x 4,1 cm (manche
inclus)

12

INOX.

Cuillères et tasses doseuses



722

Set de cuillères doseuses :
0,25/0,5/1 cuillère/1 cuillère

13,3 x 4,4 x 1,9 cm

6

INOX.



724

Set de tasses doseuses :
0,25/0,3/0,5/1 tasse

15,2 x 8,8 x 6,3 cm

6

INOX.



724A

Tasse doseuse 0,25

11,5 x 5,5 x 3 cm

6

INOX.



725

Set de tasses doseuses :
0,25/0,3/0,5/1 tasse - qualité
supérieure

8,2 x 6,3 x 17,7 cm

6

INOX.

Rejoignez-nous



@DbmarkTweet



@dbmarkhosteleria



@dbmark_inst

Tous les articles en **gras** sont des produits de stock habituel. Consulter les couleurs disponibles.



Spatules Maryse

Ustensiles résistants à haute température (jusqu'à 260 °C) avec manche en nylon et lame de silicone ou en caoutchouc. Apte au lavage au lave-vaisselle.

jusqu'à 60° C



1500

Spatule Maryse
24 cm de long

🗑️ 12

○ WH



1510

Spatule Maryse
25,5 cm de long

🗑️ 12

○ WH



1514

Spatule Maryse
35,5 cm de long

🗑️ 12

○ WH



1516

Spatule Maryse
40,5 cm de long

🗑️ 12

○ WH

2510

Spatule Maryse type cuillère
24 cm de long

🗑️ 12

○ WH

2514

Spatule Maryse type cuillère
34 cm de long

🗑️ 12

○ WH

2516

Spatule Maryse type cuillère
42 cm de long

🗑️ 12

○ WH



Tous les prix sont indiqués en P.V.P. unitaire.

■ Spatules Maryse (suite)



1862

Spatule Maryse haute température à encoche

26,5 cm de long



○ WH

1863

Spatule Maryse haute température à encoche

35,5 cm de long



○ WH

1864

Spatule Maryse haute température à encoche

41,5 cm de long



○ WH



■ jusqu'à 260° C

1865

Spatule Maryse haute température type cuillère

26,5 cm de long



○ WH

1866

Spatule Maryse haute température type cuillère

35,5 cm de long



○ WH

1867

Spatule Maryse haute température type cuillère

41,5 cm de long



○ WH



■ jusqu'à 260° C

■ Presses-purées



7412

Presse-purée avec manche en acier et presse losange

30 cm de long



● INOX.



7418

Presse-purée avec manche en acier et presse carrée

46 cm de long



● INOX.



4424

Presse-purée avec manche en acier et presse ronde

61 cm de long



● INOX.



7319

Presse-purée avec manche chromée et presse ronde

48 cm de long



● INOX.



7324

Presse-purée avec manche chromée et presse ronde

61 cm de long



● INOX.



■ Écumoires



2409

Écumoire nickelé en spirale

23 cm de long



3306

Écumoire nickelé à maille carrée

15 cm de long



2675

Écumoire rectangulaire à maille fine

16,5 cm de long



2677

Écumoire carré à mailles fine

16,5 cm de long



Tous les articles en **gras** sont des produits de stock habituel. Consulter les couleurs disponibles.

Panier de cuisine



985

Panier à pâtes et manche froid

13 x 13 x 18 cm



986

Panier à pâtes et manche froid

16,5 x 16,5 x 18 cm

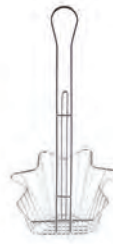

44060

Panier incliné à tacos

21 x 20 x 12,5 cm



44080

Panier incliné à tacos

19 x 12,5 x 12,5 cm



41

Panier et manche froid pour 17 toasts

45,5 x 16,5 x 20,5 cm



40

Panier et manche froid pour 8 tacos

32 x 16,5 x 8 cm



42

Panier rectangulaire à friture et manche en vinyle vert

34 x 16,5 x 15 cm

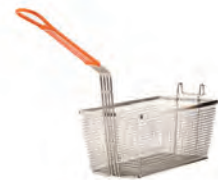

43

Panier rectangulaire à friture et manche en vinyle orange

30,5 x 16 x 13,5 cm



426

Panier rectangulaire à friture et manche en vinyle noir

28 x 13,5 x 10 cm



428

Panier rectangulaire à friture et manche en vinyle bleu

33,5 x 14,5 x 14 cm



TB1164

Panier à friture pour burritos et manche en vinyle rouge

55,9 x 17,8 x 26,7 cm



TB60

Panier à friture pour 4 tacos et manche en vinyle rouge

56,5 x 16,5 x 19,4 cm



Tous les prix sont indiqués en P.V.P. unitaire.



■ Ustensiles Firm Grip

La collection Firm Grip est composée des poignées ergonomiques douces antidérapantes qui offrent une prise en main sûre et confortable. Les lames sont en acier inoxydable de haute qualité pour répondre aux exigences de la cuisine.



E5601

Éplucheur droit à lame lisse

18,4 x 2,5 x 1,9 cm

12

● INOX. ●



E5602

Éplucheur en Y à lame lisse

14,6 x 7 x 3,2 cm

12

● INOX. ●



E5602-JU

Éplucheur en Y à lame julienne

14,6 x 7 x 2,5 cm

12

● INOX. ●



E5602-SE

Éplucheur en Y à lame dentelée

2,9 x 7 x 14,6 cm

12

● INOX. ●



E5609

Coupeur double de pasta

15,9 x 6,7 x 2,5 cm

12

● INOX. ●



E5698

Aigüiseur

26,4 x 10,2 x 2,9 cm

12

● INOX. ●



E5607

Évideur de tomate

15,9 x 2,9 x 2,5 cm

12

● INOX. ●



E5604

Éplucheur de citron

2,9 x 2,2 x 14,6 cm

12

● INOX. ●



E5606

Évideur de pomme

21 x 2,5 x 1,9 cm

12

● INOX. ●



E5605

Évideur de fruit

17,8 x 2,9 x 1,9 cm

12

● INOX. ●

Tous les articles en **gras** sont des produits de stock habituel. Consulter les couleurs disponibles.

Ustensiles Firm Grip (suite)



E5629

Ouvre huitres
5,9 x 4,1 x 15,2 cm

12

INOX.



E5618

Couteau à éplucher
19,4 x 1,9 x 1,6 cm

12

INOX.



E5630

Spatule à rainures
4,1 x 4,8 x 21,6 cm

12

INOX.



E5603

Pelle à fromage
21,6 x 7,3 x 3,8 cm

12

INOX.



E5614

Presse-ail
17,2 x 3,5 x 5,5 cm

12

INOX.



E5619

Cuillère à glace
20,3 x 4,6 x 2,8 cm

12

INOX.



E5627

Ouvre boîte
20,3 x 5,7 x 4,5 cm

12

INOX.



E5626

Roulette à pizza
20,3 x 10,2 x 1,9 cm

12

INOX.



E5616

Râpe trous moyens
24,1 x 5,4 x 2,2 cm

12

INOX.



E5617

Râpe trous larges
23,8 x 5,4 x 2,2 cm

12

INOX.



E5615

Râpe trous petits
22,9 x 5,4 x 2,2 cm

12

INOX.



E5632

Râpe étroit
34,9 x 3,8 x 2,2 cm

12

INOX.



E6606

Ciseaux de cuisine
21,3 x 8,6 x 1,3 cm

12

INOX.



E6607

Ciseaux à poulet
24,1 x 6,7 x 2,5 cm

12

INOX.

Tous les prix sont indiqués en P.V.P. unitaire.



Ustensiles variés

De l'ouvre-boîte aux marteaux attendrisseur de viande, nous vous présentons des outils de haute qualité pour faciliter le travail en cuisine.



3005
Marteau attendrisseur
de viande

25,5 x 6,5 x 7 cm



3016
Marteau attendrisseur
de viande, manche en
bois

33 x 7 x 7,5 cm



SG200
Râpe

7,5 x 10 x 23 cm



1240
Anneaux à oeufs
antiadhérents

25,5 x 39,5 x 9,5 cm



3004
Presse à viande

21 x 11 x 4 cm



3033
Presse à viande

21 x 11 x 6,5 cm



H5001
Éplucheur de maïs

16,2 x 6,2 x 1,9 cm



H6610
Hachoir berceuse lame
dentelée simple

1,9 x 19,1 x 12,7 cm



● INOX.



H6611
Hachoir berceuse lame
simple

19,1 x 2,2 x 12,7 cm



● INOX.



H6622
Hachoir berceuse
de double lame

18,4 x 2,2 x 13,3 cm



● INOX.

Tous les articles en **gras** sont des produits de stock habituel. Consulter les couleurs disponibles.

Ustensiles variés (suite)



4106W

Roulette à pizza

10 cm de long

🗑️ 12

● INOX.



RG-161

Grattoir grill petit

38 x 16,5 x 11,5 cm

🗑️ 1



RG-173

Grattoir grill petit

27 x 12 x 9 cm

🗑️ 1



RG-181

Grattoir grill lame en caoutchouc

36 x 15 x 14,5 cm

🗑️ 1

Distributeur de rouleaux en plastique et aluminium

- L'évolution de l'hygiène, de la sécurité et du style.
- Permet d'utiliser 100% du rouleau plastique ou aluminium.
- Comprend des poignées pour faciliter le transport.
- Apte au lavage au lave-vaisselle.
- Avec un design moderne pour le porter dans la salle à manger ou cuisine ouverte.



KK3

Distributeur de rouleaux

55,9 x 19,4 x 16,5 cm

🗑️ 1



RWS12

Distributeur de rouleaux

41,9 x 25,1 x 23,5 cm

🗑️ 1

Pièces de rechange

KK3SRB

Lame de rechange pour KK3

49,2 x 1 x 2,5 cm

🗑️ 1

KK3SRB2

Paquet de 2 lames de rechange pour KK3

49,2 x 1 x 2,5 cm

🗑️ 1

RB2

Lame de sécurité en métal pour KK3

45,7 x 1 x 1 cm

🗑️ 1



Planches à découper

Utilisez les planches à découper codées avec l'une des 6 couleurs pour réduire les risques de contamination croisée dans la cuisine. Nous vous proposons deux épaisseurs différentes. La planche de 1,4 mm est souple et très utile pour certaines tâches de cuisine. Nous vous proposons également des gants de coupe, fabriqués en textile résistant au tranchant des couteaux et disponibles en différentes couleurs. Lavables au lave-vaisselle.



FCB1218A

Planches à découper souples, assortiment de couleurs
45,7 x 30,5 x 0,14 cm



Surtido de colores

CB912WA

Planche à découper, épaisseur 1,3 cm
22,9 x 30,5 x 1,3 cm



CB1218BLA

Planche à découper, épaisseur 1,3 cm
45,7 x 30,5 x 1,3 cm



CB1218BRA

Planche à découper, épaisseur 1,3 cm
45,7 x 30,5 x 1,3 cm



CB1218GNA

Planche à découper, épaisseur 1,3 cm
45,7 x 30,5 x 1,3 cm



CB1218RA

Planche à découper, épaisseur 1,3 cm
45,7 x 30,5 x 1,3 cm



CB1218WA

Planche à découper, épaisseur 1,3 cm
30,5 x 45,7 x 1,3 cm



CB1218YA

Planche à découper, épaisseur 1,3 cm
45,7 x 30,5 x 1,3 cm



CB1824BLA

Planche à découper, épaisseur 1,3 cm
61 x 45,7 x 1,3 cm



CB1824BRA

Planche à découper, épaisseur 1,3 cm
61 x 45,7 x 1,3 cm



CB1824GNA

Planche à découper, épaisseur 1,3 cm
61 x 45,7 x 1,3 cm



CB1824RA

Planche à découper, épaisseur 1,3 cm
61 x 45,7 x 1,3 cm



CB1824WA

Planche à découper, épaisseur 1,3 cm
61 x 45,7 x 1,3 cm



CB1824YA

Planche à découper, épaisseur 1,3 cm
61 x 45,7 x 1,3 cm



Rejoignez-nous



@DbmarkTweet



@dbmarkhosteleria



@dbmark_inst

Tous les articles en **gras** sont des produits de stock habituel. Consulter les couleurs disponibles.

Planches à découper coins antidérapants

Grâce à sa variété de couleurs, le risque de contamination croisée est réduit. Les coins antidérapants en silicone assurent une grande stabilité. Hygiéniques, faciles à nettoyer et avec une poignée intégrée pour plus de confort.



CBG1218AWH

Planches à découper coins antidérapants

45,5 x 30,5 x 1,3 cm



CBG1218AGN

Planches à découper coins antidérapants

45,5 x 30,5 x 1,3 cm



CBG1218ARD

Planches à découper coins antidérapants

45,5 x 30,5 x 1,3 cm



CBG1218AYL

Planches à découper coins antidérapants

45,5 x 30,5 x 1,3 cm



CBG1218ABL

Planches à découper coins antidérapants

45,5 x 30,5 x 1,3 cm



CBG1218ABR

Planches à découper coins antidérapants

45,5 x 30,5 x 1,3 cm



CBG1520AWH

50 x 38 x 1,3 cm



CBG1520AGN

50 x 38 x 1,3 cm



CBG1520ARD

50 x 38 x 1,3 cm



CBG1520AYL

50 x 38 x 1,3 cm



CBG1520ABL

50 x 38 x 1,3 cm



CBG1520ABR

50 x 38 x 1,3 cm



CBG1824AWH

61 x 45,5 x 1,3 cm



CBG1824AGN

61 x 45,5 x 1,3 cm



CBG1824ARD

61 x 45,5 x 1,3 cm



CBG1824AYL

61 x 45,5 x 1,3 cm



CBG1824ABL

61 x 45,5 x 1,3 cm



CBG1824ABR

61 x 45,5 x 1,3 cm



W



GN



R



Y



BL



BR



Accédez aux principaux outils de Cambro

L'application Cambro vous donne instantanément accès aux principaux outils et aux ressources de Cambro.

De la personnalisation d'un plateau jusqu'à la découverte de la gamme complète de conteneurs de Cambro.

<https://www.cambro.com/app/>



Tous les prix sont indiqués en P.V.P. unitaire.

■ Planches à découper (suite)



CBR6

Support avec séparateurs pour 6 planches
31 x 24 x 25,5 cm

🗑️ 10

● INOX.



CBR6BK*

Support avec séparateurs et crochets pour 6 planches
30,8 x 24,1 x 25,4 cm

🗑️ 10

● BK

*Cepillos y tablas no incluidos.



WSC12

Support avec séparateurs pour 6 planches
26,4 x 34,3 x 26,7 cm

🗑️ 10

● INOX.



TK94433

Gant de protection anti-coupure taille M.
30 x 15 x 1 cm

🗑️ 1

●



TK94443

Gant de protection anti-coupure taille M.
30 x 15 x 1 cm

🗑️ 1

●



TK94453

Gant de protection anti-coupure taille M.
30 x 15 x 1 cm

🗑️ 1

●

■ Saupoudreuses et pots à condiments

Articles de base dans la cuisine ou sur la table. En polycarbonate transparent, aluminium ou acier inoxydable. Les saupoudreuses en polycarbonate ont des couvercles codés par couleur pour faciliter l'identification du contenu, les pots à condiments un couvercle avec encoche pour la cuillère de service.



96SKRP-135

Saupoudreuse avec couvercle à persil
10,9 x 8 x 9,6 cm - 300 ml

🗑️ 12

○ 135



96SKRD-135

Saupoudreuse avec couvercle à sel et poivre
10,9 x 8 x 9,6 cm - 300 ml

🗑️ 12

○ 135



96SKRC-135

Saupoudreuse avec couvercle à fromage
10,9 x 8 x 9,6 cm - 300 ml

🗑️ 12

○ 135



96SKRM-135

Saupoudreuse avec couvercle à poudre moyenne
10,9 x 8 x 9,6 cm - 300 ml

🗑️ 12

○ 135

Tous les articles en **gras** sont des produits de stock habituel. Consulter les couleurs disponibles.

■ Saupoudreuses et pots à condiments (suite)



96SKRLP-148

Couvercle de rechange à persil

8,8 x 8 x 0,9 cm

🗑️ 12

○ 148



96SKRLD-406

Couvercle de rechange à sel et poivre

8,8 x 8 x 0,9 cm

🗑️ 12

● 406



96SKRLC-405

Couvercle de rechange à fromage

8,8 x 8 x 0,9 cm

🗑️ 12

● 405



96SKRLM-408

Couvercle de rechange à poudre moyenne

8,8 x 8 x 0,9 cm

🗑️ 12

● 408



CJ80CW-135

Jeu de pots à condiments

8,3 cm de Ø x 10,2 cm haut. - 240 ml

🗑️ 24

○ 135



H158

Saupoudreuse à anse

8,9 x 6,6 x 8,9 cm - 295 ml

🗑️ 12

● AL



H159

Saupoudreuse à anse

9,5 x 7 x 9,5 cm - 295 ml

🗑️ 12

● INOX.



159

Saupoudreuse sans anse

7 x 7 x 9,5 cm - 295 ml

🗑️ 12

● INOX.



Tous les prix sont indiqués en P.V.P. unitaire.

Bacs GN haute température H-Pans

Le leader mondial dans les bacs GN en polycarbonate vous offre également la plus large gamme de bacs GN à haute température. Fabriqués dans un matériau très résistant, il supporte des températures allant jusqu'à 190 °C. Utilisez le même récipient pour cuisiner, stocker, régénérer et présenter les aliments. Parfait pour une utilisation au micro-ondes, au bain marie ou toutes zones de présentation chaudes.



jusqu'à 190 °C

Aptes usage au
**micro-ondes
et bain-marie**



Disponible en deux couleurs
ambre et noir

GN 1/1 - 32,5 x 53 cm

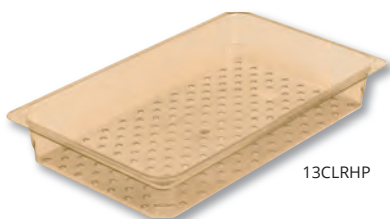

13CLRHP

10HPCH

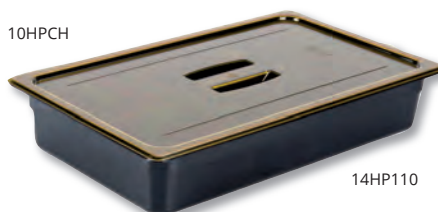

14HP110



10HPD-150



12HPH-150

Bac GN 1/1 - 32,5 x 53 cm

Code	Description	Couleurs	UE
12HP	6,5 cm prof. - 8,5 L	110 ■ 150 ■	6
14HP	10 cm prof. - 13 L	110 ■ 150 ■	6
16HP	15 cm prof. - 19,5 L	110 ■ 150 ■	6
10HPD	Égouttoir	150 ■	6

Bac avec poignées GN 1/1 - 32,5 x 53 cm

12HPH	6,5 cm prof. - 8,42 L	150 ■	6
--------------	-----------------------	-------	---

Bac égouttoir GN 1/1 - 32,5 x 53 cm

13CLRHP	7,6 cm prof.	150 ■	6
15CLRHP	12,7 cm prof.	150 ■	6

Couvercle GN 1/1 - 32,5 x 53 cm

10HPC	Plat	150 ■	6
10HPCH	Avec poignée	150 ■	6
10HPCHN	À encoche et poignée	150 ■	6

Tous les articles en **gras** sont des produits de stock habituel. Consulter les couleurs disponibles.



GN 1/2 long - 16,2 x 53 cm

Bac GN 1/2 long - 16,2 x 53 cm

Code	Description	Couleurs	UE
22LPHP	6,5 cm prof. - 3 L	110 ■ 150 ■	6
24LPHP	10 cm prof. - 5 L	110 ■ 150 ■	6
20LPHPD	Égouttoir	150 ■	6

Couvercle GN 1/2 long - 16,2 x 53 cm

20LPHPC	Plat	150 ■	6
----------------	------	-------	---

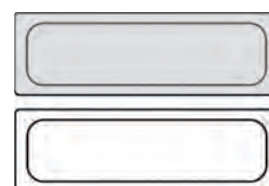

22LPHP-110



20LPHPD-150



20LPHPC-150

Bonnes pratiques

- Réduisez la manipulation du produit et minimisez les possibilités de contamination croisée en utilisant des produits qui peuvent accomplir plusieurs tâches à la fois.
- Décongeler en toute sécurité les viandes de bœuf et la volaille dans les récipients contenant des passoirs afin de séparer les jus des autres aliments.
- Refroidir rapidement les aliments chauds à des températures sûres de 21°C en moins de 2 heures et en dessous de 4 °C en moins de 4 heures.
- Diviser les aliments en récipients peu profonds de 6,5 cm pour un refroidissement plus rapide.
- Réchauffer les aliments à des températures sûres pendant au moins 15 secondes et dans les 2 heures.
- Ne pas décongeler les aliments à température ambiante ou les réchauffer au bain-marie (tables à vapeur).

Tous les prix sont indiqués en P.V.P. unitaire.

Bacs GN haute température

GN 1/2 - 26,5 x 32,5 cm



24HP-110



22HP-150



Bac GN 1/2 - 26,5 x 32,5 cm

Code	Description	Couleurs	UE
22HP	6,5 cm prof. - 3,9 L	110 ■ 150 ■	6
24HP	10 cm prof. - 5,9 L	110 ■ 150 ■	6
26HP	15 cm prof. - 8,9 L	110 ■ 150 ■	6
20HPD	Égouttoir	150 ■	6

Bac égouttoir GN 1/2 - 26,5 x 32,5 cm

23CLRHP	7,6 cm prof.	150 ■	6
25CLRHP	12,7 cm prof.	150 ■	6

Couvercle GN 1/2 - 26,5 x 32,5 cm

20HPC	Plat	150 ■	6
20HPCH	Avec poignée	150 ■	6
20HPCHN	À encoche et poignée	150 ■	6
20HPL	Basculant FlipLid	150 ■	6
20HPLN	FlipLid à encoche	150 ■	6



26HP-150

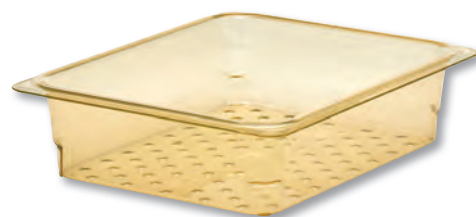

23CLRHP-150



Tous les articles en **gras** sont des produits de stock habituel. Consulter les couleurs disponibles.

Bacs GN haute température (suite)

GN 1/3 - 17,6 x 32,5 cm

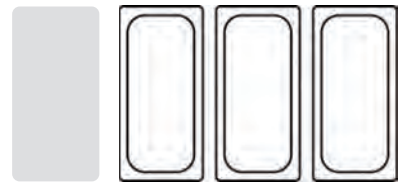

34HP-110

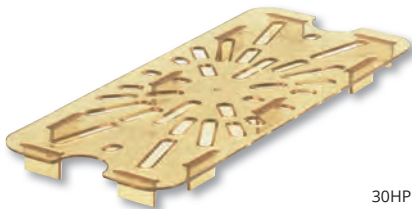

30HPD-150

Bac GN 1/3 - 17,6 x 32,5 cm

Code	Description	Couleurs	UE
32HP	6,5 cm prof. - 2,4 L	110 ■ 150 ■	6
34HP	10 cm prof. - 3,6 L	110 ■ 150 ■	6
36HP	15 cm prof. - 5,3 L	110 ■ 150 ■	6
30HPD	Égouttoir	150 ■	6

Bac égouttoir GN 1/3 - 17,6 x 32,5 cm

33CLRHP	7,6 cm prof.	150 ■	6
35CLRHP	12,7 cm prof.	150 ■	6

Couvercle GN 1/3 - 17,6 x 32,5 cm

30HPC	Plat	150 ■	6
30HPCH	Avec poignée	150 ■	6
30HPCHN	À encoche et poignée	150 ■	6
30HPL	Basculant FlipLid	150 ■	6
30HPLN	FlipLid à encoche	150 ■	6

GN 1/4 - 16,2 x 26,5 cm



46HP110



46HP-150



Bac GN 1/4 - 16,2 x 26,5 cm

Code	Description	Couleurs	UE
42HP	6,5 cm prof. - 1,7 L	110 ■ 150 ■	6
44HP	10 cm prof. - 2,5 L	110 ■ 150 ■	6
46HP	15 cm prof. - 3,7 L	110 ■ 150 ■	6
40HPD	Égouttoir	150 ■	6

Couvercle GN 1/4 - 16,2 x 26,5 cm

40HPC	Plat	150 ■	6
40HPCH	Avec poignée	150 ■	6
40HPCHN	À encoche et poignée	150 ■	6



Tous les prix sont indiqués en P.V.P. unitaire.

Bacs GN haute température (suite)

GN 1/6 - 16,2 x 17,6 cm



62HP-150



64HP-110



62HP-150



60HPD-150

Bac GN 1/6 - 16,2 x 17,6 cm

Code	Description	Couleurs	UE
62HP	6,5 cm prof. - 1 L	110 ■ 150 ■	6
64HP	10 cm prof. - 1,5 L	110 ■ 150 ■	6
66HP	15 cm prof. - 2,2 L	110 ■ 150 ■	6
60HPD	Égouttoir	150 ■	6

Bac égouttoir GN 1/6 - 16,2 x 17,6 cm

63CLRHP	7,6 cm prof.	150 ■	6
65CLRHP	12,7 cm prof.	150 ■	6

Couvercle GN 1/6 - 16,2 x 17,6 cm

60HPC	Plat	150 ■	6
60HPCH	Avec poignée	150 ■	6
60HPCHN	À encoche et poignée	150 ■	6
60HPL	Basculant FlipLid	150 ■	6
60HPLN	FlipLid à encoche	150 ■	6

GN 1/9 - 10,8 x 17,6 cm



92HP-110



94HP-150

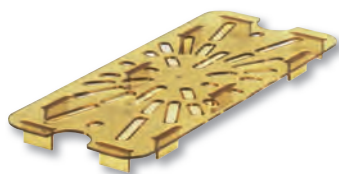

90HPD-150

Bac GN 1/9 - 10,8 x 17,6 cm

Code	Description	Couleurs	UE
92HP	6,5 cm prof. - 0,57 L	110 ■ 150 ■	6
94HP	10 cm prof. - 0,85 L	110 ■ 150 ■	6
90HPD	Égouttoir	150 ■	6

Couvercle GN 1/9 - 10,8 x 17,66 cm

90HPC	Plat	150 ■	6
--------------	------	-------	---

Tous les articles en **gras** sont des produits de stock habituel. Consulter les couleurs disponibles.

■ Bacs H-Pan haute température avec poignées



Bac avec poignées GN 1/3 - 17,6 x 32,5 cm

Code	Description	Couleurs	UE
32HP1H-150	Une poignée. 6,5 cm de prof.	150 ■	6
32HP2H-150	Deux poignées. 6,5 cm de prof.	150 ■	6
30HPD-150	Égouttoir	150 ■	6



32HP1H-150



32HP2H-150



30HPD

Bac avec poignées GN 1/1 - 32,5 x 53 cm

Code	Description	Couleurs	UE
12HPH-150	6,5 cm prof. - 8,42 L	150 ■	6



12HPH-150

Tous les prix sont indiqués en P.V.P. unitaire.



■ Tasses graduées Hautes températures

Les nouvelles tasses graduées haute température de Cambro sont les premières dans leur genre dans une innovation en matière de restauration. Ces verres doseurs ne se fissurent pas et ne se cassent pas lors d'une utilisation régulière. Le couvercle (en option) est auto-aéré et est conçu pour éviter les éclaboussures et les déversements qui peuvent se produire pendant le chauffage, laissant l'intérieur du micro-ondes ou du four propres.



200MCH

Tasse graduée
(no inclue couvercle)

22,9 x 16,2 cm - 2 L

🍵 1

● 150



400MCH

Tasse graduée
(no inclue couvercle)

23,2 x 26,3 cm - 4 L

🍵 1

● 150



MCCH

Couvercle anti-éclaboussures.
pour 200MCH y 400MCH

19 x 2,5 cm

🍵 1

● 150



Couvercle universel
anti-éclaboussures

Graduations moulées
en unités standard
et métriques



Résiste à des
températures comprises
entre -40° et 190 °C

Poignée moulée résistante
et reste froide au toucher
même après une utilisation
au four



Tous les articles en **gras** sont des produits de stock habituel. Consulter les couleurs disponibles.



■ Gants para alta température

Les gants haute température de TUCKER sont très appréciés par les professionnels de l'hôtellerie pour leur haute protection contre les brûlures. Non seulement, ils supportent les températures élevées des fourneaux, mais ils évitent les blessures à la vapeur, grâce à leur textile intérieur Vaporguard. Les gants Quickclean sont également très faciles à nettoyer. Utilisez les gants TUCKER pour prévenir les risques et éviter les accidents.



TK06150

Gant haute température moufle NOMEX

38 x 17 x 3 cm

👉 1



TK06180

Gant haute température moufle NOMEX

45 x 20 x 3 cm

👉 1



TK56152

Gant haute température moufle Quickclean Polycotton

38 x 17 x 3 cm

👉 1



TK56182

Gant haute température moufle Quickclean Polycotton

45 x 20 x 3 cm

👉 1



TK57782

Paire de gants haute température Quickclean 3 doigt en Kevlar

46 x 25 x 5 cm

👉 1



TK92203

Paire de gants haute température SteamGlove. Taille M

33 x 25 x 8 cm

👉 1



TK92204

Paire de gants haute température SteamGlove. Taille L

33 x 25 x 8 cm

👉 1



Tous les prix sont indiqués en P.V.P. unitaire.

■ Gants para alta température (suite)



TK05150

Gant haute température
NOMEX

38 x 17 x 4 cm



TK05180

Gant haute température
NOMEX

46 x 20 x 4 cm



TK55152

Gant haute température
Quickclean
Polycotton

38 x 17 x 4 cm



TK55182

Gant haute température
Quickclean
Polycotton

46 x 20 x 4 cm



TK05151

Gant haute température
NOMEX et Kevlar

38 x 17 x 4 cm



TK05181

Gant haute température
NOMEX et Kevlar

46 x 20 x 4 cm



TK88000

Manique haute température
carrée avec poche TerryCloth
20 x 19 x 1 cm



TK88500

Manique haute température
rectangulaire TerryCloth
25 x 20 x 1 cm



TK50362

Tablier haute température
Quickclean
18 x 20 x 5 cm



TK50422

Tablier haute température
Quickclean
18 x 20 x 5 cm



Rejoignez-nous



@DbmarkTweet



@dbmarkhosteleria



@dbmark_inst

Tous les articles en **gras** sont des produits de stock habituel. Consulter les couleurs disponibles.

Gamme GN en acier inoxydable pour le four



Les récipients Gastronorm en acier inoxydable sont fabriqués en acier 18/10 de différentes épaisseurs de 0,9 mm (2/1) à 0,6 mm (1/9) et aspect professionnelle mate. Conçus selon la norme GN EN-631, parfaits pour une utilisation en four à convection. Formats perforés (selon les tailles) et couvercles également disponibles.



GN 2/1 - 53 x 65 cm

Bac GN 2/1 - 53 x 65 cm

Code	Description	UE
GNP21020	2 cm prof. - 5,6 L	6
GNP21040	4 cm prof. - 11,7 L	6
GNP21065	6,5 cm prof. - 19,2 L	6
GNP21100	10 cm prof. - 29,5 L	6
GNP21150	15 cm prof. - 44,2 L	6
GNP21200	20 cm prof. - 59 L	6

Bac perforé GN 2/1 - 53 x 65 cm

Code	Description	UE
GPP21065	6,5 cm prof. - 19,2 L	6
GPP21100	10 cm prof. - 29,5 L	6
GPP21150	15 cm prof. - 44,2 L	6



GN 1/1 - 32,5 x 53 cm

Bac GN 1/1 - 32,5 x 53 cm

Code	Description	UE
GNP11020	2 cm prof. - 2,7 L	6
GNP11040	4 cm prof. - 5,6 L	6
GNP11055	5,5 cm prof. - 7 L	6
GNP11065	6,5 cm prof. - 9,1 L	6
GNP11100	10 cm prof. - 13,9 L	6
GNP11150	15 cm prof. - 20,8 L	6
GNP11200	20 cm prof. - 28 L	6

Bac perforé GN 1/1 - 32,5 x 53 cm

Code	Description	UE
GPP11020	2 cm - 2,7 L	6
GPP11040	4 cm - 5,6 L	6
GPP11065	6,5 cm - 9,1 L	6
GPP11100	10 cm - 13,9 L	6
GPP11150	15 cm - 20,8 L	6
GND11000	Fond perforé	6

Couvercle GN 1/1 - 32,5 x 53 cm

Code	Description	UE
GNL11000	Normal	6
GNLN11000	À encoche	6
GXL11000	Avec joint en silicone	6



Tous les prix sont indiqués en P.V.P. unitaire.

Gamme GN en acier inoxydable pour le four (suite)



GN 2/3 - 32,5 x 35,4 cm



Bac GN 2/3 - 32,5 x 35,4 cm

Code	Description	UE
GNP23020	2 cm prof. - 1,7 L	6
GNP23065	6,5 cm prof. - 5,8 L	6
GNP23100	10 cm prof. - 9,2 L	6
GNP23150	15 cm prof. - 13,3 L	6
GNP23200	20 cm prof. - 18,4 L	6
GND23000	Fond perforé	6

Couvercle GN 2/3 - 32,5 x 35,4 cm

Code	Description	UE
GNL23000	Normal	6

GN 2/4 - 53 x 16,2 cm

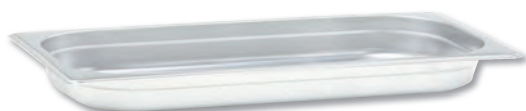

Bac GN 2/4 - 53 x 16,2 cm

Code	Description	UE
GNP24040	4 cm prof. - 2,4 L	6
GNP24065	6,5 cm prof. - 4 L	6
GNP24100	10 cm prof. - 6,2 L	6
GNP24150	15 cm prof. - 9,2 L	6

GN 1/2 - 26,5 x 32,5 cm



Bac GN 1/2 - 32,5 x 26,5 cm

Code	Description	UE
GNP12020	2 cm prof. - 1,2 L	6
GNP12040	4 cm prof. - 2,5 L	6
GNP12065	6,5 cm prof. - 4,1 L	6
GNP12100	10 cm prof. - 6,4 L	6
GNP12150	15 cm prof. - 9,4 L	6
GNP12200	20 cm prof. - 12,4 L	6

Bac perforé GN 1/2 - 32,5 x 26,5 cm

Code	Description	UE
GPP12065	6,5 cm - 4,1 L	6
GPP12100	10 cm - 6,4 L	6
GPP12150	15 cm - 9,4 L	6
GND12000	Fond perforé	6

Couvercle GN 1/2 - 32,5 x 26,5 cm

Code	Description	UE
GNL12000	Normal	6
GNLN12000	À encoche	6

Tous les articles en **gras** sont des produits de stock habituel. Consulter les couleurs disponibles.

■ Gamme GN en acier inoxydable pour le four (suite)



GN 1/3 - 17,6 x 32,5 cm

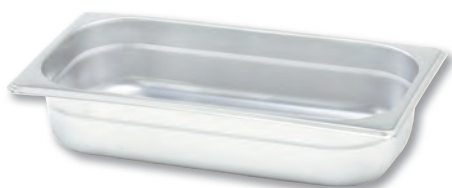

Bac GN 1/3 - 32,5 x 17,6 cm

Code	Description	UE
GNP13040	4 cm prof. - 1,9 L	6
GNP13065	6,5 cm prof. - 2,6 L	6
GNP13100	10 cm prof. - 3,3 L	6
GNP13150	15 cm prof. - 5,8 L	6
GNP13200	20 cm prof. - 7,6 L	6
GND13000	Fond perforé	6

Couvercle GN 1/3 - 32,5 x 17,6 cm

Code	Description	UE
GNL13000	Normal	6
GNLN13000	À encoche	6

GN 1/4 - 16,2 x 26,5 cm



Bac GN 1/4 - 16,2 x 26,5 cm

Code	Description	UE
GNP14065	6,5 cm prof. - 1,8 L	6
GNP14100	10 cm prof. - 2,8 L	6
GNP14150	15 cm prof. - 4,2 L	6
GNP14200	20 cm prof. - 5,6 L	6

Couvercle GN 1/4 - 16,2 x 26,5 cm

Code	Description	UE
GNL14000	Normal	6

GN 1/6 - 16,2 x 17,6 cm



Bac GN 1/6 - 16,2 x 17,6 cm

Code	Description	UE
GNP16065	6,5 cm prof. - 1,1 L	6
GNP16100	10 cm prof. - 1,8 L	6
GNP16150	15 cm prof. - 2,5 L	6
GNP16200	20 cm prof. - 3,2 L	6

Couvercle GN 1/6 - 16,2 x 17,6 cm

Code	Description	UE
GNL16000	Normal	6
GNLN16000	À encoche	6

Tous les prix sont indiqués en P.V.P. unitaire.

Gamme GN en acier inoxydable pour le four (suite)



GN 1/9 - 10,8 x 17,6 cm

Bac GN 1/9 - 10,8 x 17,6 cm

Code	Description	UE
GNP19065	6,5 cm prof. - 0,6 L	6
GNP19100	10 cm prof. - 0,9 L	6

Couvercle GN 1/9 - 10,8 x 17,6 cm

Code	Description	UE
GNL19000	Normal	6
GNLN19000	À encoche	6



Gamme GN en aluminium pour le four



Bac GN 1/1

Code	Description	UE
182C20	2 cm prof.	1
182C65	6,5 cm prof.	1
182C100	10 cm prof.	1

Plat avec revêtement intérieur et extérieur B-Cristal

Code	Description	UE
182SS20	GN 1/1 - 2 cm prof.	1
182SS40	GN 1/1 - 4 cm prof.	1
182SS60	GN 1/1 - 6 cm prof.	1
282SS20	GN 1/2 - 2 cm prof.	1
282SS40	GN 1/2 - 4 cm prof.	1
282SS60	GN 1/2 - 6 cm prof.	1

Plat microperforé

Code	Description	UE
182MF1/1	GN 1/1 - 2 cm prof.	1
182MFB	GN 1/1 - 2 cm prof. - avec rainures	1
182MFS1/1	GN 1/1 - 2 cm prof. - antiadhérent	1
182MFBS	GN 1/1 - 2 cm prof. - avec rainures - antiadhérent	1

Bac

Code	Description	UE
1821/1-20	GN 1/1 - 2 cm prof.	1
1821/1-40	GN 1/1 - 4 cm prof.	1
1821/1-65	GN 1/1 - 6,5 cm prof.	1
182F1/1	GN 1/1 - 2 cm prof. - perforé	1



Modèles compatibles et empilables avec les bacs GN de CAMBRO.
Peuvent s'utiliser avec les couvercles hermétiques CAMBRO 10CWGL.



Tous les articles en **gras** sont des produits de stock habituel. Consulter les couleurs disponibles.

■ Gamme GN en aluminium pour le four *(suite)*

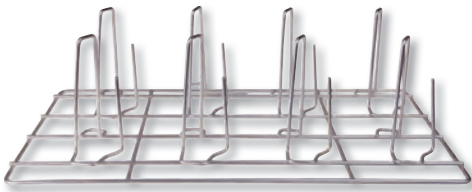

Panier pour rôti le poulet à la verticale

Code	Description	UE
182C1/1	GN 1/1	1



Plaque pour baguettes - microperforée

Code	Description	UE
49B53	GN 1/1 - 2 cm prof.	1
49B60	60 x 40 x 3,5 cm prof.	1



Bac avec revêtement antiadhérent

Code	Description	UE
182S1/1-20	GN 1/1 - 2 cm prof.	1
182S1/1-40	GN 1/1 - 4 cm prof.	1
182S1/1-65	GN 1/1 - 6,5 cm prof.	1



Plaque avec moules

Code	Description	UE
1831/1	GN 1/1 - 6 moules de 125 mm Ø	1
1832/1	GN 2/1 - 12 moules de 125 mm Ø	1
183S1/1	GN 1/1 - 6 moules de 125 mm Ø - noir	1
183S2/1	GN 2/1 - 12 moules de 125 mm Ø - noir	1

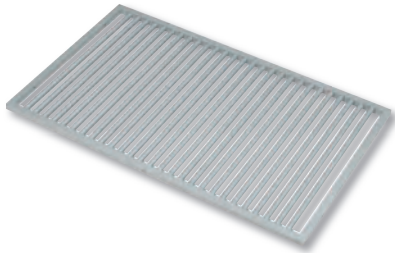

Grille pour grillades avec revêtement antiadhérent B-Cristal

Code	Description	UE
182G1/1	53 x 32,5 cm	1
182G2/1	65 x 53 cm	1
182G2/3	35,4 x 32,5 cm	1

■ Barres de séparation universelles

Barres en acier inoxydable, aspect miroir. Les barres offrent des options pour diviser la table de cuisine de sorte qu'elles intègrent tous les bacs de service alimentaire.

CWA12

Barre de séparation

33 cm



INOX.

CWA20

Barre de séparation

53,5 cm



INOX.



Tous les prix sont indiqués en P.V.P. unitaire.



Pour transporter vos plats et autres préparations de façon pratique et en toute sécurité, profitez des produits de transport isothermes de CAMBRO. Afin de choisir l'équipement isotherme le plus approprié pour vous, prenez en compte la capacité du conteneur, le temps de transport, le personnel, les véhicules avec lesquelles vous comptez et votre budget. Tous nos produits bénéficient d'excellentes performances isothermes, d'un grand format résistance et durabilité. Nous disposons d'un large choix d'accessoires qui garantissent davantage la conservation thermique. La conception des conteneurs CAMBRO a été réalisée en pensant à la facilité de transport et de nettoyage. Choisissez le modèle qui correspond le mieux à vos besoins.

Les conteneurs isothermes Cam GoBox, sont fabriqués en polypropylène expansé (EPP) et sont incroyablement légers. Disponibles en chargement par le haut et chargement frontal.

Chargement par le haut



Poignées ergonomiques
garantissent une manipulation facile et sûre

Robuste
avec une excellente absorption d'énergie, supporte les impact forts sans se détériorer



Ultraléger
fabriqué en polypropylène expansé, base en mousse isolante haute performance

100% recyclable
C'est le conteneur isotherme le plus écologique et sans CFC (chlorofluorocarbones)

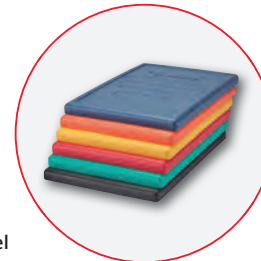

Couleurs
des couvercle colorés pour une identification rapide des contenus ou destinations

Kit insert optionnel
pour une conservation optimale, permet de transporter du froid en protégeant les aliments de la condensation



- Fabriqué en polypropylène expansé (EPP), un matériel constitué d'une mousse écologique aute performance.
- Maintient la température durant 4 heures de manière sûre.

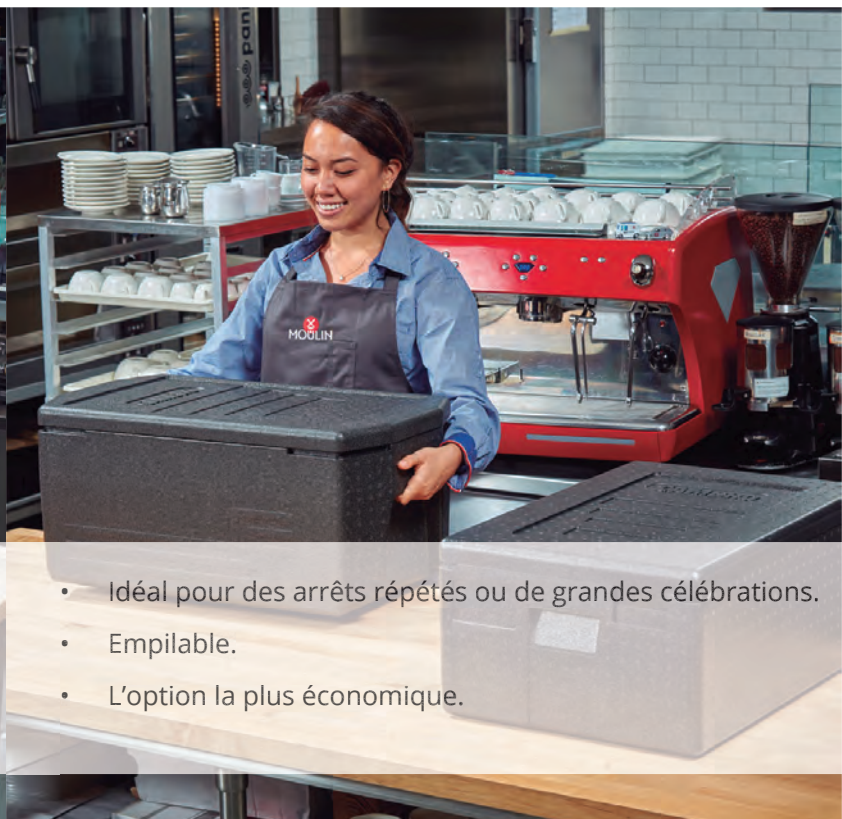

- Idéal pour des arrêts répétés ou de grandes célébrations.
- Empilable.
- L'option la plus économique.

Tous les prix sont indiqués en P.V.P. unitaire.

Cam GoBox à chargement par le haut

Solution parfaite pour les traiteurs, le service à domicile et tout exploitants de services alimentaires ayant besoin de flexibilité et de durabilité. Les matériaux de haute technologie et le design ergonomique réduisent son poids.



EPP280BKST

Cam GoBox à chargement par le haut et anse noire

39 x 33 x 31,6 cm (ext.)
33 x 27 x 25,3 cm (int.)
22,3 L



● 110



EPP280RDST

Cam GoBox à chargement par le haut et anse rouge

39 x 33 x 31,6 cm (ext.)
33 x 27 x 25,3 cm (int.)
22,3 L



● 110



EPPBEVBKST

Cam GoBox à chargement par le haut et anse noire

42 x 33,5 x 42 cm (ext.)
35,8 x 27,3 x 36,7 cm (int.)
35 L



● 110



EPPBEVRDST

Cam GoBox à chargement par le haut et anse rouge

42 x 33,5 x 42 cm (ext.)
35,8 x 27,3 x 36,7 cm (int.)
35 L



● 110



EPP160

Cam Gobox GN 1/1

60 x 40 x 25,7 cm (ext.)
53,8 x 33,8 x 19,3 cm (int.)
35,5 L



● 110



EPP180

Cam Gobox GN 1/1

60 x 40 x 31,6 cm (ext.)
53,8 x 33,8 x 25,3 cm (int.)
46 L



● 110



EPP180S

Cam Gobox GN 1/1

60 x 40 x 18,2 cm (ext.)
53,8 x 33,8 x 15,9 cm (int. superior)
50,4 x 30,2 x 9,5 cm (int. inferior)
43 L



● 110



EPP180LH

Cam Gobox GN 1/1

68 x 40 x 32,1 cm (ext.)
53,8 x 35,5 x 25,5 cm (int.)
46 L



● 110



EPP260

Cam Gobox GN 1/2

39 x 33 x 25,7 cm (ext.)
33 x 27 x 19,3 cm (int.)
16,9 L



● 110



EPP280

Cam Gobox GN 1/2

39 x 33 x 31,6 cm (ext.)
33 x 27 x 25,3 cm (int.)
22,3 L



● 110



EPP4060T200

Cam Gobox pour plaques de 60x40 cm sur 20 cm

49 x 69 x 27 cm (ext.)
42,5 x 62,5 x 20,5 cm (int.)
53 L



● 110



EPP4060T300

Cam Gobox pour plaques de 60x40 cm sur 30 cm

49 x 69 x 37 cm (ext.)
42,5 x 62,5 x 30,5 cm (int.)
80 L



● 110



EPP3253LID-110

Couverture pour EPP180, EPP180S et EPP160

60 x 40 x 3,4 cm



● 110

Tous les articles en **gras** sont des produits de stock habituel. Consulter les couleurs disponibles.

Cam GoBox à chargement frontal

Chargement frontal

Manipulation facile

les poignées intégrées sur le dessus permettent une manutention facile

Acceso completo

la porte s'ouvre à 270° et peut rester ouverte pour faciliter l'accès aux produits



Ouverture et fermeture faciles
les bords biseautés garantissent une ouverture, une fermeture et un verrouillage sans effort

Facilite l'égouttement

Dispositif d'évacuation de la condensation pour faciliter l'égouttement

EPP300

Cam Gobox pour 3 bacs GN 1/1

64 x 44 x 47,5 cm (ext.)

53,5 x 33 x 37 cm (int.) - 60 L



● 110



EPP400

Cam Gobox pour 4 bacs GN 1/1

64,5 x 44 x 63 cm (ext.)

53,5 x 33 x 52,5 cm (int.) - 86 L



● 110



EPP300



EPP400

EPP4060F6R

Cam Gobox pour bacs de 60 x 40 cm avec 6 glissières

77 x 54 x 68,7 cm (ext.)

61,5 x 41 x 58,5 cm (int.) - 126 L



● 110



EPP4060F9R

Cam Gobox pour bacs de 60 x 40 cm avec 9 glissières

77 x 54 x 68,7 cm (ext.)

61,5 x 41 x 58,5 cm (int.) - 126 L



● 110



EPP4060FNR

Cam Gobox pour bacs de 60 x 40 cm sans glissière

77 x 54 x 68,7 cm (ext.)

61,5 x 41 x 58,5 cm (int.) - 155 L



● 110

EPP4060FADJR

Cam Gobox pour bacs de 60 x 40 cm avec 2 jeux de glissières ajustables

61,5 x 54 x 68,7 cm (ext.)

61,5 x 41 x 58,5 cm (int.) - 155 L



● 110



EPP4060FPR1

Kit de glissières ajustables pour EPP4060FNR. Métalliques.

60 x 1 x 58 cm



Tous les prix sont indiqués en P.V.P. unitaire.



Cam GoBox - Accessoires



CP3253

Plaque froide
Camchiller
GN 1/1 pour EPP160,
EPP180, EPP180LH,
EPP300 et EPP400

53 x 32,5 x 3 cm



● 443



CP2632

Plaque froide
Camchiller
GN 1/2 pour EPP260,
EPP280, EPP280BKST
et EPP280RDST

32,5 x 26,5 x 3 cm



● 443



HP3253

Plaque chaude
Camwarmer GN 1/1
pour EPP160, EPP180,
EPP180LH, EPP300
et EPP400

53 x 32,5 x 3 cm



● 444



HP2632

Plaque chaude
Camwarmer GN 1/2
pour EPP160, EPP180,
EPP180LH, EPP300
et EPP400

32,5 x 26,5 x 3 cm



● 444



EPP3253DIV

Séparateur
Thermobarrier
pour EPP300 et EPP400

53 x 32,7 x 3,7 cm



● 110



EPPCTL

Insert avec poignées
pour EPP180LH

68 x 40 x 8,7 cm (ext.)
- 53,7 x 33,7 x 3,4 cm
(int.)



● 110



EPPCTS

Insert sans poignée
pour EPP180, EPP180S
et EPP160

68 x 40 x 8,7 cm (ext.)
- 53,7 x 33,7 x 3,4 cm
(int.)



● 110



CD3253EPP

Socle rouleur Camdolly
pour tous les modèles
GN

53 x 32,5 x 3,7 cm



● 158



CD4060EPP

Socle rouleur Camdolly
pour EPP4060 à
chargement supérieur
et frontal

71 x 51 x 16 cm



● 158



EPPIDS

Jeu de 5 étiquettes
d'identification
en plastique

5 x 9 cm



● Couleurs variés

CDC300

Socle rouleur Camdolly pour
UPC300, EPP400, EPP300, EPP180,
EPP160, EPP140 et EPP180LH

63,4 x 44,1 x 18,5 cm (ext.)
62,5 x 43,4 cm (int.)



● 358



CDC400

Socle rouleur Camdolly
pour UPC400 et EPP180XLT

64,3 x 47 x 18,5 cm (ext.)
63,1 x 46,9 cm (int.)



● 358



Tous les articles en **gras** sont des produits de stock habituel. Consulter les couleurs disponibles.



Cam GoBox - Conteneur à chargement par le haut



EPP140

Cam Gobox à chargement par le haut

60 x 40 x 20,7 cm (ext.)
53,8 x 33,8 x 14,5 cm (int.)
26 L



● 110



EPPEXT

Insert pour EPP140, EPP160, EPP160CL,
EPP180, EPP180S, EPP180LH
et EPP180CL

60 x 40 x 10 cm (ext.)



● 110



EPPFLID

Couvercle battant pour EPP140, EPP160,
EPP160CL, EPP180, EPP180S, EPP180LH
et EPP180CL

60 x 40 x 4 cm



● 110



EPP160CL

Cam Gobox à chargement par le haut
et couvercle coloré

60 x 40 x 25,7 cm (ext.)
53,8 x 33,8 x 19,3 cm (int.)
46 L



Conteneur : ● 110

Couvercles : ● 365 ● 363 ● 361 ● 360
● 362



EPP180CL

Cam Gobox à chargement par le haut
et couvercle coloré

60 x 40 x 31,6 cm (ext.)
53,8 x 33,8 x 25,4 cm (int.)
46 L



Conteneur : ● 110

Couvercles : ● 365 ● 363 ● 361 ● 360
● 362



EPP3253LID

Couvercles colorés pour EPP140,
EPP160, EPP160CL, EPP180, EPP180S,
EPP180LH et EPP180CL

60 x 40 x 3,3 cm



● 365 ● 363 ● 361 ● 360 ● 362

Tous les prix sont indiqués en P.V.P. unitaire.

Cam GoBox - Conteneur à chargement par le haut (suite)



Conteneurs conçus, principalement, pour plats pré-emballés, des bacs à glaces ou des emballages jetables.



EPP180X

Cam GoBox Multifonction

61 x 43 x 27 cm (ext.)
54,8 x 36,8 x 20 cm (int.)
41 L



● 110



EPP180XL

Cam GoBox Multifonction

61 x 43 x 32 cm (ext.)
54,8 x 36,8 x 25 cm (int.)
50,5 L



● 110



EPP180XLT

Cam GoBox Multifonction

61 x 43 x 39 cm (ext.)
54,8 x 36,8 x 32 cm (int.)
64,5 L



● 110



EPPMBWSTSW

Conteneur pour bricks de lait

41 x 41 x 40,4 cm (ext.)
35 x 35 x 34,3 cm (int.)



● 110

Plaque chauffante Cam GoHeat



Chauffe jusqu'à 75°C en seulement 10 minutes après le branchement. Placez-la dans le fond de votre conteneur isotherme ou utilisez-la pour présenter des aliments chauds sur une table, un comptoir ou un buffet.

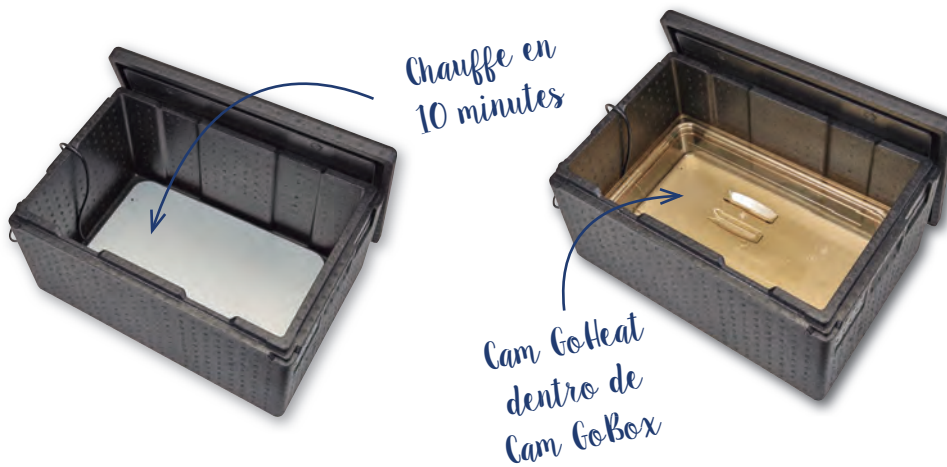

CGH100WEU

Cam GoHeat 100W, 220/240 V.
avec prise électrique

49,5 x 28,5 x 1,2 cm



● 486



CGH200WEU

Cam GoHeat 200W, 220/240 V.
avec prise électrique

49,5 x 28,5 x 1,2 cm



● 486



CGH1W12VCAR

Cam GoHeat pour voiture 100W, 12/14,2 V.

49,5 x 28,5 x 1,2 cm



● 486

Tous les articles en **gras** sont des produits de stock habituel. Consulter les couleurs disponibles.

■ Cam GoBox - Guide de capacités

EPP160 - GN 1/1 et EPP260 - GN 1/2



EPP180 - GN 1/1 et EPP280 - GN 1/2

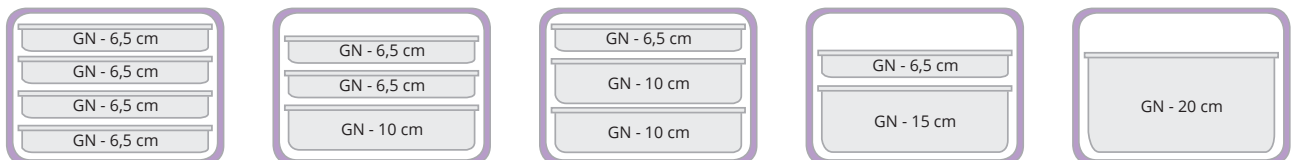

EPP180S - GN 1/1

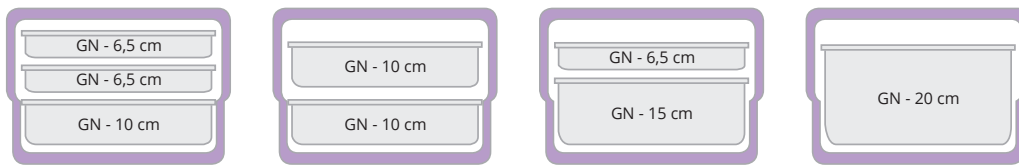

EPP300 - GN 1/1

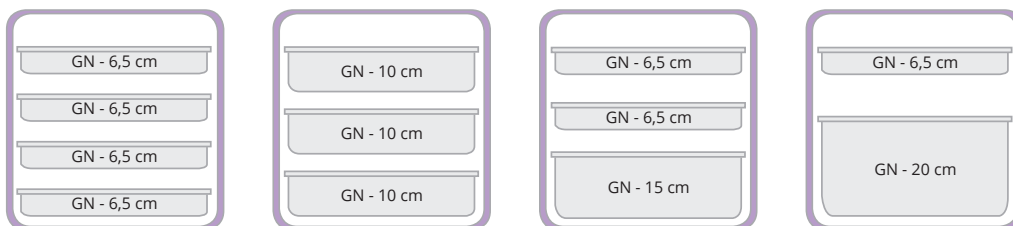

EPP400 - GN 1/1

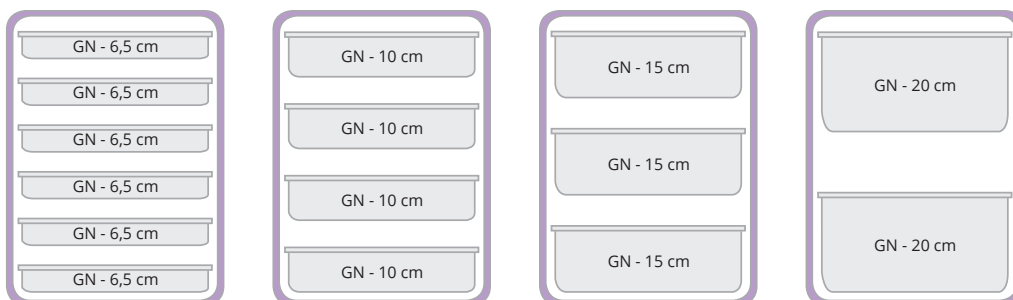

Tous les prix sont indiqués en P.V.P. unitaire.

Boîte à repas à 2 compartiments

Cette boîte à deux compartiments est idéale pour un seul repas. Les deux compartiments ont leur propre couvercle ce qui permet une séparation totale pour maintenir les températures froides ou chaudes. Idéal en collectivité, Maison de retraite, écoles, hopitaux y pour les traiteurs.

EPPMDB4428

Boîte à repas à 2 compartiments

43,7 x 27,6 x 17,5 cm (ext.)

22,6 x 18,3 x 10,9 cm (int.)

1

159



A. Récipient : 22,6 x 18,3 x 10,9 cm
B. Récipient : 22,6 x 18,3 x 10,9 cm



Boîte à repas à 4 compartiments



EPPMD4835

Boîte à repas à 3 compartiments

42 x 29 x 11 cm (int)

48 x 35 x 16,7 cm (ext)

1

159

Compartiment pour aliment froids
Pour des plats de 21 X 21 x 11 cm

Compartiment pour aliments chauds
pour des plats de 19 X 19 x 11 cm

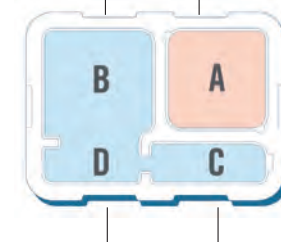

Pour un fruit ou du pain
18 x 8 x 11 cm

Pour une bouteille
et des couverts
21 x 8,5 x 11 cm

Rejoignez-nous



@DbmarkTweet



@dbmarkhosteleria



@dbmark_inst

Tous les articles en **gras** sont des produits de stock habituel. Consulter les couleurs disponibles.



Gobag sacs à dos de livraison



Les livreurs peuvent se déplacer et marcher les mains libres en choisissant l'un de nos deux sacs à dos pour que la nourriture arrive à la bonne température et de manière sûre.

- Extérieur imperméable.
- Intérieur lavable.
- Isolation haute densité qui maintient la température et la qualité des aliments.
- Séparateur thermique les plats chauds des plats froids.
- Pliable pour un rangement plus compact.
- Nettoyage facile.



GBBP111417

Sac à dos petit format
28 x 35,5 x 43,2 cm



● 110



GBBP151417

Sac à dos grand format
38,1 x 35,5 x 43,2 cm



● 110

*Pliable pour
un rangement
compact*



Tous les prix sont indiqués en P.V.P. unitaire.



Porte-verres pour boissons



Maintient les boissons en toute sécurité pendant le transport et conserve leur température pendant plus de 3. Les compartiments sont conçus pour s'adapter à différents formats. Ces porte-boissons s'adaptent à plusieurs tailles de Cam Gobox.



EPPBEVH5*
Porte-boissons
Jeu de 5 supports pour 15 boissons
 1
● 110
* No incluye vasos



EPPBEVH2*
Porte-boissons
Jeu de 2 supports pour 6 boissons
 1
● 110



EPPBEVH1*
Porte-boissons
Un support pour 3 boissons
 1
● 110

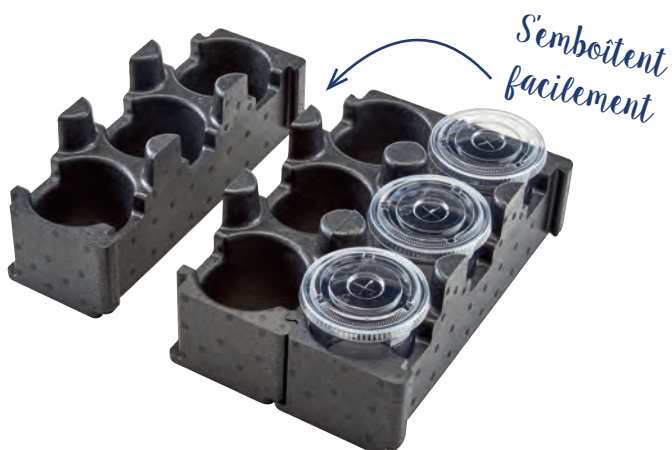

Tous les articles en **gras** sont des produits de stock habituel. Consulter les couleurs disponibles.

Cam GoBox pour pizza à chargement par le haut



La Cam GoBox for Pizza protège la pizza des intempéries, en la gardant fraîche, délicieuse et croustillante. Disponible en quatre hauteurs pouvant contenir de deux à huit boîtes à pizza de 33 x 33 cm.



EPPZ35100

Cam GoBox pour pizzas à chargement supérieur sans anse

41 x 41 x 17,4 cm (ext.)
35 x 35 x 10 cm (int.)
2 pizzas



● 110

EPPZ35175

Cam GoBox pour pizzas à chargement supérieur sans anse

41 x 41 x 24,9 cm (ext.)
35 x 35 x 17,5 cm (int.)
4 pizzas



● 110

EPPZ35175BST

Cam GoBox pour pizzas à chargement supérieur et anse noire

41 x 41 x 24,9 cm (ext.)
35 x 35 x 17,5 cm (int.)
4 pizzas



● 110

EPPZ35175RST

Cam GoBox pour pizzas à chargement supérieur et anse rouge

41 x 41 x 24,9 cm (ext.)
35 x 35 x 17,5 cm (int.)
4 pizzas



● 110

EPPZ35265

Cam GoBox pour pizzas à chargement supérieur sans anse

41 x 41 x 33,9 cm (ext.)
35 x 35 x 26,5 cm (int.)
6 pizzas



● 110

EPPZ35265BST

Cam GoBox pour pizzas à chargement supérieur et anse noire

41 x 41 x 33,9 cm (ext.)
35 x 35 x 26,5 cm (int.)
6 pizzas



● 110

EPPZ35265RST

Cam GoBox pour pizzas à chargement supérieur et anse rouge

41 x 41 x 33,9 cm (ext.)
35 x 35 x 26,5 cm (int.)
6 pizzas



● 110

EPPZ35330

Cam GoBox pour pizzas à chargement supérieur sans anse

41 x 41 x 40,4 cm (ext.)
35 x 35 x 33 cm (int.)
8 pizzas



● 110

EPPZ35330BST

Cam GoBox pour pizzas à chargement supérieur et anse noire

41 x 41 x 40,4 cm (ext.)
35 x 35 x 33 cm (int.)
8 pizzas



● 110

EPPZ35330RST

Cam GoBox pour pizzas à chargement supérieur et anse rouge

41 x 41 x 40,4 cm (ext.)
35 x 35 x 33 cm (int.)
8 pizzas



● 110

Cam GoBags - Sacs à pizza et catering

Sacs isothermes idéals pour la livraison des aliments chauds et froids, en particuliers les pizzas. Matériau respirant qui préserve la qualité des aliments.



GBP216

Sac à pizza standard

42 x 46 x 16,5 cm
Deux boîtes à pizza de 40,6 cm ou trois boîtes de 35,5 cm



● 110 ● 521



GBP318

Sac à pizza standard

44,5 x 51 x 19 cm
Trois boîtes à pizza de 45,7 cm ou quatre boîtes de 40,6 cm



● 110 ● 521



GBP518

Sac à pizza standard

49,5 x 49,5 x 32 cm
Cinq boîtes à pizza de 45,7 cm ou six boîtes de 40,6 cm



● 110



GBP220

Sac à pizza standard

43 x 55 x 16,5 cm -
Deux boîtes à pizza de 51 cm ou trois boîtes de 45,7 cm



● 110 ● 521

Tous les prix sont indiqués en P.V.P. unitaire.



Cam GoBags - Sacs de transport



GBD101011

Sac de transport pliable petit format

25,5 x 25,5 x 28 cm



● 110



GBD121515

Sac de transport pliable format moyen

30,5 x 38 x 38 cm



● 110



GBD211417

Sac de transport grand format pour récipients GN 1/1

53,5 x 35,5 x 43 cm



● 110



GBD13913

Sac de transport petit format

33 x 23 x 33 cm



● 110



GBD151212

Sac de transport format moyen

38 x 30,5 x 30,5 cm



● 110



GBD211414

Sac de transport grand format

53,5 x 35,5 x 35,5 cm - Récipients GN 1/1



● 110

Rejoignez-nous



@DbmarkTweet



@dbmarkhosteleria



@dbmark_inst

Tous les articles en **gras** sont des produits de stock habituel. Consulter les couleurs disponibles.



Eco-Takeouts



L'alternative écologique aux conteneurs jetables. Les Eco-Takeouts sont réutilisables, écologiques et recyclables (#5).



*Contactez-nous
pour vos
personnalisations
et couleurs disponibles*



EC-08-1-

Boîte individuelle
et couvercle

12,1 x 12,1 x 8,3 cm

24

○ CL ● JA



EC-09-1-

Boîte à 3 compartiments
et couvercle

23 x 23 x 8,9 cm

12

○ CL ● JA ● BK



EC-10-1-

Boîte individuelle
et couvercle

23 x 23 x 8,9 cm

12

○ CL ● JA ● BK



EC-11-1-

Boîte taille moyenne
et couvercle

22,9 x 16,5 x 7 cm

12

○ CL ● JA ● BK



EC-12-1-

Boîte à 3 compartiments
et couvercle

22,9 x 22,9 x 6,3 cm

12

○ CL ● JA



EC-15-2

Boîte à 2 compartiments
et couvercle

25,4 x 20,3 x 7,6 cm

12

○ CL ● JA



EC-16-

Boîte à 3 compartiments
et couvercle plat

22,9 x 22,9 x 5,1 cm

12

● JA

Tous les prix sont indiqués en P.V.P. unitaire.

■ Eco-Takeouts (suite)



EC-17-JA

Boîte taille moyenne et couvercle plat

22,9 x 22,9 x 5,1 cm

🍽️ 12

● JA



EC-18-JA

Boîte taille moyenne avec couvercle plat

22,9 x 16,5 x 5,1 cm

🍽️ 12

● JA



EC-19-

Boîte taille moyenne avec couvercle

20,3 x 14 x 7 cm

🍽️ 12

○ CL ● JA



EC-25-1-

Boîte pour tranche de pizza

26,7 x 21 x 2 cm

🍽️ 24

○ CL ● JA



EC-20-

Pot avec couvercle à charnière
200 ml

8,3 cm x 7,6 cm

🍽️ 24

○ CL ● JA



EC-21-

Pot avec couvercle à charnière
414 ml

10,6 cm x 9,9 cm

🍽️ 24

○ CL ● JA



EC-23-

Récipient à soupe
355 ml

11 cm Ø x 6 cm

🍽️ 12

○ CL ● JA ● BK



EC-24-

Récipient à soupe
473 ml

11 cm Ø x 7,3 cm

🍽️ 12

○ CL ● JA



EC-07-1-

Récipient à soupe et couvercle
355 ml, 10,8 cm Ø

🍽️ 12

○ CL ● JA











EC-13-1-

Récipient à soupe et couvercle
473 ml, 10,8 cm Ø

🍽️ 12

○ CL ● JA

- ✓ 100% sans BPA 
- ✓ Ecologiques 
- ✓ Réutilisables et recyclables (#5) 
- ✓ Certifiés para la NSF 
- ✓ Plus de 1.000 utilisations
- ✓ 11 formes différentes
- ✓ Aptes au lave-vaisselles 
- ✓ Apte au micro-ondes 
- ✓ Empilables 
- ✓ Personnalisables 

Tous les articles en **gras** sont des produits de stock habituel. Consulter les couleurs disponibles.

Camserver

- Conteneur pour servir des boissons chaudes ou froides.
- Coque en polyéthylène à double paroi et mousse épaisse isolante.
- Larges fermetures.
- Deux plaques signalétiques à double-face.
- Ouverture supérieure pour le réapprovisionnement sans besoin d'enlever le couvercle.



Consulter les pièces de rechange pour ces articles dans le chapitre PIÈCES DE RECHANGES



Conservation de la chaleur

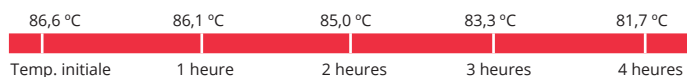

CSR3

Conteneur isotherme pour boissons. Camserver

46,5 x 34 x 60 cm - 11,5 L



● 110 ● 191 ● 417



CSR5

Conteneur isotherme pour boissons. Camserver

46,5 x 34 x 71 cm - 19 L



● 110 ● 191 ● 417



Conteneurs isothermes pour boissons

- Idéal pour ranger, transporter et servir des boissons chaudes ou froides.
- Conçu en polyéthylène d'un seul corps à double paroi sans joint, avec une épaisse mousse isolante.
- Les verrous solides assurent une excellente fermeture et sont à l'épreuve de la rouille.
- Robinet anti-goutte encastré permettant une distribution continue et individuelle
- Des éleveurs peuvent être utilisés pour remplir de grandes tasses ou des carafes de café.
- Le système Sta-stack assure un empilement stable durant le transport et l'entreposage.



Capuchon d'aération : Équilibre la pression et permet à la vapeur de s'échapper pour faciliter l'ouverture du conteneur.

Poignées moulées: transport confortable et sûr.

Robinet en retrait : encastré pour ajuster tasses et bols. Assure une distribution uniforme, et élimine le goutte à goutte. Deux positions : écoulement continu et tasse par tasse.

Plaque métallique de renforcement moulé. Empêche les systèmes de fermeture d'être arrachés du conteneur.



Conservation de la chaleur

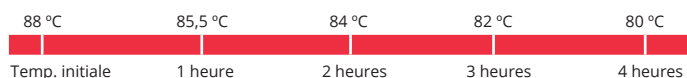

Conservation du froid

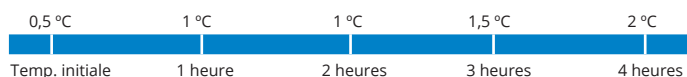

Tous les prix sont indiqués en P.V.P. unitaire.

■ Conteneurs isothermes pour boissons (suite)



100LCD

Conteneur isotherme pour boissons. -
Camtainer

29 x 26,5 x 44 cm - 5 L



Couleurs disponibles : ● 131 ● 157

Couleurs sur commande : ● 110 ● 186

● 192 ● 402 ● 519



250LCD

Conteneur isotherme pour boissons. -
Camtainer

42 x 23 x 47 cm - 9,4 L



Couleurs disponibles : ● 131 ● 157

Couleurs sur commande : ● 110 ● 186

● 192 ● 402 ● 519



500LCD

Conteneur isotherme pour boissons. -
Camtainer

42 x 23 x 62 cm - 18 L



Couleurs disponibles : ● 131 ● 157

Couleurs sur commande : ● 110 ● 186

● 192 ● 402 ● 519



1000LCD

Conteneur isotherme pour boissons. -
Camtainer

53 x 41,5 x 63 cm - 44,4 L



Couleurs disponibles : ● 131 ● 157

Couleurs sur commande : ● 110 ● 186

● 192 ● 402 ● 519



350LCD

Conteneur isotherme pour boissons. -
Camtainer

42 x 23 x 47 cm - 12,7 L



Couleurs disponibles : ● 131 ● 157

Couleurs sur commande : ● 110 ● 186

● 192 ● 402 ● 519



Tous les articles en **gras** sont des produits de stock habituel. Consulter les couleurs disponibles.

Conteneurs isothermes pour boissons (suite)



UC250

Conteneur isotherme pour boissons.
Ultra Camtainer

42,5 x 30 x 50 cm - 10,4 L



● 110 ● 131 ● 157 ● 186 ● 191
● 192 ● 194 ● 401 ● 402 ● 519



UC500

Conteneur isotherme pour boissons.
Ultra Camtainer

42,5 x 30 x 68 cm - 19,9 L



● 110 ● 131 ● 157 ● 186 ● 191
● 192 ● 194 ● 401 ● 402 ● 519



UC1000

Conteneur isotherme pour boissons.
Ultra Camtainer

52 x 41,5 x 65,5 cm - 39,7 L



● 110 ● 131 ● 157 ● 186 ● 191
● 192 ● 194 ● 401 ● 402 ● 519



- Les accessoires de lave-mains s'adaptent aux Camtainers 250LCD et 500LCD ou Ultra Camtainers UC250 et UC500.
- Les accessoires de lave-mains incluent des étiquettes "pour lavage des mains seulement" et un distributeur Easy Serve.



R500LCD

Socle pour conteneur
isotherme 250LCD,
500LCD, UC250, UC500

41,5 x 23 x 12 cm



● 110 ● 131 ● 157
● 191 ● 401



R1000LCD

Socle pour conteneur
isotherme 1000LCD,
UC1000

49,5 x 39 x 11,5 cm



● 110 ● 131 ● 157
● 191 ● 401



LCDCH

Casier à condiments
pour conteneur
isotherme 250LCD,
500LCD, UC250, UC500

42 x 22 x 13 cm



● 110 ● 131 ● 157
● 191 ● 401



LCDCH10

Casier à condiments
pour conteneur
isotherme 1000LCD,
UC1000

51 x 41 x 12 cm



● 110 ● 131 ● 157
● 191 ● 401

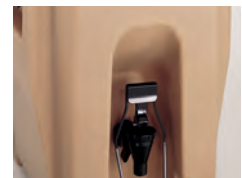

LCDES

Distributeur Easy
Server pour robinets
LCD et UC



● 110

HWAPR

Station de lavage avec distributeur
de papier en rouleau pour 250LCD,
500LCD, UC250, UC500

57 x 25,7 x 38,7 cm



● 110 ● 131



HWATD

Station de lavage avec distributeur
de papier plié pour 250LCD, 500LCD,
UC250, UC500

49,2 x 25,7 x 34 cm



● 110 ● 131



Tous les prix sont indiqués en P.V.P. unitaire.

Conteneurs isothermes à chargement par le haut

- Fabriqués en polyéthylène résistant et durable sans soudure avec une épaisse couche isolante en mousse.
- Avec des poignées moulées des quatre côtés pour une manutention plus facile.
- Idéales pour utiliser des barres de séparation pour ranger plusieurs bacs de tailles différentes.
- Les bacs sont faciles à retirer en plaçant les doigts sur les encoches.
- Les unités empilées se verrouillent les unes aux autres pour le transport et le stockage.



Consulter les pièces de rechange pour ces articles dans le chapitre PIÈCES DE RECHANGES

Conservation de la chaleur

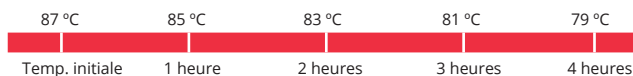

Conservation du froid

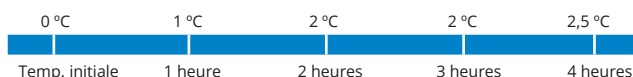

REMARQUE : Si vous utilisez des bacs métalliques pour les aliments, réduisez la température à 120 °C avant de les placer sur les glissières.

Guide de capacités

Gamme S			
UPCS140	UPCS160	UPCS180	UPCSS160
1 GN1/1 - 10 cm prof.	1 GN1/1 - 15 cm prof.	1 GN1/1 - 20 cm prof.	1 GN1/1 - 15 cm prof.
Ultra Pan			
UPC140	UPC160	UPC180	
1 GN1/1 - 10 cm prof.	1 GN1/1 - 15 cm prof.	1 GN1/1 - 20 cm prof.	
Gamme 100			
UPC100	UPC101	100MPC	100MPCHL
3 GN1/1 - 6,5 cm prof.	3 GN1/1 - 6,5 cm prof.	3 GN1/1 - 6,5 cm prof.	3 GN1/1 - 6,5 cm prof.
2 GN1/1 - 10 cm prof.	2 GN1/1 - 10 cm prof.	2 GN1/1 - 10 cm prof.	2 GN1/1 - 10 cm prof.
1 GN1/1 - 10/20 cm prof.	1 GN1/1 - 10/20 cm prof.	1 GN1/1 - 10/20 cm prof.	1 GN1/1 - 10/20 cm prof.
Camcarrier			
240MPC			
1 GN1/2 - 20 cm prof.			

Gamme S

Fabrication en polypropylène durable avec joint intégré et gros système de fermeture en nylon. Un look moderne et une excellente conservation de la chaleur à un prix modique.



UPCS140

Conteneur isotherme à chargement par le haut Gamme S

43,5 x 64 x 22 cm - 1 bac, GN 1/1 de 10 cm de profondeur



● 110 ● 131 ● 157 ● 480



UPCS160

Conteneur isotherme à chargement par le haut Gamme S

43,5 x 64 x 26 cm - 1 bac, GN 1/1 de 15 cm de profondeur



● 110 ● 480



UPCS180

Conteneur isotherme à chargement par le haut Gamme S

43,5 x 64 x 30,5 cm - 1 bac, GN 1/1 de 20 cm de profondeur



● 110 ● 131 ● 157 ● 480

Tous les articles en **gras** sont des produits de stock habituel. Consulter les couleurs disponibles.

Conteneurs isothermes à chargement par le haut (suite)

Ultra Pan

Construction monobloc en polyéthylène sans soudures, joint hermétique amovible et système solide de fermeture en nylon



UPC140

Conteneur isotherme à chargement par le haut Ultra Pan

44 x 63 x 21 cm - 1 bac, GN 1/1 de 10 cm de profondeur



● 110 ● 131 ● 157 ● 480



UPC160

Conteneur isotherme à chargement par le haut Ultra Pan

44 x 63 x 26 cm - 1 bac, GN 1/1 de 15 cm de profondeur



● 110 ● 131 ● 157 ● 480



UPC180

Conteneur isotherme à chargement par le haut Ultra Pan

44 x 63 x 30,5 cm - 1 bac, GN 1/1 de 20 cm de profondeur



● 110 ● 131 ● 157 ● 480

Gamme 100

Ranger et empiler les bacs GN ou placer directement les aliments dans le compartiment. Le modèle 100MP-CHL possède une ouverture à couvercle pour servir.



UPC100

Conteneur isotherme à chargement par le haut Gamme 100

46 x 68 x 40 cm - 1 bac, GN 1/1 de 10/20 cm, prof. ou 2 GN 1/1 de 10 cm, prof. ou 3 GN 1/1 de 6,5 cm, prof.



Couleurs sur commande : ● 110 ● 131 ● 157 ● 191 ● 192 ● 194 ● 401



100MPC

Conteneur isotherme à chargement par le haut Gamme 100

45 x 68 x 38 cm - 1 bac, GN 1/1 de 10/20 cm, prof. ou 2 GN 1/1 de 10 cm, prof. ou 3 GN 1/1 de 6,5 cm, prof.



Couleurs disponibles : ● 131
Couleurs sur commande : ● 110 ● 157 ● 158 ● 186 ● 401 ● 402 ● 519



100MPCHL

Conteneur isotherme à chargement par le haut Gamme 100

45 x 68 x 39,5 cm - 1 bac, GN 1/1 de 20 cm, prof.



Couleurs sur commande : ● 110 ● 131 ● 157 ● 158 ● 186 ● 401 ● 402 ● 519

Rejoignez-nous



@DbmarkTweet



@dbmarkhosteleria



@dbmark_inst

Tous les prix sont indiqués en P.V.P. unitaire.

■ Conteneurs isothermes à chargement frontal - UPC400

Consulter les pièces de rechange pour ces articles dans le chapitre PIÈCES DE RECHANGES



UPC400

Conteneur isotherme à chargement frontal

42,5 x 62 x 57 cm - 2 bacs, GN 1/1 de 20 cm, prof.
ou 3 GN 1/1 de 15 cm, prof. ou 4 GN 1/1 de 10 cm, prof.
ou 6 GN 1/1 de 6,5 cm, prof.



Couleurs disponibles : ● 131 ● 157 ● 401

Couleurs sur commande : ● 110 ● 159 ● 191 ● 192 ● 194

Valve pop-up
Pour le contrôle
de la pression et de l'humidité



Durabilité

fabriqué en polyéthylène
sans soudure avec épaisse
couche isolante de mousse

Design

incassable, ergonomique,
avec des poignées
pour un transport facile

Transportable
Sur notre Camdolly CD400



Guide de capacité



12 GN1/1 - 2 cm

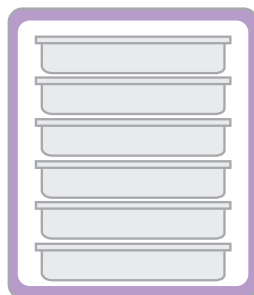

6 GN1/1 - 6,5 cm

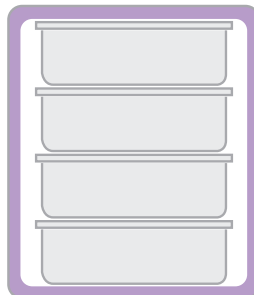

4 GN1/1 - 10 cm

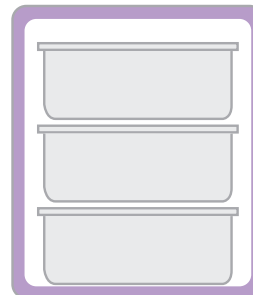

3 GN1/1 - 15 cm

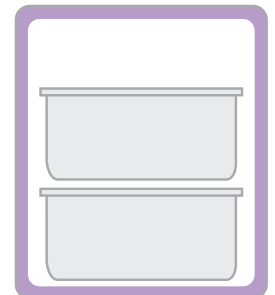

2 GN1/1 - 20 cm

Admet aussi
GN/2 et GN/3

Tous les articles en **gras** sont des produits de stock habituel. Consulter les couleurs disponibles.

Conteneurs isothermes à chargement frontal - UPC300

- La nouvelle génération des conteneurs 300 est arrivée.
- Pour bacs GN 1/1, GN 1/2 et GN 1/3.
- Épaisse couche isolante en polyuréthane qui permet de conserver en toute sécurité les aliments froids en dessous de 4° et les aliments chauds au-dessus de 64° pendant plus de 4 heures.



Consulter
les pièces de
rechange pour
ces articles
dans le chapitre
**PIÈCES DE
RECHANGES**

UPC300

Conteneur isotherme à chargement frontal

43,2 x 65,4 x 56,8 cm - 1 bac, GN 1/1 de 20 cm prof.
ou 2 GN 1/1 de 15 cm prof. ou 3 GN 1/1 de 10 cm prof.
ou 4 GN 1/1 de 6,5 cm prof.



Couleurs disponibles : ● 131 ● 401

Couleurs sur commande : ● 110 ● 158 ● 186 ● 615

1318CC

Conteneur isotherme à chargement frontal

43,2 x 65,4 x 56,8 cm



Couleurs disponibles : ● 131 ● 401

Couleurs sur commande : ● 110 ● 158 ● 186 ● 615

Durable
Fabrication sans soudure

Transportable
Sur notre Camdolly CD300



Compacte
Sa taille permet un transport
aisé dans tout type de véhicule

Empilable
Pour un transport
et un stockage plus facile

Identification
Possibilité d'étiquetage
sur la porte



Guide de capacité

UPC300		
GN 1/1	GN 1/2	GN 1/3
4 GN1/1 - 6,5 cm	8 GN 1/2 - 6,5 cm	12 GN1/3 - 6,5 cm
3 GN1/1 - 10 cm	6 GN 1/2 - 10 cm	9 GN1/3 - 10 cm
2 GN1/1 - 15 cm	4 GN 1/2 - 15 cm	6 GN1/3 - 15 cm
1 GN1/1 - 20 cm	2 GN 1/2 - 20 cm + 2 GN 1/2 - 10 cm	3 GN1/3 - 20 cm + 3 GN 1/3 - 10 cm

Tous les prix sont indiqués en P.V.P. unitaire.



Accessoires

Pour le froid - Camchiller



- Accessoire facile à utiliser pour la conservation de température des aliments froids.
- Prolonge la durée de conservation à froid ou assure que la température reste à un niveau salubre inférieur à 5° quand un accès différent est nécessaire.

Conservation du froid

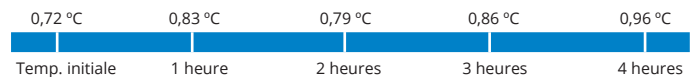

CP3253

Plaque froide Camchiller GN 1/1 pour EPP160, EPP180, EPP180LH, EPP300 et EPP400

53 x 32,5 x 3 cm



● 443



CP1210

Plaque froide GN 1/2 pour chariot isotherme

32,4 x 26,4 x 3,8 cm



● 159



Pour séparer- Thermobarrier

- S'utilisent pour combler l'espace vide et minimiser la perte de température dans les compartiments partiellement chargés.



300DIV

Plaque de séparation de température pour 300MPC, 1318MTC et UPC600

53 x 33 x 2,5 cm



● 157



400DIV

Plaque de séparation de température pour UPC400, UPC800 et UPCS400

54 x 33 x 3,8 cm



● 180

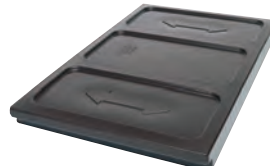

1200DIV

Plaque de séparation de température pour UPC1200

53 x 33,5 x 3,5 cm



● 131



1600DIV

Plaque de séparation GN 2/1 pour para Camkiosk

53 x 33,5 x 3,8 cm



● 401

Tous les articles en **gras** sont des produits de stock habituel. Consulter les couleurs disponibles.

Accessoires (suite)

Pour le chaud- Camwarmer



- Soyez sûr que les aliments chauds, le resteront durant le stockage et le transport

HP3253

Plaque chaude Camwarmer GN 1/1 pour EPP160, EPP180, EPP180LH, EPP300 et EPP400

53 x 32,5 x 3 cm

🗑️ 1

● 444



1210PW

Plaque chaude Camwarmer pour UPC600, UPC800, UPC800SP

34,9 x 27,6 x 4 cm

🗑️ 1

● 191



Pour le transport - Camdolly



CD300

Socle rouleur UPC300 et 1318CC

65 x 49 x 26,5 cm - 136 kg

🗑️ 1

● 110 ● 131 ● 157 ● 401



CD400

Socle rouleur UPC400 et UPCS400

53 x 70 x 23 cm - 136 kg

🗑️ 1

● 110 ● 131 ● 157 ● 401



400STP

Sangle pour UPC400 et UPCS400

500 cm de largo

🗑️ 1



Accédez aux principaux outils de Cambro

L'application Cambro vous donne instantanément accès aux principaux outils et aux ressources de Cambro.

De la personnalisation d'un plateau jusqu'à la découverte de la gamme complète de conteneurs de Cambro.

<https://www.cambro.com/app/>



Tous les prix sont indiqués en P.V.P. unitaire.

Chariots isothermes

- Chariots grande capacité à double compartiment qui permettent de garder les aliments chauds ou froids pendant le transport.
- Robuste coque en polyéthylène et épaisse couche isolante en mousse dans toutes les parois et entre les compartiments.
- Les joints hermétiques amovibles conservent les aliments à des températures salubres des heures durant.
- Les systèmes durables de fermeture en nylon des portes s'ouvrent facilement et se ferment solidement.
- Les poignées moulées permettent une manœuvre facile.
- Les pare-chocs moulés évitent d'abîmer les murs, le mobilier et le matériel.



Conservation de la chaleur

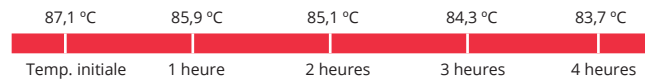

Conservation du froid

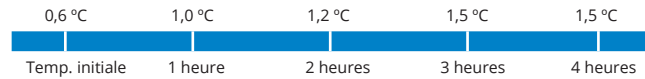

REMARQUE : Si vous utilisez des bacs métalliques pour les aliments, réduisez la température à 120 °C avant de les placer sur les glissières.



UPC600

Chariot isotherme GN Camcart®

52 x 69 x 114,5 cm - 2 bacs, GN 1/1 de 20 cm, prof. ou 4 bacs, GN 1/1 de 15 cm, prof. ou 6 bacs, GN 1/1 de 10 cm, prof. ou 8 bacs, GN 1/1 de 6,5 cm, prof.



● 110 ● 131 ● 157 ● 158
● 159 ● 186 ● 191 ● 192
● 194 ● 401 ● 402



UPC800

Chariot isotherme GN Camcart®

52 x 69 x 137 cm - 4 bacs, GN 1/1 de 20 cm, prof. ou 6 bacs, GN 1/1 de 15 cm, prof. ou 8 bacs, GN 1/1 de 10 cm, prof. ou 12 bacs, GN 1/1 de 6,5 cm, prof.



● 110 ● 131 ● 157 ● 158
● 159 ● 186 ● 191 ● 192
● 194 ● 401 ● 402



UPC1200

Chariot isotherme GN Camcart®

72,5 x 82 x 116 cm - 4 bacs, GN 1/1 de 20 cm, prof. ou 8 bacs, GN 1/1 de 15 cm, prof. ou 12 bacs, GN 1/1 de 10 cm, prof. ou 16 bacs, GN 1/1 de 6,5 cm, prof.



● 110 ● 131 ● 157 ● 158
● 159 ● 186 ● 191 ● 192
● 194 ● 401 ● 402



UPC1600

Chariot isotherme GN Camcart®

71,5 x 82 x 135 cm - 8 bacs, GN 1/1 de 20 cm, prof. ou 12 bacs, GN 1/1 de 15 cm, prof. ou 16 bacs, GN 1/1 de 10 cm, prof. ou 24 bacs, GN 1/1 de 6,5 cm, prof.



● 110 ● 131 ● 157 ● 158
● 159 ● 186 ● 191 ● 192
● 194 ● 401 ● 402

Guide de capacité

Camcart

UPC600	UPC800	UPC1200	UPC1600
8 GN 1/2 - 6,5 cm prof.	12 GN1/1 - 6,5 cm prof.	16 GN1/1 - 6,5 cm prof.	24 GN 1/1 - 6,5 cm prof.
6 GN1/1 - 10 cm prof.	8 GN1/1 - 10 cm prof.	12 GN1/1 - 10 cm prof.	16 GN 1/1 - 10 cm prof.
4 GN1/1 - 15 cm prof.	6 GN1/1 - 15 cm prof.	8 GN1/1 - 15 cm prof.	12 GN 1/1 - 15 cm prof.
2 GN1/1 - 20 cm prof.	4 GN1/1 - 20 cm prof.	4 GN1/1 - 20 cm prof.	8 GN 1/1 - 20 cm prof.

Tous les articles en **gras** sont des produits de stock habituel. Consulter les couleurs disponibles.



Ultra Pan Carrier

- Conçues pour la conservation électrique des aliments chauds et le transport non électrique.
- Consommation d'énergie sensiblement inférieure à celle des unités métalliques comparables.
- Conservent les aliments chauds et sûrs pendant 4 heures après avoir été débranchés.



Conservation de la chaleur quand l'unité est débranchée

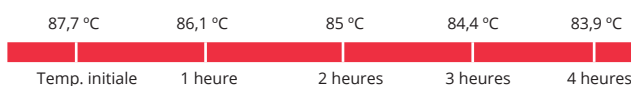

REMARQUE : Si vous utilisez des bacs métalliques pour les aliments, réduisez la température à 120 °C avant de les placer sur les glissières.



UPCH4002

Conteneur isotherme à porte chaude

46 x 67 x 63 cm - 2 bacs, GN 1/1 de 20 cm, prof. ou 3 bacs, GN 1/1 de 15 cm, prof. ou 4 bacs, GN 1/1 de 10 cm, prof. ou 6 bacs, GN 1/1 de 6,5 cm, prof.



● 110 ● 131 ● 191 ● 192 ● 401



UPCHW4002

Conteneur isotherme à porte chaude sur roues

46 x 67 x 79,4 cm - 2 bacs, GN 1/1 de 20 cm, prof. ou 3 bacs, GN 1/1 de 15 cm, prof. ou 4 bacs, GN 1/1 de 10 cm, prof. ou 6 bacs, GN 1/1 de 6,5 cm, prof.



● 110 ● 131 ● 191 ● 192 ● 401



UPCHD4002

Porte chaude pour UPCH4002 et UPCHW4002

53,3 x 49 x 9 cm



● 110 ● 131 ● 191 ● 192 ● 401

Rejoignez-nous



@DbmarkTweet



@dbmarkhosteleria



@dbmark_inst

Tous les prix sont indiqués en P.V.P. unitaire.

Ultra Pan Carrier



UPCH8002

Chariot isotherme à portes chaudes

52 x 69 x 137,2 cm - 4 bacs, GN 1/1 de 20 cm, prof. ou 6 bacs, GN 1/1 de 15 cm, prof. ou 8 bacs, GN 1/1 de 10 cm, prof. ou 12 bacs, GN 1/1 de 6,5 cm, prof.



● 110 ● 131 ● 191
● 192 ● 401



UPCHT8002

Chariot isotherme à porte supérieure chaude

52 x 69 x 137,2 cm - 4 bacs, GN 1/1 de 20 cm, prof. ou 6 bacs, GN 1/1 de 15 cm, prof. ou 8 bacs, GN 1/1 de 10 cm, prof. ou 12 bacs, GN 1/1 de 6,5 cm, prof.



● 110 ● 131 ● 191
● 192 ● 401



UPCHTD8002

Porte supérieure chaude pour UPCHT8002 y UPCHT8002

53,3 x 46 x 9 cm



● 110 ● 131 ● 191
● 192 ● 401



UPCHBD8002

Porte inférieure chaude pour UPCH8002

53,3 x 46 x 9 cm



● 110 ● 131 ● 191
● 192 ● 401



UPCH16002

Chariot isotherme à portes chaudes

73 x 84,7 x 137,5 cm - 8 bacs, GN 1/1 de 20 cm, prof. ou 12 bacs, GN 1/1 de 15 cm, prof. ou 16 bacs, GN 1/1 de 10 cm, prof. ou 24 bacs, GN 1/1 de 6,5 cm, prof.



● 110 ● 131 ● 191
● 192 ● 401



UPCHT16002

Chariot isotherme à porte supérieure chaude

73 x 84,7 x 137,5 cm - 8 bacs, GN 1/1 de 20 cm, prof. ou 12 bacs, GN 1/1 de 15 cm, prof. ou 16 bacs, GN 1/1 de 10 cm, prof. ou 24 bacs, GN 1/1 de 6,5 cm, prof.



● 110 ● 131 ● 191
● 192 ● 401



UPCHTD16002

Porte supérieure chaude pour UPCH16002

53,3 x 66,8 x 10,8 cm



● 110 ● 131 ● 191
● 192 ● 401



UPCHBD16002

Porte inférieure chaude pour UPCH16002

53,3 x 66,8 x 10,8 cm



● 110 ● 131 ● 191
● 192 ● 401

Guide de capacité

Ultra Pan Carrier 1 comp.	Ultra Pan Carrier 2 comp - Gamme 800	Ultra Pan Carrier 2 comp - Gamme 1600
UPCH4002	UPCH8002	UPCH16002
6 GN 1/1 - 6,5 cm prof.	12 GN 1/2 - 6,5 cm prof.	24 GN1/1 - 6,5 cm prof.
4 GN1/1 - 10 cm prof.	8 GN1/1 - 10 cm prof.	16 GN1/1 - 10 cm prof.
3 GN1/1 - 15 cm prof.	6 GN1/1 - 15 cm prof.	12 GN1/1 - 15 cm prof.
2 GN1/1 - 20 cm prof.	4 GN1/1 - 20 cm prof.	8 GN1/1 - 20 cm prof.
UPCHW4002	UPCHT8002	UPCHT16002
6 GN 1/2 - 6,5 cm prof.	12 GN 1/2 - 6,5 cm prof.	24 GN1/1 - 6,5 cm prof.
4 GN1/1 - 10 cm prof.	8 GN1/1 - 10 cm prof.	16 GN1/1 - 10 cm prof.
3 GN1/1 - 15 cm prof.	6 GN1/1 - 15 cm prof.	12 GN1/1 - 15 cm prof.
2 GN1/1 - 20 cm prof.	4 GN1/1 - 20 cm prof.	8 GN1/1 - 20 cm prof.

Tous les articles en **gras** sont des produits de stock habituel. Consulter les couleurs disponibles.



Pro Cart Ultra (électrique chaud, froid et passif) 60 x 40

- Premier chariot de transport qui maintient les aliments chauds et froids dans un seul chariot.
- Chariot de grande capacité pour contenir des bacs d'alimentation GN, bacs plats 60 x 40 cm, plateaux et boîtes de pizza dans deux compartiments indépendants et isolés.
- Les modules actifs sont d'une grande efficacité énergétique et consomment moins de 5 ampères chacun.
- Le module froid utilise une technologie thermoélectrique respectueuse de l'environnement.
- Même sans électricité, ce chariot peut maintenir des températures sûres pendant plus de 4 heures.



Chaud : perte de température de 1,5° C/heure en moyenne.

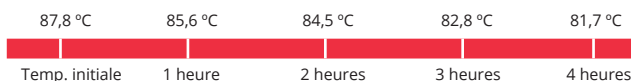

Froid : gain de température de 0,4° C/heure en moyenne.

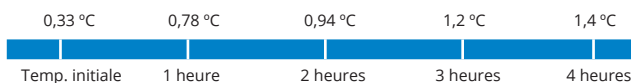

Porte sans joint

Moins de pièces de rechange pour faciliter le nettoyage.
Ouverture à 270° de la porte

Extérieure en polyéthylène

conserve les teneurs en humidité naturelle des aliments et reste froid au toucher pendant l'utilisation, contrairement aux unités métalliques

Roues standard ultrarésistantes 15 x 5 cm

Deux roues haute performance non marquantes et entièrement pivotantes avec freins à l'avant et deux roues rigides à l'arrière pour faciliter le positionnement et le déplacement



Charnières en nylon de 10 cm et réglables

Permettent d'ouvrir et refermer rapidement la porte et maintiennent le contenu en sécurité pendant le transport (la porte est verrouillée)

Charnières en acier inoxydable

Pare-chocs moulés évitent d'abîmer les murs, le mobilier et le matériel

Tous les prix sont indiqués en P.V.P. unitaire.

Pro Cart Ultra (elétricos caliente, frío et pasivo) (suite)

Neutre / passif 60 x 40

PCUPP4

Chariots 60 x 40 à compartiments neutres

71,1 x 90,8 x 167,6 cm



● 615



PCULP4

Chariot à compartiment neutre

71,1 x 92,7 x 101,6



● 615



Électrique chaud et froid 60 x 40



PCUHH4

Chariot 60 x 40, deux compartiments électriques chauds 220V

71 x 92,7 x 167,6 cm



● 615



PCUCC4

Chariot 60 x 40, deux compartiments électriques froids 220V

71 x 92,7 x 167,6 cm



● 615



PCUHC4

Chariot 60 x 40, deux compartiments électriques : supérieur chaud, inférieur froid 220V

71 x 92,7 x 167,6 cm



● 615



PCULH4

Chariot à compartiment chaud 220V

71,1 x 90,8 x 101,6 cm



● 615



PCULC4

Chariot à compartiment froid 220V

71,1 x 90,8 x 101,6 cm



● 615



Accessoires

SSR1

1 paire de glissières



● INOX.

SSR8

8 paires de glissières



● INOX.

Tous les articles en **gras** sont des produits de stock habituel. Consulter les couleurs disponibles.

Kit d'attelage pour chariot Pro Cart Ultra

La barre d'attelage est conçue pour connecter votre chariot Pro Cart Ultra de manière sûre à n'importe quel véhicule équipé d'une possibilité de remorquage. S'adapte à tous les modèles Pro Cart Ultra, bas et hauts, fabriqués après janvier 2019.



PCUTOW

Remorque pour chariots Pro Cart Ultra
Kit standard

1

615

PCUTOWSP

Remorque pour chariots Pro Cart Ultra
Kit de sécurité - verrou à clé

1

615

Chariots isothermes pour plateaux, plaques ou boîtes

- Utilisez-les pour les aliments en vrac, chauds, froids, en plateaux, plaques ou boîtes.
- Robuste coque en polyéthylène et épaisse couche isolante en mousse dans toutes les parois et entre les compartiments.
- Les systèmes de fermetures en plastique inoxydable sont fixés à des plaques de montages moulées.

REMARQUE : Refroidissez les plaques en métal à une température de 120 °C avant de les poser sur les glissières.



Chaud - Perte moyenne de température chaude : 16,11 °C/heure

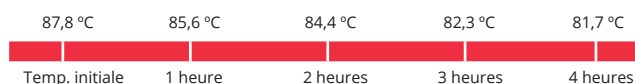

Froid - Gain moyen de température froide : 16,94 °C/heure

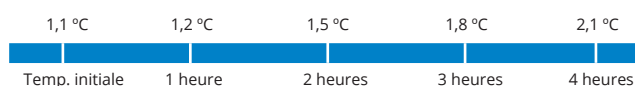

Guide de capacité

Combo Cart Plus électrique	Combo Cart Plus neutre	Camcart - plateaux, plaques et boîtes
CMBPH2	CMBP	1826DTC
14 plaques taille standard	14 plaques taille standard	24 plateaux et plaques
28 plaques format moyen	28 plaques format moyen	1826DBC, 1826DBCSP, 1826LBC, 1826LBCSP
20 plateaux GN 1/1 - 6,5 cm prof.	20 plateaux GN 1/1 - 6,5 cm prof.	Boîtes d'aliments
14 plateaux 40 x 60 cm	14 plateaux 40 x 60 cm	1826LTC, 1826LTCSP
14 boîtes grand format de pizza	14 boîtes grand format de pizza	13 plateaux et plaques
CMBPLH2	CMBPL	1826LTC3
7 plaques taille standard	7 plaques taille standard	7 plateaux et plaques
14 plaques format moyen	14 plaques format moyen	1826MTC
10 plateaux GN 1/1 - 6,5 cm prof.	10 plateaux GN 1/1 - 6,5 cm prof.	6 plateau et plaques
7 plateaux 40 x 60 cm	7 plateaux 40 x 60 cm	
7 boîtes grand format de pizza	7 boîtes grand format de pizza	

Tous les prix sont indiqués en P.V.P. unitaire.

■ Chariots isothermes pour plateaux, plaques et boîtes (suite)

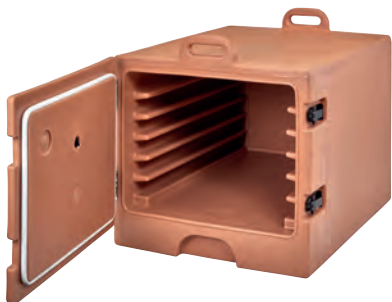

1826MTC

Camcarts® Chariot isotherme pour plateaux, plaques et boîtes
55 x 74,5 x 57 cm - 6 plateaux et plaques



● 110 ● 131 ● 191 ● 192 ● 401



1826LTC

Camcarts® Chariot isotherme pour plateaux, plaques et boîtes
55 x 81,5 x 95,5 cm - 13 plateaux et plaques



● 110 ● 131 ● 191 ● 192 ● 401



1826LTC3

Camcarts® Chariot isotherme pour plateaux, plaques et boîtes
55 x 81,5 x 95,5 cm - 7 plateaux et plaques



● 110 ● 131 ● 191 ● 192 ● 401



1826LBC

Camcarts® Chariot isotherme
55 x 81,5 x 95,5 cm - Bacs alimentaires de 46 x 66 cm



● 110 ● 131 ● 191 ● 192 ● 401



1826LTCSP

Camcarts® Chariot isotherme avec pack sécurité pour plateaux, plaques et boîtes
55 x 81,5 x 95,5 cm - 13 plateaux et plaques



● 110 ● 131 ● 191 ● 192 ● 401



1826LBCSP

Camcarts® Chariot isotherme avec pack sécurité pour plateaux, plaques et boîtes
55 x 81,5 x 95,5 cm - Bacs alimentaires de 46 x 66 cm



● 110 ● 131 ● 191 ● 192 ● 401

■ Conteneurs isothermes pour plaques

- Prévus pour l'industrie pâtisnière et boulangère.
- Idéal pour transporter des produits à températures froides en sécurité.
- Parfait pour les articles pour le four et les pâtes surgelées.
- Fabriqué avec une coque en polyéthylène et épaisse couche isolante en mousse dans toutes les parois et entre les compartiments.
- Aptes pour plaques : 60 x 40 cm, 58 x 40 cm, 58 x 20 cm, 58 x 10 cm.



Tous les articles en **gras** sont des produits de stock habituel. Consulter les couleurs disponibles.

■ Conteneurs isothermes pour plaques (suite)



BK60406

Conteneur isotherme pour plaques avec 6 glissières

76,5 x 57 x 82 cm



186



BK60407

Conteneur isotherme pour plaques avec 7 glissières

76,5 x 57 x 82 cm



186



CD300

Socle rouleur 300MPC et 1318MTC

65 x 49 x 26,5 cm - 136 kg



110 131 157 401

CP6040

Plaque eutectique froide

60 x 40 x 4 cm



159

WR60406

Panier avec 6 glissières

66 x 40,5 x 5,8 cm



WR60407

Panier avec 7 glissières

66 x 40,5 x 5,8 cm



■ Chariots pour le service de boissons et d'alimentation

Distribuer les plateaux repas dans les hôpitaux et les maisons de retraite avec un de nos chariots de service. Différentes capacités pour bacs et plateaux type 1520 ou 1418.



MDC24

Chariot pour le service de boissons à relief pour 3 conteneurs et paniers à condiments

113 x 76 x 112 cm



191 192 401



MDC24F

Chariot pour le service de boissons sans relief

113 x 76 x 112 cm



191 192 401



Tous les prix sont indiqués en P.V.P. unitaire.



MDC1520S20

Chariot de distribution de plateaux repas
96,5 x 146 x 110 cm - 20 plateaux
de 38 x 51,5 cm



● 191 ● 192 ● 194 ● 401



MDC1418S20

Chariot de distribution de plateaux repas
83 x 123,5 x 112 cm - 20 plateaux
de 36 x 46 cm



● 191 ● 192 ● 194 ● 401



MDC1520T30

Chariot de distribution de plateaux repas
74,5 x 152,5 x 162 cm - 30 plateaux
de 38 x 51,5 cm



● 191 ● 192 ● 194 ● 401



MDC1520T16

Chariot de distribution
de plateaux repas
100 x 78,5 x 148 cm
16 plateaux de 38 x 51,5 cm



● 191 ● 192 ● 194 ● 401



MDC1418T30

Chariot de distribution
de plateaux repas
74,5 x 152,5 x 162 cm
30 plateaux de 36 x 46 cm



● 191 ● 192 ● 194 ● 401



MDC1418T16

Chariot de distribution
de plateaux repas
92,7 x 71,1 x 147,6 cm
16 plateaux de 36 x 46 cm



● 191 ● 192 ● 194 ● 401



MDC1411T60

Chariot de distribution
de plateaux repas
74,3 x 152,4 x 161,6 cm
60 plateaux de 36,5 x 26,8 cm



● 191 ● 192 ● 194 ● 401

Tous les articles en **gras** sont des produits de stock habituel. Consulter les couleurs disponibles.

Vaisselle isotherme

Avec la vaisselle isotherme Shoreline vous pourrez maintenir les aliments chauds plus longtemps, pour qu'ils puissent être servis en excellent état tout en gardant toutes leurs qualités nutritives.



MDSD9

Dôme isolant isotherme Shoreline
25,9 cm de Ø x 7,3 cm haut.

12

● 110 ● 447 ● 457
● 480 ● 487 ● 497



MDSL9

Dôme isolant isotherme Shoreline
25,9 cm de Ø x 7 cm haut.

12

● 110 ● 447 ● 457
● 480 ● 487 ● 497



MDSL9

Récipient isolant pour plaque thermique
24,3 cm de Ø x 4,6 cm haut.

12

● 110 ● 447 ● 457
● 480 ● 487 ● 497



MDSP9

Plaque thermique
24 cm de Ø x 4,5 cm haut.

12

● 477



HK39B

Base isotherme pour assiettes
24,3 cm de Ø x 4,6 cm haut.

12

● 110 ● 447 ● 457
● 480 ● 487 ● 497



MDSM8

Chope grand format isotherme Shoreline
8,9 cm de Ø x 10,2 cm haut.
240 ml

48

● 110 ● 447 ● 457
● 480 ● 487 ● 497



MDSB5

Petit bol isotherme Shoreline
8,9 cm de Ø x 6 cm haut.
150 ml

48

● 110 ● 447 ● 457
● 480 ● 487 ● 497



MDSB9

Grand bol isotherme Shoreline
11,1 cm de Ø x 6 cm haut.
270 ml

48

● 110 ● 447 ● 457
● 480 ● 487 ● 497



MDSB16

Bol pour entrée isotherme Shoreline
13,3 cm de Ø x 6 cm haut.
470 ml

48

● 110 ● 447 ● 457
● 480 ● 487 ● 497



MDSPL

Lève-plat thermique Camtherm
8 cm de Ø x 7 cm haut.

1

●



CLRWSR36

Panier de lavage-stockage de 36 couvercles réutilisables
20,96 x 45,4 x 13,97 cm

4

● 452

Tous les prix sont indiqués en P.V.P. unitaire.

LAVAGE, TRANSPORT ET RANGEMENT

8



Tout aussi important que de choisir la bonne vaisselle ou la bonne verrerie, les matériels et équipements pour la protéger et en prendre soin constituent un investissement qu'il ne faut pas négliger. Les casiers de lavage et les chariots de transport de vaisselle de chez CAMBRO sont des éléments indispensables pour le plus grand soin de vos assiettes et verres à pieds. Grâce aux casiers de lavage fermés vous pourrez laver, transporter, protéger et stocker la verrerie en évitant tout coûts supplémentaires de manutention, de bris et de re-lavage. Les chariots de transport de vaisselle sont parfaits pour le stockage et la mise en place d'événements dans les salles de banquet et les hôtels. De plus, le reste des solutions proposées par CAMBRO rendra votre travail plus facile et plus productif.

Les chariots de service ouverts

Les chariots de service CAMBRO sont conçus pour le service et les tâches d'appoint les plus lourdes, en cuisine ou en salle. Polyvalent, durable et fiable, "ce cheval de labour" se prête à tous les usages.



BC225

Chariot de service robuste et ouvert avec 2 roues fixes et étagères de 56 x 39,5 cm

71 x 41 x 82 cm



Couleurs disponibles :

● 191

Couleurs sur commande :

● 110 ● 131
● 157 ● 401

BC2254S

Chariot de service robuste et ouvert avec 4 roues pivotantes et étagères de 56 x 39,5 cm

71 x 41 x 82 cm



Couleurs disponibles :

● 191

Couleurs sur commande :

● 110 ● 131
● 157 ● 401

BC235

Chariot de service robuste et ouvert avec deux roues fixes et étagères de 79 x 52 cm

95 x 55 x 88 cm



Couleurs disponibles :

● 191

Couleurs sur commande :

● 110 ● 131
● 157 ● 401

BC2354S

Chariot de service robuste et ouvert avec 4 roues pivotantes et étagères de 79 x 52 cm

95 x 55 x 88 cm



Couleurs disponibles :

● 191

Couleurs sur commande :

● 110 ● 131
● 157 ● 401

BC230

Chariot de service robuste et ouvert avec deux roues fixes et étagères de 69 x 49,5 cm

84,5 x 51 x 88 cm



Couleurs disponibles :

● 191

Couleurs sur commande :

● 110 ● 131
● 157 ● 401

BC2304S

Chariot de service robuste et ouvert avec 4 roues pivotantes et étagères de 69 x 49,5 cm

84,5 x 51 x 88 cm



Couleurs disponibles :

● 191

Couleurs sur commande :

● 110 ● 131
● 157 ● 401

BC330

Chariot de service robuste fermé avec 2 roues fixes et étagères de 69 x 46,5 cm

84,5 x 51 x 88 cm



Couleurs disponibles :

● 191

Couleurs sur commande :

● 110 ● 131
● 157 ● 401



BC3304S

Chariot de service robuste fermé avec 4 roues pivotantes et étagères de 69 x 46,5 cm

84,5 x 51 x 88 cm



Couleurs disponibles :

● 191

Couleurs sur commande :

● 110 ● 131
● 157 ● 401



BC11TC

Poubelle pour chariot de service

20,6 x 35 x 53,7 cm
42 L



● 110 ● 131



BC1115SH

Panier à couverts pour chariot de service

15,2 x 38,8 x 13,7 cm
6,6 L



● 110 ● 131



Tous les prix sont indiqués en P.V.P. unitaire.



■ Chariot de service Pro

Design moderne et fabrication durable d'une seule pièce de polyéthylène. Chaque étagère supporte un poids de 90,7 kg. Facile à nettoyer. Augmentez l'espace avec les conteneurs optionnels.

SC337

Chariot de service Pro
Chariot de service pro
2 roues fixes, 2 roues
pivotantes avec frein.
60,3 x 105,4 x 94,3 cm (ext.)

🗑️ 1

● 110 ● 131 ● 615



SC337S

Chariot de service Pro
4 roues pivotantes avec frein.
60,3 x 105,4 x 94,3 cm (ext.)

🗑️ 1

● 110 ● 131 ● 615



QCSB

Petit bac de raccordement
rapide
17,8 x 40,6 x 30,9 cm (ext.)

🗑️ 1

● 110



QCTB

Grand bac de raccordement
rapide
17,8 x 40,6 x 54 cm (ext.)

🗑️ 1

● 110



Tous les articles en **gras** sont des produits de stock habituel. Consulter les couleurs disponibles.

Chariots de service KD

Utilisez nos chariots de service KD comme support pour toutes vos opérations, en cuisine et en salle. Ils sont légers, très faciles à monter, avec un design très actuel et adaptés à tous les budgets.

Chaque étagère peut recevoir un **casier à vaisselle** ainsi que deux bacs à vaisselle de taille standard.

Consulter les pièces de rechange pour ces articles dans le chapitre **PIÈCES DE RECHANGES**



Rebords qui empêchent les articles de tomber

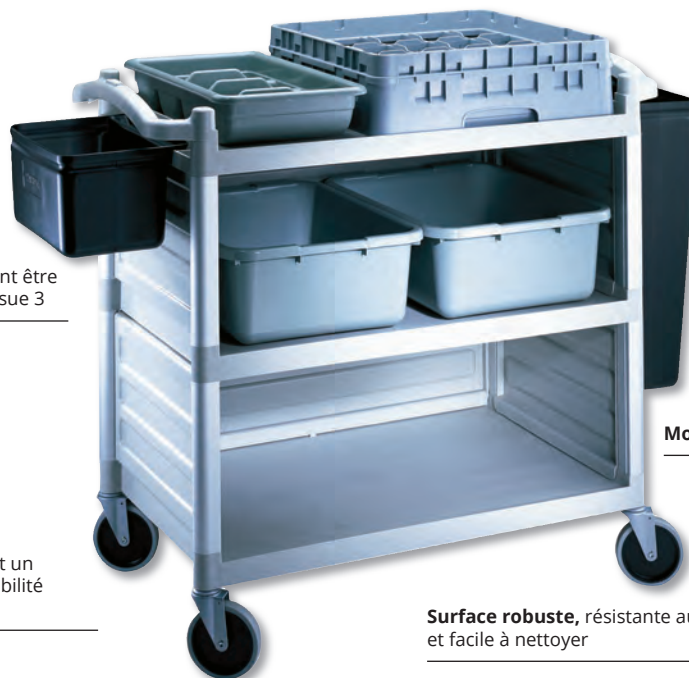

Les **panneaux optionnels** peuvent être ajoutés pour fermer une étagère sur 3

Montants en aluminium très solide

4 roues pivotantes en acier avec revêtement granulé assurent un transport silencieux et une maniabilité constante.

Surface robuste, résistante aux taches et facile à nettoyer

BC331KD

Chariot de service léger et étagères de 62 x 40 cm
96,5 x 41 x 83,5 cm



● 110 ● 480



BC340KD

Chariot de service léger et étagères de 80 x 52 cm
101,5 x 54 x 95 cm



● 110 ● 480



BC331KDTC

Poubelle pour chariots légers

24 x 33 x 56 cm - 30 L



● 110



BC331KDSH

Panier à couverts pour chariots légers

24 x 33 x 18,5 cm - 9,5 L



● 110



BC340KDP*

Jeu de panneaux d'étagères pour BC340KD

45 x 80,3 x 29,8 cm



● 110 ● 480

* un jeu par étage (2 jeux par charriot)

Tous les prix sont indiqués en P.V.P. unitaire.

Bacs à vaisselle Cambox

Ample variété de bacs d'appoint à usages multiples, du ramassage au transport en passant par le stockage.



415CBP

Panier à couvert

36 x 11,3 x 10,3 cm

12

● 110 ● 131 ● 180



912CBP

Bac à usage multiple

30,6 x 23,3 x 13 cm

12

● 110 ● 131 ● 180



1120CBP

Bac à couverts à 4 compartiments

52 x 28,9 x 9,5 cm

12

● 110 ● 131 ● 180



1524B

Bac à usage multiple à 4 compartiments

54,9 x 30,2 x 9,5 cm

12

● 110



1520CBP

Bac à usage multiple

50,6 x 38,9 x 12,5 cm

12

● 110 ● 131 ● 180



1520CBPF

Bac à fond plat à usage multiple

50,6 x 38,9 x 12,5 cm

12

● 110 ● 131 ● 180



1621CBP

Bac à usage multiple

52 x 39,7 x 12,4 cm

12

● 110 ● 131 ● 180



21155CBP

Bac à usage multiple

51,4 x 38,7 x 12,5 cm

12

● 110 ● 131 ● 180



21157CBP

Bac à usage multiple

51,2 x 38,6 x 17,6 cm

12

● 110 ● 131 ● 180



1722CBP

Bac à usage multiple

55,6 x 42,9 x 12,1 cm

12

● 110 ● 131 ● 180



1120CBR

Bac à couverts à 4 compartiments

52 x 28,9 x 9,5 cm

12

● 110 ● 131



1520CBR

Bac à couverts

50,6 x 38,9 x 12,5 cm

12

● 110 ● 131



21155CBR

Bac à couverts avec poignées

51,4 x 38,7 x 12,5 cm

12

● 110 ● 131



21157CBR

Bac à couverts avec poignées

51,2 x 38,6 x 17,6 cm

12

● 110 ● 131



1722CBR

Bac à couverts

55,6 x 42,9 x 12,1 cm

12

● 110 ● 131

Tous les articles en **gras** sont des produits de stock habituel. Consulter les couleurs disponibles.

Bacs à vaisselle Cambox (suite)



1520CBP

Couvercle pour bac 1520CBP

52 x 40,6 cm

12

148



1722CBP

Couvercle pour bacs 1722CBR et 1722CBP

56,8 x 44 cm

12

148



2115CBP

Couvercle pour bacs 2115CBP et 2115CBR

52 x 39,4 cm

12

148



2115CBR

Couvercle pour bacs 2115CBR et 2115CBP

52 x 39,4 cm

12

148

Chariots à plateaux et couverts

Utilisez un chariot à plateaux et à couverts sur la ligne de self-service, où vos clients pourront facilement sélectionner les couverts et le plateaux.



TDCR12

Chariot à plateaux avec cylindres à couverts

97 x 58 x 105 cm

1

110 131 157
191 192 401



TDC209

Chariot à plateaux sans support à couverts

97 x 58 x 87 cm

1

131 157 191
192 401

8 récipients
transparents
Camwear



TC1418

Chariot à plateaux et à couverts avec 8 bacs

82 x 54 x 116 cm

1

110 131 157
191 192 401



CR12

Support à couverts

82 x 54 x 23 cm

1

110 131 157
191 192 401

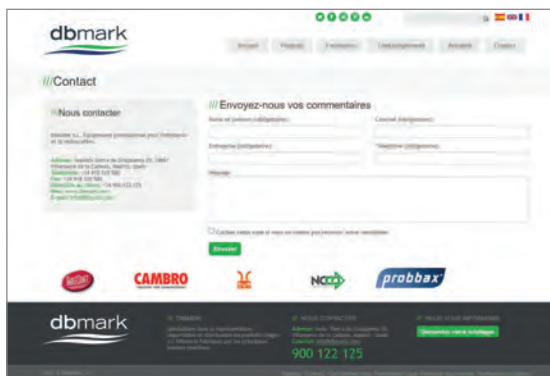

N'hésitez pas à nous consulter.

Dans la section de contact de notre site vous pourrez trouver nos informations de contact (adresse, téléphone, e-mail, etc.).

Vous pouvez également nous poser vos questions ou commentaires.

www.dbmark.com

Tous les prix sont indiqués en P.V.P. unitaire.

Chariots Camdollys

Quand quelque chose fonctionne bien on dit « comme sur des roulettes ». Choisissez le chariot de transport le plus approprié à vos besoins pour déplacer vos casiers, boîtes et conteneurs.



excepté
CDR2020
et CDR202H

Consulter
les pièces de
rechange pour
ces articles
dans le chapitre
**PIÈCES DE
RECHANGES**

CD1826H

Chariot Camdolly pour plaques
et plateaux jusqu'à 46 x 66 cm

51 x 80 x 98 cm - 136 kg



● 110 ● 131 ● 157 ● 401



CD1826HB

Chariot Camdolly pour plaques
et plateaux jusqu'à 46 x 66 cm

59,5 x 85 x 93 cm - 136 kg



● 110 ● 131 ● 157 ● 401



CD1420

Chariot Camdolly
pour cageots et caisses
de 49,5 x 67,5 cm

55,5 x 41,5 x 20,5 cm - 159 kg



● 110 ● 131 ● 157 ● 401



CD2028

Chariot Camdolly
pour cageots et caisses et
UPC100/101/300 UPC400
et 100MPC

56 x 77 x 20,5 cm - 159 kg



● 110 ● 131 ● 157 ● 401



CD1313

Chariot Camdolly cageots
et caisses

41 x 41 x 21,5 cm - 114 kg



● 110 ● 131 ● 157 ● 401



CD1327

Chariot Camdolly cageots
et caisses

41 x 74,5 x 21,5 cm - 136 kg



● 110 ● 131 ● 157 ● 401



CDR2020

Chariot Camdolly
pour casiers à vaisselle

54 x 54 x 20 cm
159 kg



● 151



CDR2020H

Chariot Camdolly
pour casiers à vaisselle
avec poignée

59 x 54 x 94 cm
159 kg



● 151



CD2020

Chariot Camdolly
pour casiers à vaisselle

57 x 57 x 21 cm
159 kg



● 110 ● 131
● 157 ● 401



CD2020H

Chariot Camdolly
pour casiers à vaisselle
avec poignée

56,6 x 61,5 x 93,5 cm
159 kg



● 110 ● 131
● 157 ● 401



CD2020HB

Chariot Camdolly
pour casiers à vaisselle
avec poignée

66 x 68,5 x 93 cm
159 kg



● 110 ● 131
● 157 ● 401

Tous les articles en **gras** sont des produits de stock habituel. Consulter les couleurs disponibles.

■ Chariots Camdollies (suite)



2030UT

Chariot utilitaire

50 x 81,5 x 98 cm - 272 kg



● 110 ● 131 ● 157 ● 401



2436UTH

Chariot utilitaire

106 x 60,5 x 92 cm - 272 kg



● 110 ● 131 ● 157 ● 401



2436UTHS

Chariot utilitaire et sangles

106 x 60,5 x 92 cm - 272 kg



● 110 ● 131 ● 157 ● 401



CD100

Chariot pour 100MPC,
UPC100 et UPC101

50 x 73 x 27 cm
136 kg



● 110 ● 131
● 157 ● 401



CD160

Chariot pour UPCS140,
UPCS160, UPCSS160
et UPCS180

42 x 62 x 26,5 cm
136 kg



● 110 ● 131
● 157 ● 401



CD300

Chariot pour 300MPC
et 1318MTC

65 x 49 x 26,5 cm
136 kg



● 110 ● 131
● 157 ● 401



CD1826MTC

Chariot pour 1826MTC

89,5 x 61 x 93 cm
159 kg



● 110 ● 131
● 157 ● 401



CD400

Chariot pour UPC400
et UPCS400

53 x 70 x 23 cm
136 kg



● 110 ● 131
● 157 ● 401



CD3253EPP

Chariot Camdolly
pour tous les modèles GN

53 x 32,5 x 3,7 cm



● 158



CD4060EPP

Chariot Camdolly
pour EPP4060 à charge
supérieure et frontale

71 x 51 x 16 cm



● 158



CDC300

Chariot Camdolly
pour UPC300, EPP400,
EPP300, EPP180, EPP160,
EPP140 et EPP180LH

63,4 x 44,1 x 18,5 cm (ext.)
62,5 x 43,4 cm (int.)



● 358



CDC400

Chariot Camdolly
pour UPC400
et EPP180XLT

64,3 x 47 x 18,5 cm (ext.)
63,1 x 46,9 cm (int.)



● 358

Tous les prix sont indiqués en P.V.P. unitaire.



CD100H

Chariot Camdolly pour 100MPC, UC250, UC500, 250LCD, 350LCD, 500LCD

84 x 50 x 92 cm
159 kg



● 110 ● 131
● 157 ● 401



CD100HB

Chariot Camdolly pour 100MPC, UC250, UC500, 250LCD, 350LCD, 500LCD

83,5 x 60 x 93 cm
159 kg



● 110 ● 131
● 157 ● 401



CD1826MTCHB

Chariot Camdolly avec grandes roues pour 1826MTC

88,5 x 70 x 93,5 cm
159 kg



● 110 ● 131
● 157 ● 401



CD300H

Chariot Camdolly pour 300MPC, 1318MTC, UC1000, 1000LCD

48,5 x 76,5 x 92 cm
159 kg



● 110 ● 131
● 157 ● 401



CD300HB

Chariot Camdolly pour 300MPC, 1318MTC, UC1000, 1000LCD

76 x 60 x 92 cm
159 kg



● 110 ● 131
● 157 ● 401

CD1826PDB

Chariot pour boîtes à pizzas
71 x 50,5 x 26 cm - 136 kg



● 110 ● 131 ● 157 ● 401



400STP

Sangles pour UPC400 y UPCS400
500 cm de long



Rejoignez-nous



@DbmarkTweet



@dbmarkhosteleria



@dbmark_inst

Tous les articles en **gras** sont des produits de stock habituel. Consulter les couleurs disponibles.

Chariots de service fixes à assiettes

Consulter les pièces de rechange pour ces articles dans le chapitre PIÈCES DE RECHANGES

Les chariots à vaisselle CAMBRO sont considérés par les grands professionnels de l'hôtellerie comme le meilleur choix pour protéger, stocker et transporter la vaisselle. Ils peuvent accueillir de 240 à 360 assiettes ; il existe des modèles qui prennent en charge des assiettes carrés et certains modèles sont réglables pour s'adapter à différentes tailles d'assiettes. Ils sont fabriqués en une seule pièce, très résistants et durables. Chaque chariot est fourni avec une housse en vinyle.



DC575

Chariot à assiettes fixe de 14,6 cm
83 x 60 x 81 cm - 270-360 assiettes



● 110 ● 131 ● 191 ● 401



DC700

Chariot à assiettes fixe de 14,9 à 17,8 cm
83 x 60 x 81 cm - 270-360 assiettes



● 110 ● 131 ● 191 ● 401



DC825

Chariot à assiettes fixe de 18,1 à 21 cm
73 x 60,5 x 81,5 cm - 180-240 assiettes



● 110 ● 131 ● 191 ● 401

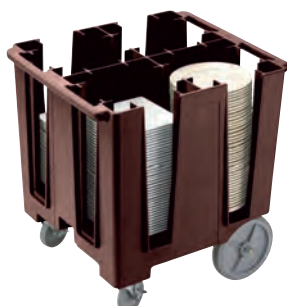

DC950

Chariot Versa pour assiettes rondes de 21,3 à 24,1 cm. et carrées de 18,4 à 20,5 cm

69 x 78 x 81 cm - 225-300 assiettes



● 110 ● 131 ● 480



DCS1125

Chariot Versa pour assiettes rondes de 24,4 à 28,6 cm. et carrées de 21,3 à 24,1 cm

69 x 78 x 81 cm - 180-240 assiettes



● 110 ● 131 ● 480



DC1225

Chariot à assiettes fixe de 28,9 à 31,1 cm

70 x 83 x 81,5 cm - 180-240 assiettes



● 110 ● 131 ● 191 ● 401



Housse de protection en vinyle fournie avec tous nos chariots de service à assiettes pour protéger vaisselle et plateaux

Tous les prix sont indiqués en P.V.P. unitaire.

Chariots de service ajustables



Roue fixe au centre du chariot pour des manoeuvres plus faciles

Consulter les pièces de rechange pour ces articles dans le chapitre **PIÈCES DE RECHANGES**



TDC30

Chariot ajustable pour plateaux et assiettes avec 2 séparateurs
99 x 59 x 88 cm - 240 plateaux



1

● 110 ● 131 ● 157 ● 191 ● 192 ● 401



ADC33

Chariot ajustable pour assiettes à 5 roues - assiettes jusqu'à 33 cm
98,4 x 76,2 x 83,3 cm - 45-60 pièces/colonne



1

● 131 ● 401



ADCS

Chariot ajustable pour assiettes jusqu'à 33 cm
96 x 73 x 81 cm - 45-60 pièces/colonne



1

● 110 ● 131 ● 401 ● 480

Chariots de service compacts et réglables Série S

Le chariot de la Série S est Léger, facile à manoeuvrer et d'accès rapide sur les quatre côtés. Sa conception permet de contenir des assiettes de différentes tailles. Idéal pour les petites et grandes surfaces.



ADCSC

Chariot de service compact et réglable Série S avec 4 tours
68,6 x 68,6 x 80,7 cm



1

● 480



ADCSC avec 4 tours
Colonnes : 5
Taille assiettes : 22,9 cm



ADCSC avec 4 tours
Colonnes : 4
Taille assiettes : 23,5 - 30,5 cm



Tous les articles en **gras** sont des produits de stock habituel. Consulter les couleurs disponibles.

Casiers de lavage

De même que les chariots à assiettes, les casiers de lavage CAMBRO sont la meilleure option pour le soin et la protection de votre verrerie.

Rangez vos verres par couleur, en choisissant entre les 12 couleurs qu'offre DBMARK

● 108 ● 110 ● 119 ● 151 ● 163 ● 167 ● 168 ● 180 ● 184 ● 186 ● 414 ● 416

diamètre maximum



haut máxima



diamètre maximum
14,8 cm



9 compartiments verres et verres à pied

Code	Hauteur max.	Nb étages
9S318	9,4 cm	1
9S434	13,5 cm	2
9S638	17,6 cm	3
9S800	21,7 cm	4
9S958	25,8 cm	5
9S1114	29,9 cm	6



diamètre maximum
10,9 cm



16 compartiments verres et verres à pied

Code	Hauteur max.	Nb étages
16S318	9,4 cm	1
16S418	11,8 cm	1
16S434	13,5 cm	2
16S534	14,9 cm	2
16S638	17,6 cm	3
16S738	20,0 cm	3
16S800	21,7 cm	4
16S900	24,1 cm	4
16S958	25,8 cm	5
16S1058	28,2 cm	5
16S1114	29,9 cm	6
16S1214	32,3 cm	6



diamètre maximum
9,84 cm



20 compartiments verres et verres à pied

Code	Hauteur max.	Nb étages
20S318	9,4 cm	1
20S418	11,8 cm	1
20S434	13,5 cm	2
20S534	14,9 cm	2
20S638	17,6 cm	3
20S738	20,0 cm	3
20S800	21,7 cm	4
20S900	24,1 cm	4
20S958	25,8 cm	5
20S1058	28,2 cm	5
20S1114	29,9 cm	6
20S1214	32,3 cm	6



diamètre maximum
8,7 cm



25 compartiments verres et verres à pied

Code	Hauteur max.	Nb étages
25S318	9,4 cm	1
25S418	11,8 cm	1
25S434	13,5 cm	2
25S534	14,9 cm	2
25S638	17,6 cm	3
25S738	20,0 cm	3
25S800	21,7 cm	4
25S900	24,1 cm	4
25S958	25,8 cm	5
25S1058	28,2 cm	5
25S1114	29,9 cm	6
25S1214	32,3 cm	6



diamètre maximum
7,84 cm



30 compartiments verres et verres à pied

Code	Hauteur max.	Nb étages
30S318	9,4 cm	1
30S434	13,5 cm	2
30S638	17,6 cm	3
30S800	21,7 cm	4
30S958	25,8 cm	5
30S1114	29,9 cm	6



diamètre maximum
7,2 cm



36 compartiments verres et verres à pied

Code	Hauteur max.	Nb étages
36S318	9,4 cm	1
36S418	11,8 cm	1
36S434	13,5 cm	2
36S534	14,9 cm	2
36S638	17,6 cm	3
36S738	20,0 cm	3
36S800	21,7 cm	4
36S900	24,1 cm	4
36S958	25,8 cm	5
36S1058	28,2 cm	5
36S1114	29,9 cm	6
36S1214	32,3 cm	6

Tous les prix sont indiqués en P.V.P. unitaire.

Casiers de lavage (suite)

49 compartiments verres et verres à pied

Code	Hauteur max.	Nb étages
49S318	9,4 cm	1
49S434	13,5 cm	2
49S638	17,6 cm	3
49S800	21,7 cm	4
49S958	25,8 cm	5
49S1114	29,9 cm	6



diamètre maximum 6,0 cm



Demi-casiers

Option pratique pour réduire le poids des unités transportées et parfaits pour les petits lave-verres.



diamètre maximum 10,3 cm



diamètre maximum 8,8 cm



diamètre maximum 7,3 cm

8 compartiments verres et verres à pied

Code	Hauteur max.	Nb étages
8HS318	9,4 cm	1
8HS434	13,5 cm	2
8HS638	17,6 cm	3
8HS800	21,7 cm	4
8HS958	25,8 cm	5
8HS1114	29,9 cm	6

● 119 ● 151 ● 167 ● 184 ● 186 ● 416

10 compartiments verres et verres à pied

Code	Hauteur max.	Nb étages
10HS318	9,4 cm	1
10HS434	13,5 cm	2
10HS638	17,6 cm	3
10HS800	21,7 cm	4
10HS958	25,8 cm	5
10HS1114	29,9 cm	6

● 119 ● 151 ● 167 ● 184 ● 186 ● 416

17 compartiments verres et verres à pied

Code	Hauteur max.	Nb étages
17HS318	9,4 cm	1
17HS434	13,5 cm	2
17HS638	17,6 cm	3
17HS800	21,7 cm	4
17HS958	25,8 cm	5
17HS1114	29,9 cm	6

● 119 ● 151 ● 167 ● 184 ● 186 ● 416

Clips d'identification

Ce clip permet d'identifier vos casiers de lavage d'un coup d'oeil. Fabriqué en ABS, ces clips sont conçus pour résister à la forte chaleur des lave-vaisselles industriels.

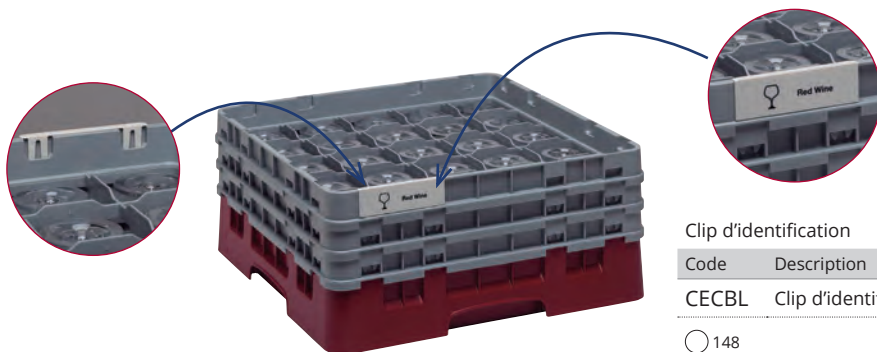

Clip d'identification

Code	Description	UE
CECBL	Clip d'identification vierge	1

○ 148

Tous les articles en **gras** sont des produits de stock habituel. Consulter les couleurs disponibles.

Casiers à assiettes

Utilisez des casiers à assiettes lorsque vous avez besoin de laver, protéger, transporter et stocker un grand nombre d'assiettes, en appliquant le même concept que les casiers à verres.

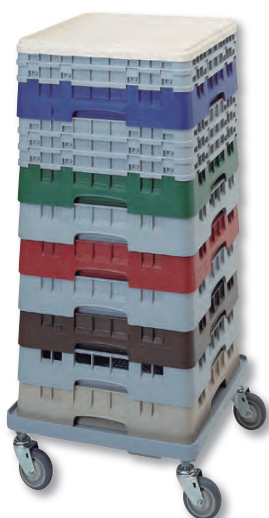

Casiers à assiettes

Code	Description
CP-14820-2	57 assiettes de 148 mm Ø x 20 mm profondeur
CP-17620-3	46 assiettes de 176 mm Ø x 19 mm profondeur
CP-19224-2	36 assiettes de 154 mm Ø x 24 mm profondeur
CP-19224-3	36 assiettes de 195 mm Ø x 24 mm profondeur
CP-22624-4	32 assiettes de 226 mm Ø x 23 mm profondeur
CP-31024-4	21 assiettes de 236 mm Ø x 24 mm profondeur
CP-31024-5	21 assiettes de 277 mm Ø x 24 mm profondeur
CP-31024-6	20 assiettes de 310 mm Ø x 24 mm profondeur
CP-28026-4	20 assiettes de 236 mm Ø x 26 mm profondeur
CP-28026-5	20 assiettes de 277 mm Ø x 26 mm profondeur
CP-28026-6	18 assiettes de 280 mm Ø x 26 mm profondeur
CP-32328-4	18 assiettes de 236 mm Ø x 28 mm profondeur
CP-32328-5	18 assiettes de 277 mm Ø x 28 mm profondeur
CP-32328-6	18 assiettes de 318 mm Ø x 28 mm profondeur
CP-32328-7	18 assiettes de 323 mm Ø x 28 mm profondeur
CP-28031-3	18 assiettes de 195 mm Ø x 31 mm profondeur
CP-28031-4	18 assiettes de 236 mm Ø x 31 mm profondeur
CP-28031-5	18 assiettes de 277 mm Ø x 31 mm profondeur
CP-31334-3	15 assiettes de 195 mm Ø x 34 mm profondeur
CP-31334-4	15 assiettes de 236 mm Ø x 34 mm profondeur
CP-31334-5	15 assiettes de 277 mm Ø x 34 mm profondeur
CP-31334-6	15 assiettes de 310 mm Ø x 34 mm profondeur
CP-31054-3	10 assiettes de 194 mm Ø x 54 mm profondeur
CP-31054-4	10 assiettes de 236 mm Ø x 54 mm profondeur
CP-31054-5	10 assiettes de 277 mm Ø x 54 mm profondeur
CP-31054-6	10 assiettes de 310 mm Ø x 54 mm profondeur

Accessoires

Code	Description
DRC2020	Couvercle casier de lavage - 50 x 50 x 2,4 cm

● 180

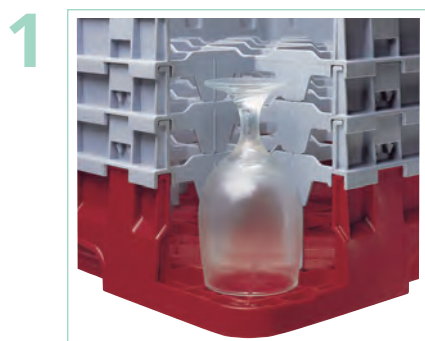

Lavage efficace



Stockage hygiénique

Tous les prix sont indiqués en P.V.P. unitaire.

Casiers de base et porte-verres

Utilisez les casiers de CAMBRO comme support pour vos opérations de lavage. Choisissez le casier de base approprié pour laver la vaisselle, poêles, saladiers et ustensiles de cuisine.

Casier de base

Code	Description
BR258	Casier de base - 10,1 cm haut.
BR414	Avec 1 extension - 14,3 cm haut.
BR578	Avec 2 extensions - 18,4 cm haut.
BR712	Avec 3 extensions - 22,5 cm haut.



CRPHDG2878 Grille de retenue

Demi-casier

Code	Description
HBR258	Casier de base - 10,1 cm haut.
HBR414	Avec 1 extension - 14,3 cm haut.
HBR578	Avec 2 extensions - 18,4 cm haut.
HBR712	Avec 3 extensions - 22,5 cm haut.



Casier à verres

Code	Description	UE
GK2000	35,6 x 45,7 cm - diamètre max. 6,6 cm	12



Casier à tasses

Code	Description	UE
KK1200	35,6 x 45,4 cm - diamètre max. 7,44 cm	12



BR578



CRPHDG2878



HBR578



3



Meilleure gestion des stocks

4



Transport sûr et hygiénique

Tous les articles en **gras** sont des produits de stock habituel. Consulter les couleurs disponibles.

GUIDE DES CASIERS CAMRACK DE CAMBRO POUR VERRES ET VERRES À PIED

Plus de 4.000 modèles de verres et de verres à pied de toutes marques avec le casier de lavage qui correspond et son prix.

Un outil utile qui vous permettra d'économiser du temps et vous aidera à trouver le casier de lavage idéal.

Téléchargez votre guide sur www.dbmark.com

Recherchez vos verres par marque et modèle.
Trouvez le casier qui correspond au diamètre et à la hauteur de votre verre ainsi que son prix.



guide de casiers pour verres et verres à pied 2021

FABRIQUANT	Modèle	Ref. fabricant	Nb Verres	Capacité cl.	Description	CAMBRO	
						Ref. casier	Verre à pied/verres
	DGCO	347129	36	36	SOFT & SHIELD	30554	36
	DGCO	347131	36	36	SOFT & SHIELD	30554	36
	DGCO	347134	36	36	SOFT & SHIELD	30554	36
	DGCO	347137	27	27	SOFT & SHIELD	30554	36
	DGCO	347136	36	36	SOFT & SHIELD	30554	49
	DGCO	481123	23	23	SOFT & SHIELD	30554	49
	DGCO	347130	50	50	SOFT & SHIELD	30554	49
	DGCO	347136	45	45	SOFT & SHIELD	30554	49
	DGCO	371123	23	23	COCKTAIL	30554	9
	DORTLAND	479127	27	27	COCKTAIL	30554	36
	DUNE	353105	5	5	SOFT & SHIELD	30554	36
	DUNE	353125	25	25	SOFT & SHIELD	30554	36
	DUNE	353122	23	23	SOFT & SHIELD	30554	36
	DUNE	353128	28	28	SOFT & SHIELD	30554	36
	DUNE	353123	23	23	SOFT & SHIELD	30554	36
	DUNE	353127	27	27	SOFT & SHIELD	30554	36
	DUNE	353126	35	35	SOFT & SHIELD	30554	36
	EDWARDS	914151	51	51	COCKTAIL	30554	36
	ELITE	914124	24	24	AGUA	30554	36
	ELITE	914126	26	26	COCKTAIL	30554	36
	ELITE	914128	28	28	WINE	30554	36
	ELITE	917113	13	13	VINO BLANCO	30554	36
	GEN	832134	35	35	WINEY ALTO	30554	49
	GEN	832131	31	31	WINEY BOLD	30554	36
	GLAM	2928125	25	25	MARTINI	30554	9
	GRAND CRU	871142	38	38	COCKTAIL	30554	36
	GRAND CRU	871148	38	38	WINE	30554	36
	GUSTO	253140	40	40	COCKTAIL	30554	36
	GUSTO	253145	45	45	COCKTAIL	30554	36
	HANDY	836141	41	41	COCKTAIL	30554	9
	HELANA	719127	7	7	SOFT & SHIELD	30554	36
	HELANA	719128	28	28	SOFT & SHIELD	30554	36
	HELANA	711127	27	27	SOFT & SHIELD	30554	36
	HELANA	711127	27	27	SOFT & SHIELD	30554	36
	HELANA	711128	28	28	SOFT & SHIELD	30554	36
	HELANA	711129	29	29	SOFT & SHIELD	30554	36
	HELANA	711146	46	46	SOFT & SHIELD	30554	36
	IBIZA COFFEE	855122	22	22	HOT DRINKS	30554	36
	IBIZA	855125	25	25	WINEY	30554	36
	IBIZA	855126	26	26	WINEY	30554	36
	JOCKEY CLUB	941114	14	14	MARTINI	30554	9
	LAGOON	835123	23	23	COCKTAIL	30554	36
	LIBA	837125	25	25	SOFT & SHIELD	30554	36
	LIBA	837126	27	27	SOFT & SHIELD	30554	36
	MANGOCOSTA	1159127	27	27	MANGOCOSTA	30554	9

31

À l'instar des chariots à vaisselle, les casiers de lavage de CAMBRO sont le meilleur choix pour le soin et la protection de votre verrerie. Leurs caractéristiques uniques permettent de remplir cinq missions importantes :

- Lavage : compartiments internes ouverts pour une circulation complète de l'eau et des solutions de nettoyage et favorisent le séchage rapide et à fond.
- Protection : les extensions et les séparateurs qui protègent le verre à pied sur toute sa hauteur évitent qu'ils s'entrechoquent.
- Transport : parois externes pleines qui empêchent les contaminants de pénétrer et limitent les risques de casse.
- Stockage : les casiers sont empilables, formant une colonne de rangement sur laquelle poser un couvercle. Pas besoin de housse.
- Classification : DBMARK est l'unique distributeur offrant 11 couleurs pour ordonner et identifier facilement les verres contenus dans chaque casier.

Tous les prix sont indiqués en P.V.P. unitaire.

Casiers de lavage pour tasses, casiers à plats et casiers à couverts

Les casiers à tasses ont un plan incliné qui favorise l'égouttage et assure le séchage rapide et hygiénique. Choisissez les casiers à plats conçus pour laver assiettes, plateaux, poêles, saladiers et cloches de dimensions variées. Utilisez le système de casiers fermés pour stocker et transporter les couverts.



20C258

20 compartiments 11,1 x 8,8 cm

Code	Hauteur max.
20C258	6,6 cm
20C414	10,7 cm

● 151



16C414

16 compartiments 11,1 x 11,1 cm

Code	Hauteur max.
16C258	6,6 cm
16C414	10,7 cm
16C578	14,9 cm

● 151



10HC258

10 compartiments 10,4 x 8,8 cm

Code	Hauteur max.
10HC258	6,6 cm
10HC414	10,7 cm

● 151

Casier à plats

Code	Description
PR314	Casier base 9 x 9 - 10,1 cm haut.
PR500	Avec 1 extension 9 x 9 - 14,3 cm haut.
PR59314	Casier base 5 x 9 - 10,1 cm haut.
PR59500	Avec 1 extension 5 x 9 - 14,3 cm haut.
OETR314	Pour plateaux - 10,1 cm haut.

● 151



PR59314

Casier à couverts

Code	Description
FR258	Taille standard
HFR258	Demi-casier
8FB434	8 comp. - avec anses
8FBNH434	8 comp. - sans anses

● 151



HFR258



8FB434



8FBNH434



Casier à couverts

Code	Description
BR918CUB	400 couverts jusqu'à 23 cm haut.
BR1034CUB	400 couverts jusqu'à 27 cm haut.

● 151



16C258

Casier à tasses

Code	Hauteur max.
16C258	Standard - 16 comp. - 67 mm haut.
20C258	Standard - 20 comp. - 67 mm haut.
8HC258	Demi-casier - 8 comp. - 67 mm haut.
10HC258	Demi-casier - 10 comp. - 67 mm haut.

● 151

Tous les articles en **gras** sont des produits de stock habituel. Consulter les couleurs disponibles.

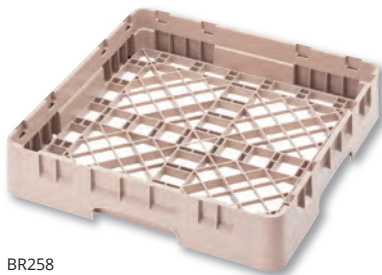

BR258

Casier de base

Code	Hauteur max.
BR258	Standard - 67 mm haut.
HBR258	Demi-casier - 67 mm

- 110 ● 119 ● 151 ● 163 ● 167
- 168 ● 184 ● 186 ● 414 ● 416



E3

Extension ouverte - E3 y HE3

Code	Hauteur max.
E3	Standard
HE3	Demi-casier



25E1

Extension grande profondeur - E1 y GE1

Code	Hauteur max.
9E1	9 compartiments
16E1	16 compartiments
20GE1	20 compartiments
25E1	25 compartiments
30GE1	30 compartiments
36E1	36 compartiments
49E1	49 compartiments

- 151



25E5

Extension mi-profondeur, taille standard - E5

Code	Hauteur max.
16E5	16 compartiments
20GE5	20 compartiments
25E5	25 compartiments
36E5	36 compartiments

- 151



36E2

Extension mi-profondeur - E2

Code	Hauteur max.
9E2	9 compartiments
16E2	16 compartiments
20E2	20 compartiments
20GE2	20 compartiments
25E2	25 compartiments
30GE2	30 compartiments
36E2	36 compartiments
49E2	49 compartiments

- 151



10E1

Extension grande et mi-profondeur - HE1

Code	Hauteur max.
8HE1	8 compartiments
10HE1	10 compartiments
17HE1	17 compartiments

- 151



25E4

Extension grande profondeur, taille standard - E4

Code	Hauteur max.
16E4	16 compartiments
20GE4	20 compartiments
25E4	25 compartiments
36E4	36 compartiments

- 151



10E2

Extension mi-profondeur, mi-largeur - HE2

Code	Hauteur max.
8HE2	8 compartiments
10HE2	10 compartiments
17HE2	17 compartiments

- 151

Tous les prix sont indiqués en P.V.P. unitaire.



La gestion des déchets est un domaine très important dans l'hôtellerie. En travaillant avec les bons matériaux et les fournitures adéquats, vous obtiendrez l'image propre et soignée que vous voulez transmettre à vos clients, sans omettre de gérer de manière pratique, confortable et durable les déchets de votre entreprise.

DBMARK vous offre une solution complète pour la gestion des déchets à l'intérieur et à l'extérieur de votre établissement :

Pour l'extérieur, vous disposez d'une gamme de cendriers avec différentes solutions, comme les totems ou les cendriers muraux compacts.

Pour l'intérieur, nous vous offrons une variété de corbeilles qui s'adaptent aux besoins de tous les services de votre entreprise. Vous trouverez une grande variété de poubelles et de conteneurs de recyclage qui vous offrent la solution idéale pour travailler confortablement dans vos cuisines, entrepôts et bureaux dans le respect de l'environnement.

DBMARK dispose également d'une section d'équipement des sanitaires et de panneaux d'avertissements pour les sols.



■ Cendriers d'extérieur

Solution idéale pour la gestion des déchets de tabac à l'extérieur : cendriers ignifuges avec corps en acier galvanisé et peinture électrostatique qui augmente sa résistance à la corrosion. Faciles et rapides à vider et avec kit de montage inclus. Les cendriers sur pied ont une base lourde qui assure la stabilité du tronc, mais ils comprennent également un kit d'ancrage au sol en option.



AT-0202-DGRY

Cendrier mural

15,2 x 6,4 x 25,5 cm
- 1,5 L



AT-0222-DGRY

Cendrier mural

19,1 x 6,4 x 35,5 cm
- 3 L



AT-0291-DGRY

Cendrier mural
tubulaire

10,2 x 11 x 50 cm - 1 L



AT-0402-MSSTL

Cendrier mural
tubulaire

7,6 cm de Ø x 46 cm
haut. - 1,7 L



AT-0302-ALU

Cendrier mural
tubulaire

8 cm de Ø x 68 cm
haut.
3,4 L



AT-0303-ALU

Cendrier mural tubulaire

8 cm de Ø x 40 cm



AT-0252-DGRY

Cendrier mural

30 x 14 x 67 cm
Interior 14 L et cenicero 3 L



AT-0210-DGRY

Pied pour cendrier
AT-0212-DGRY

25 x 20 x 100 cm



AT-0212-DGRY

Cendrier mural
ou sur pied

10 x 6,4 x 50 cm
1,5 L



Tous les prix sont indiqués en P.V.P. unitaire.

■ Cendriers d'extérieur (suite) 



AT-0292-DGRY

Cendrier tubulaire sur pied - Dôme
30 cm de Ø x 108 cm haut. - 3 L



AT-0232-DGRY

Cendrier sur pied. Totem
40,3 x 26,2 x 104,1 cm - 12,5 L



AT-0262-DGRY

Cendrier tubulaire sur pied avec corbeille
40,3 x 26,2 x 104,1 cm - Cendrier 2 L et corbeille 8 L



AT-1271-DGRY

Cendrier tubulaire sur pied avec corbeille
33 x 28 x 89,5 cm - Cendrier 2,3 L et corbeille 20 L



AT-1271-SIL

Cendrier tubulaire sur pied avec corbeille
33 x 28 x 89,5 cm - 25 L



AT-1272-DGRY

Cendrier sur pied avec corbeille
33 x 30 x 96 cm - Cendrier 3,3 L et corbeille 24 L



AT-1272-SIL

Cendrier sur pied avec corbeille
33 x 30 x 96 cm - 27 L



AT-1273-DGRY

Cendrier sur pied avec corbeille
48 x 25 x 96 cm - 49 L



AT-1273-SIL

Cendrier sur pied avec corbeille
48 x 25 x 96 cm - 49 L



AT-0422-MSSTL

Cendrier tubulaire sur pied avec toit

7,6 cm de Ø x 92 cm haut.
1,1 L



AT-0325-ALU

Cendrier tubulaire sur pied

30 cm de Ø x 99 cm



AT-0990-DGRY

Cendrier sur pied, plastique
35,8 Ø x 95 cm
Plastique ignifuge V0



Tous les articles en **gras** sont des produits de stock habituel. Consulter les couleurs disponibles.



■ Cendrier de table

Nous disposons de plusieurs modèles de cendriers de table, en mélamine noire, rond, à eau ainsi qu'en acier inoxydable.



ST363B-1

Cendrier de table rond
9,8 cm de Ø x 4,5 cm haut.

12



ST365R-1

Cendrier de table rond
9,8 cm de Ø x 4,5 cm haut.

12



263B-1

Cendrier de table rond
10,5 cm de Ø x 4,8 cm haut.

12



131B

Cendrier de table rond
7,9 cm de Ø x 3,5 cm haut.

12



707B

Cendrier de table rond
de mesa

12

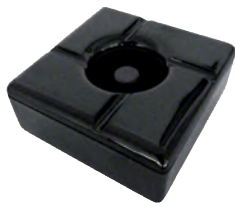

WPA5BK

Cendrier de table carré
à eau
11,4 cm de Ø x 5,1 cm haut.

12



WPA5B

Cendrier de table carré
à eau
11,4 cm de Ø x 5,1 cm haut.

12



WPA5SS

Cendrier de table rond
à eau
11,3 cm de Ø x 3,5 cm haut.

12



Tous les prix sont indiqués en P.V.P. unitaire.



Nouveauté

■ Distributeurs de gel hydroalcooliques

Distributeur de gel hydroalcoolique avec capteur infrarouge haute précision. Fabriqué en ABS et avec une capacité d'environ 1 000 ml. Fonctionne avec 4 piles alcalines type C.



AGD2020

Distributeur

16 x 11,7 x 28,5 cm

ABS

 1

○



THAGD2020

Pied pour table

Base : 18 x 15,5 cm / haut. : 49 cm /
largeur : 9 cm.

Fer

 1

●

FSAGD2020

Pied pour distributeur de gel

Base : 34 x 34 cm / Pied : 155 x 9 cm

Fer

 1

●



Tous les articles en **gras** sont des produits de stock habituel. Consulter les couleurs disponibles.



Nouveauté

■ Conteneurs transparents pour gants et masques usagés



Le petit modèle est parfait pour être installé sur un comptoir ou une étagère. Le grand modèle, d'une hauteur de 75 cm, se place simplement sur le sol. Fabriqué en PMMA (plexiglas) recyclable compatible avec les nettoyants à base d'éthanol <80%.

BR-0025-CLR

Conteneur transparent de 12 L
25 x 30 x 30

PMMA

♻️ 4

○ Clear



BR-0075-CLR

Conteneur transparent de 37 L

Base : 18 x 15,5 cm
Haut. : 49 cm
Largeur : 9 cm.

PMMA

♻️ 4

○ Clear

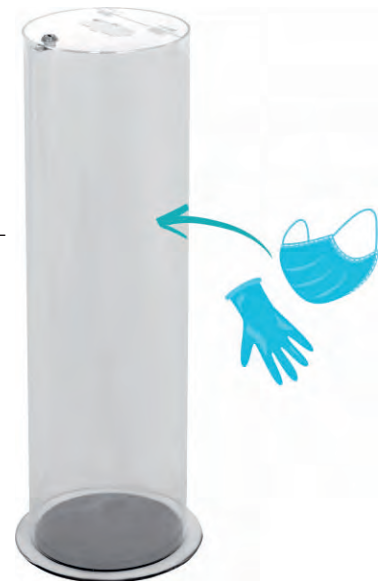

Rejoignez-nous



@DbmarkTweet



@dbmarkhosteleria



@dbmark_inst

Tous les prix sont indiqués en P.V.P. unitaire.



■ Collecteurs de tri Open Dôme

Élégantes poubelles de tri des déchets disponibles en 5 couleurs. Sans bords tranchants. Sa grande ouverture permet de jeter les résidus sans toucher la corbeille.



OD-6140-SBLU

Collecteur de tri Open Dome avec couvercle

38 cm de Ø x 74 cm haut. - 40 L



OD-6140-SGRN

Collecteur de tri Open Dome avec couvercle

38 cm de Ø x 74 cm haut. - 40 L



OD-6140-SRED

Collecteur de tri Open Dome avec couvercle

38 cm de Ø x 74 cm haut. - 40 L



OD-6140-SYEL

Collecteur de tri Open Dome avec couvercle

38 cm de Ø x 74 cm haut. - 40 L



OD-6140-SSSTL

Collecteur de tri Open Dome avec couvercle

38 cm de Ø x 74 cm haut. - 40 L



OD-3352-BLA

Collecteur de tri Open Dome avec couvercle

38 cm de Ø x 88 cm haut. - 56 L



Tous les articles en **gras** sont des produits de stock habituel. Consulter les couleurs disponibles.

■ Collecteurs ronds à pédale

Élégante alternative aux collecteurs en aluminium. Disponibles en 5 capacités 3, 5, 12, 20 et 30 litres. Équipés d'un bac intérieur en plastique amovible avec poignée afin de disposer des contenus de façon hygiénique. Mécanisme de la pédale 100% métallique.



SO-6003-MBLA

Collecteurs ronds à pédale

16,7 cm Ø x 27 cm alto



SO-6005-MBLA

Collecteurs ronds à pédale

20,3 cm Ø x 28,4 cm alto



SO-6030-MBLA

Collecteurs ronds à pédale

29,2 cm Ø x 64 cm alto



■ Corbeilles et collecteurs

Nous vous proposons une grande variété de poubelles au design élégant, contemporain, conçues pour s'adapter à tous les environnements. Fabriquées en différents matériaux et capacités, elles répondront à tous les besoins de votre établissement.



AT-2030-BLA

Borne cendrier pour extérieur couvert

25 cm de Ø x 65 cm haut.
30 L



AT-2030-SSSTL

Borne cendrier pour extérieur couvert

25 cm de Ø x 65 cm haut.
30 L



AT-2030-MSSTL

Borne cendrier pour extérieur couvert

25 cm de Ø x 65 cm haut.
30 L



AT-2030-SIL

Borne cendrier pour extérieur couvert

25 cm de Ø x 65 cm haut.
30 L



SO-6003-MSSTL

Collecteur rond à pédale

17 cm de Ø x 27 cm haut. - 3 L



SO-6005-MSSTL

Collecteur rond à pédale

20,5 cm de Ø x 28,5 cm haut. - 5 L



SO-6012-MSSTL

Collecteur rond à pédale

24,8 cm de Ø x 40 cm haut. - 12 L



SO-6020-MSSTL

Collecteur rond à pédale

29,6 cm de Ø x 44,5 cm haut. - 20 L



SO-6030-MSSTL

Collecteur rond à pédale

29,5 cm de Ø x 65 cm haut. - 30 L



Tous les prix sont indiqués en P.V.P. unitaire.

■ Corbeilles et collecteurs (suite) 



SO-6205-SSSTL
Collecteur rond à pédale
24 x 24 x 31 cm - 5 L



PB-3140-BLA
Collecteur push avec couvercle poussoir
35 cm de Ø x 74 cm haut. - 40 L



PB-3140-MSSTL
Collecteur push avec couvercle poussoir
35 cm de Ø x 74 cm haut. - 40 L



PB-3140-SIL
Collecteur push avec couvercle poussoir
35 cm de Ø x 74 cm haut. - 40 L



PB-3140-SSSTL
Collecteur push avec couvercle poussoir
35 cm de Ø x 74 cm haut. - 40 L



WB-1051-BLA
Corbeille à double paroi
22,5 cm de Ø x 26,6 cm haut. - 10 L



WB-1051-BEI
Corbeille à double paroi
22,5 cm de Ø x 26,6 cm haut. - 10 L



WB-1051-SSSTL
Corbeille à double paroi
22,5 cm de Ø x 26,6 cm haut. - 10 L



WB-1011-MSSTL
Corbeille perforée
20,5 cm de Ø x 29,5 cm haut. - 10 L



WB-1042-BLA
Corbeille simili cuir
22,3 cm de Ø x 28 cm haut. - 10 L



WB-1042-BRN
Corbeille simili cuir
22,3 cm de Ø x 28 cm haut. - 10 L



WB-1251-BLA
Corbeille de tri 3 compartiments amovibles
25,5 cm de Ø x 30,8 cm haut. - 13 L



WB-1251-SSSTL
Corbeille de tri 3 compartiments amovibles
25,5 cm de Ø x 30,8 cm haut. - 13 L



WB-1252-BLA
Corbeille de tri 3 compartiments amovibles
25,5 cm de Ø x 30,8 cm haut. - 13 L



WB-1252-SSSTL
Corbeille de tri 3 compartiments amovibles
25,5 cm de Ø x 30,8 cm haut. - 13 L



Tous les articles en **gras** sont des produits de stock habituel. Consulter les couleurs disponibles.

■ Corbeilles et collecteurs (suite)



WB-1261-BLA

Collecteur de tri
35,5 cm de Ø x 47 cm haut.
40 L



WB-1261-SSSTL

Collecteur de tri
35,5 cm de Ø x 47 cm haut.
40 L



WB-1271-BLA

Collecteur de tri
35,5 cm de Ø x 67 cm haut.
60 L



WB-1271-SSSTL

Collecteur de tri
35,5 cm de Ø x 67 cm haut.
60 L



■ Corbeille de tri à 2 compartiments

Corbeille à deux compartiments amovibles : 1/3 en gris et 2/3 en noir et 6 autocollants livrés avec chaque corbeille.

WB-1253-BLA

Corbeille de tri
25,5 cm Ø x 30 cm
13 L (3,3 L-gris | 6 L-noir)



WB-1253-SSSTL

Corbeille de tri
25,5 cm Ø x 30 cm
13 L (3,3 L-gris | 6 L-noir)



■ Collecteurs à gobelets

Design moderne pour la collecte efficace et exclusive de gobelets ou combinée de gobelets et autres déchets, pour une optimisation de l'espace. Diamètre des tubes : 9 cm, compatibles avec la majorité des tailles de gobelets, de 10 à 30 cl.

PB-3142-BLA

Collecteur à gobelets
40 L



PB-3143-BLA

Collecteur à gobelets et déchets
40 L



Tous les prix sont indiqués en P.V.P. unitaire.



■ Corbeilles et collecteurs (suite)

FR-1002-BLA

Corbeille rectangulaire
en polypropylène résistant
24 x 17 x 26 cm - 6,6 L

 20



FR-1003-BLA

Corbeille rectangulaire
en polypropylène résistant
28 x 21 x 31 cm - 13,21 L

 20



ST-0010-WHT

Collecteur à couvercle
basculant

24,6 x 19,8 x 37,3 cm
10 L

 10



PB-1142-WHT

Collecteur à couvercle
basculant et support
mural

39,5 x 27,6 x 60 cm
40 L

 10



ST-0010-GRY

Collecteur à couvercle
basculant

24,6 x 19,8 x 37,3 cm
10 L

 10



ST-0015-GRY

Collecteur à couvercle
basculant

30,6 x 24,8 x 41,8 cm
15 L

 10



PB-1142-GRY

Collecteur à couvercle
basculant et support
mural

39,5 x 27,6 x 60 cm
40 L

 10



ST-0025-WHT

Collecteur à couvercle
basculant

34,6 x 27,8 x 51,1 cm
25 L

 10



ST-0050-WHT

Collecteur à couvercle
basculant

40,6 x 34 x 66,8 cm
50 L

 10



ST-0025-GRY

Collecteur à couvercle
basculant

30,6 x 24,8 x 41,8 cm
25 L

 10



ST-0050-GRY

Collecteur à couvercle
basculant

40,6 x 34 x 66,8 cm
50 L

 10



Tous les articles en **gras** sont des produits de stock habituel. Consulter les couleurs disponibles.

■ **Collecteurs antimicrobiens**

Fabriqués en plastique recyclé dans lequel un agent antibactérien et antimicrobien a été incorporé. Solution idéale pour disposer facilement et surtout sans contact des déchets aussi indésirables que masques, gants ou tous types d'équipement de protection individuelle usagés destinés à nous protéger de la contamination par COVID-19.



SO-1245-BLA-BASE

Collecteur à pédale sans couvercle

39,5 x 38 x 57,4 cm - 45 L



SO-1290-BLA-BASE

Collecteur à pédale, sans couvercle et avec roues

48,3 x 39 x 79 cm - 90 L



SO-1245-BLA-LID

Couvercle pour collecteur SO-1230-BASE et SO-1245-BASE

41,2 x 40,8 cm



SO-1290-BLA-LID

Couvercle pour collecteur SO-1270-BASE et SO-1290-BASE

50 x 41,2 cm



SO-1230-BASE

Collecteur à pédale sans couvercle

39,5 x 38 x 40,7 cm - 30 L



SO-1270-BASE

Collecteur à pédale sans couvercle

48,3 x 39 x 64 cm - 70 L



Tous les prix sont indiqués en P.V.P. unitaire.

■ Collecteur à pédale

Idéal pour l'élimination des déchets "mains libres", indispensables dans le secteur de la restauration et de la santé. Mécanisme de pédale silencieux et robuste. Les couvercles s'adaptent parfaitement et sont une barrière aux mauvaises odeurs. Grande variété de couleurs pour un tri sélectif. Fabriqués en polypropylène.



SO-1245-BASE

Collecteur à pédale sans couvercle

39,5 x 38 x 57,4 cm - 45 L



SO-1245-LID

Couvercle pour collecteurs SO-1230-BASE et SO-1245-BASE

41,2 x 40,8 x cm



SO-1290-BASE

Collecteur à pédale sans couvercle et roues arrière

48,3 x 39 x 79 cm - 90 L



SO-1290-LID

Couvercle pour collecteurs SO-1270-BASE et SO-1290-BASE

50 x 41,2 x cm



SO-1230-BASE

Collecteur à pédale sans couvercle

39,5 x 38 x 40,7 cm - 30 L



SO-1270-BASE

Collecteur à pédale sans couvercle

48,3 x 39 x 64 cm - 70 L



Vous voulez être au courant?

Venez sur notre site Web
et vous serez tenus informés de nos nouveautés,
nouvelles, promotion, etc.

www.dbmark.com

Tous les articles en **gras** sont des produits de stock habituel. Consulter les couleurs disponibles.

■ Collecteurs roulants de 100 L

Résistance exceptionnelle aux variations de température, grâce à sa fabrication en polypropylène, ces collecteurs sont robustes et durables. Conteneurs faciles à nettoyer et à entretenir.

RO-1100-GRY

Collecteur roulant de 100 L ou 75 kg

53,3 x 51,2 x 85,2 cm



RO-1100-B-LID

Couvercle
bleu pour
RO-1100-GRY

51,2 x 53,3 x 9 cm



RO-1100-Y-LID

Couvercle
bleu pour
RO-1100-GRY

51,2 x 53,3 x 9 cm



RO-1100-R-LID

Couvercle
bleu pour
RO-1100-GRY

51,2 x 53,3 x 9 cm



RO-1100-G-LID

Couvercle
bleu pour
RO-1100-GRY

51,2 x 53,3 x 9 cm



RO-1100-GRY-LID

Couvercle
bleu pour
RO-1100-GRY

51,2 x 53,3 x 9 cm



RO-1100-LGR-LID

Couvercle
bleu pour
RO-1100-GRY

51,2 x 53,3 x 9 cm



RO-1100-GBLU

Base RO-1100-GRY
avec couvercle
RO-1100-B-LID



RO-1100-GGRN

Base RO-1100-GRY
avec couvercle
RO-1100-G-LID



RO-1100-GRED

Base RO-1100-GRY
avec couvercle
RO-1100-R-LID



RO-1100-GYEL

Base RO-1100-GRY
avec couvercle
RO-1100-GYEL-LID



RO-1100-GGRY et RO-1100-GLGR

Base RO-1100-GRY avec couvercle
RO-1100-GRY-LID
Base RO-1100-GRY avec couvercle
RO-1100-LGR-LID



Le couvercle se replie
complètement vers
l'arrière pour aider à
l'élimination des déchets.



La poignée et les roues
facilitent son utilisation.

Tous les prix sont indiqués en P.V.P. unitaire.

■ Conteneurs ronds agréés pour le contact

Resistentes carros diseñados para cargas pesadas, las ruedas giratorias aseguran un transporte fácil et estable. Construidos en polipropileno et con bordes reforzados resistentes a los impactos, son aplilables entre sí et aguantan temperatura desde -29 °C a más de 60 °C.



RC-2003-BLA

Conteneur alimentaire sans couvercle

56 x 49 x 63 cm - 85 L



RC-2003-BLU

Conteneur alimentaire sans couvercle

56 x 49 x 63 cm - 85 L



RC-2003-GRN

Conteneur alimentaire sans couvercle

56 x 49 x 63 cm - 85 L



RC-2003-GRY

Conteneur alimentaire sans couvercle

56 x 49 x 63 cm - 85 L



RC-2005-BLA

Conteneur alimentaire sans couvercle

63 x 55 x 72 cm - 120 L



RC-2005-GRN

Conteneur alimentaire sans couvercle

63 x 55 x 72 cm - 120 L



RC-2005-GRY

Conteneur alimentaire sans couvercle

63 x 55 x 72 cm - 120 L



RC-2003-RED

Conteneur alimentaire sans couvercle

56 x 49 x 63 cm - 85 L



RC-2003-WHT

Conteneur alimentaire sans couvercle

56 x 49 x 63 cm - 85 L



RC-2003-YEL

Conteneur alimentaire sans couvercle

56 x 49 x 63 cm - 85 L



RC-2005-RED

Conteneur alimentaire sans couvercle

63 x 55 x 72 cm - 120 L



RC-2005-WHT

Conteneur alimentaire sans couvercle

63 x 55 x 72 cm - 120 L



RC-2005-YEL

Conteneur alimentaire sans couvercle

63 x 55 x 72 cm - 120 L



Tous les articles en **gras** sont des produits de stock habituel. Consulter les couleurs disponibles.

■ Conteneurs ronds agréés pour le contact (suite) 



RC-2013-BLA

Couvercle pour collecteur RC-2003

53 x 50 x 7 cm



RC-2013-GRN

Couvercle pour collecteur RC-2003

53 x 50 x 7 cm



RC-2013-GRY

Couvercle pour collecteur RC-2003

53 x 50 x 7 cm



RC-2013-RED

Couvercle pour collecteur RC-2003

53 x 50 x 7 cm



RC-2015-BLA

Couvercle pour collecteur RC-2005

61 x 57 x 7 cm



RC-2015-GRN

Couvercle pour collecteur RC-2005

61 x 57 x 7 cm



RC-2015-GRY

Couvercle pour collecteur RC-2005

61 x 57 x 7 cm



RC-2015-RED

Couvercle pour collecteur RC-2005

61 x 57 x 7 cm



RC-2013-WHT

Couvercle pour collecteur RC-2003

53 x 50 x 7 cm



RC-2013-YEL

Couvercle pour collecteur RC-2003

53 x 50 x 7 cm



RC-2092-BLA

Chariot ajustable pour RC-2003 et RC-2005

45 cm de Ø x 22 cm haut.



RC-2015-WHT

Couvercle pour collecteur RC-2005

61 x 57 x 7 cm



RC-2015-YEL

Couvercle pour collecteur RC-2005

61 x 57 x 7 cm



Rejoignez-nous



@DbmarkTweet



@dbmarkhosteleria



@dbmark_inst

Tous les prix sont indiqués en P.V.P. unitaire.

■ Collecteurs de tri

Solution parfaite pour l'élimination et le tri des déchets, conçus pour s'adapter aux espaces restreints. Vous pouvez choisir entre deux tailles de collecteurs (empilables) et différentes variétés de couvercles : carton, verre, emballages en plastique, boîtes, etc. Fabriqués en polypropylène.

PB-1080

Collecteur de tri sans couvercle

32 x 46 x 58 cm - 60 L



○ WHT ● GRY ● GRN
● BLU ● BLA



PB-1090

Collecteur de tri sans couvercle

32 x 46 x 76,2 cm - 80 L



○ WHT ● GRY ● GRN
● BLU ● BLA



PB-1011-GRY

Couvercle plat pour PB-1080-GRY et PB-1090-GRY

45,5 x 33 x 6,5 cm



PB-1012-GRN

Couvercle plat orifice rond pour PB-1080-GRY et PB-1090-GRY

45,5 x 33 x 6,5 cm

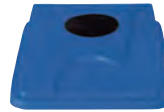

PB-1012-BLU

Couvercle plat orifice rond pour PB-1080-GRY et PB-1090-GRY

45,5 x 33 x 6,5 cm



PB-1013-YEL

Couvercle plat orifice carré pour PB-1080-GRY et PB-1090-GRY

45,5 x 33 x 6,5 cm



PB-1014-BLU

Couvercle plat pour carton et papier pour PB-1080-GRY et PB-1090-GRY

45,5 x 33 x 6,5 cm



PB-1014-YEL

Couvercle plat pour carton et papier pour PB-1080-GRY et PB-1090-GRY

45,5 x 33 x 6,5 cm



Paier/carton



Verre



Plastique



Alimentaire



Métal



Autres

*6 étiquettes de recyclage
incluent avec chaque
couvercle*

Tous les articles en **gras** sont des produits de stock habituel. Consulter les couleurs disponibles.

■ Collecteur de tri translucide

Facilement adaptable aux espaces restreints. Deux capacités disponibles : 60 y 80 L.



PB-1080-CLR

Collecteur de tri sans couvercle
32 x 46 x 58 cm - 60 L



PB-1090-CLR

Collecteur de tri sans couvercle
32 x 46 x 76,2 cm - 80 L



PB-1002-BLA

Chariot pour PB-1080
et PB-1090

48 x 33 x 14,5 cm



PB-1081-GRY-LID

Couvercle PUSH pour PB-1080
et PB-1090

34 x 47 x 22 cm



PB-1082-GRY-LID

Couvercle à cannettes pour
PB-1080-GRY et PB-1090-GRY

34 x 47 x 22 cm



PB-1083-GRY-LID

Couvercle à carton pour
PB-1080-GRY et PB-1090-GRY

34 x 47 x 22 cm



■ Couvertres Mix & Match pour collecteurs de tri

Pour créer le couvercle de votre choix, choisissez une couleur et combinez-la avec l'insert le plus approprié au type de déchet dont vous voulez vous débarrasser. Chaque couvercle est livré avec 6 autocollants : papier/carton, verre, plastique, alimentaire, métal ou autres.



PB-1030

Cadre Mix & Match
pour PB-1080
et PB-1090

45,5 x 32,5 x 2 cm



PB-1031-GRY

Insert Mix & Match
à ouverture carrée
pour PB-1030

28,3 x 23 x 1,8 cm



PB-1032-GRY

Insert Mix & Match
à ouverture ronde
pour PB-1030

28,3 x 23 x 1,7 cm



PB-1033-GRY

Insert Mix & Match
à ouverture fente
pour PB-1030

28,3 x 23 x 1,7 cm



PB-1034-GRY

Insert Mix & Match
à ouverture à clapets
pour PB-1030

28,3 x 23 x 3,8 cm



Tous les prix sont indiqués en P.V.P. unitaire.



Nettoyage

Ces panneaux sont très pratiques pour attirer l'attention des passants sur les risques d'accident lors des opérations de nettoyage ou d'entretien. Message d'avertissement imprimé sur les deux faces.



FS-1001-YEL

Panneau avec symbole "ATTENTION"

28 x 4 x 60 cm

 10



FS-1011-YEL

Panneau avec symbole "SOL HUMIDE"

28 x 4 x 60 cm

 10



FS-1012-YEL

Panneau avec symbole "NE PAS FRANCHIR"

28 x 4 x 60 cm

 10



FS-1013-YEL

Panneau avec symbole "DANGER-ÉLECTRICITÉ VOLTAJE"

28 x 4 x 60 cm

 10



FS-1014-YEL

Panneau avec symbole "TRAVAUX EN COURS"

28 x 4 x 60 cm

 10



FS-1015-YEL

Panneau avec symbole "ENTRÉE INTERDITE"

28 x 4 x 60 cm

 10



FS-1016-YEL

Panneau avec symbole "DANGER"

28 x 4 x 60 cm

 10



Pliable afin de réduire l'encombrement lors du stockage et du transport

Tous les articles en **gras** sont des produits de stock habituel. Consulter les couleurs disponibles.



Grande variété de pièces de rechange des articles les plus utilisés en hôtellerie et restauration.

UPC400

1318MTC | UPC300

UPCS's



Code	Dimensions	UE
Porte / Couvercle ⁽¹⁾		
7335	Pour UPC400	1
6318	Pour 300MPC, 1318MTC	1
7615	Pour UPCS140, UPCS160, UPCS180	1
Joints		
12119	52 x 69 x 137,2 cm	1
12102	52 x 69 x 137,2 cm - uniquement pour porte sup. chaude	1
Fermetures ⁽²⁾		
60135	Pour UPC400	1
H05021	Pour 300MPC, 1318MTC	1
60423	Pour UPCS140, UPCS160, UPCS180	1
60212	Kit de fermeture en nylon noir	1
Bouchon d'aération		
H07001	Pour conteneurs postérieurs à 2007 (bouchon noir)	1
14200	Pour conteneurs antérieurs à 2007 (bouchon blanc)	1
Tige		
42132	Pour UPC400	1
42136	Pour UPC800, UPC1600	1
42133	Clip pour tige	1

⁽¹⁾ Indique la couleur de la porte ou du couvercle

⁽²⁾ Si vos fermetures sont métalliques ou votre matériel a été acheté avant 2003 contactez-nous

Tous les prix sont indiqués en P.V.P. unitaire.

B

CONTENEURS POUR BOISSONS

LCD's

UC's

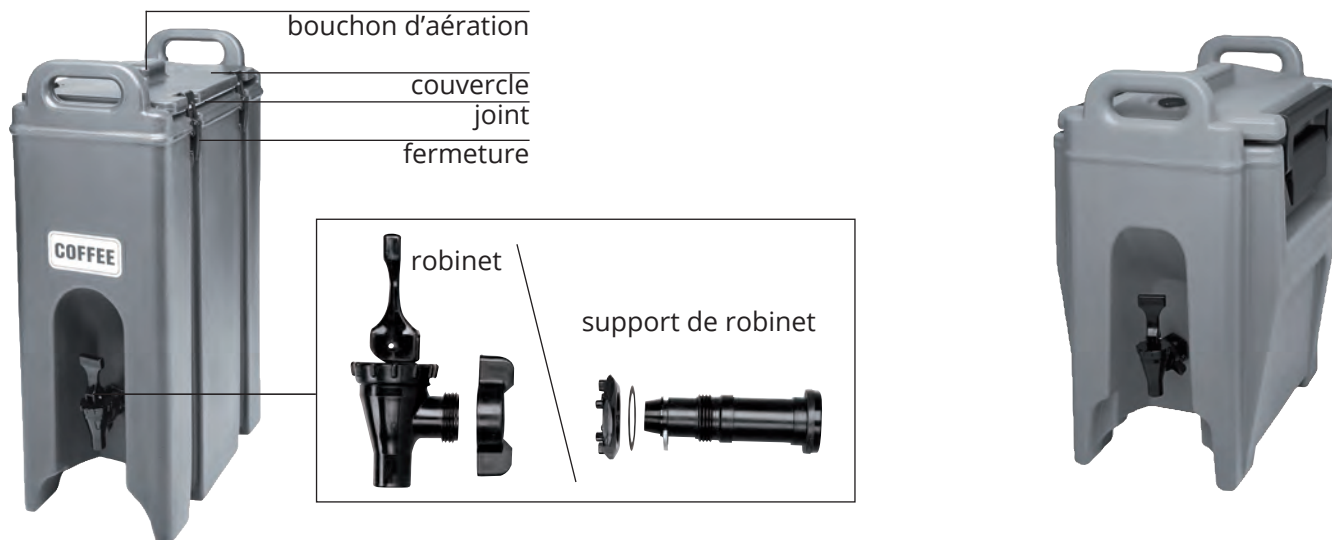

Code	Dimensions	UE
Couvercles ⁽¹⁾		
6316	Pour 100LCD	1
6322	Pour 250LCD, 350LCD, 500LCD	1
6323	Pour 1000LCD	1
7354	Pour UC250, UC500	1
7356	Pour UC1000	1
Joints		
12100	Pour 100LCD	1
12101	Pour 250LCD, 350LCD, 500LCD	1
12106	Pour 1000LCD	1
12117	Pour UC250, UC500	1
12130	Pour UC1000	1
Fermetures ⁽²⁾		
60264	Pour 100LCD, 1000LCD	1
60263	Pour 250LCD, 350LCD, 500LCD	1
60135	Pour UC250, UC500, UC1000	1
Bouchon d'aération		
H07001	Pour conteneurs postérieurs à 2007 (bouchon noir)	1
14200	Pour conteneurs antérieurs à 2007 (bouchon blanc)	1
Robinets		
60267	Robinet	1
64003	Support de Robinet	1

⁽¹⁾ Indique la couleur du couvercle

⁽²⁾ Si vos fermetures sont métalliques ou votre matériel a été acheté avant 2002 contactez-nous.

Tous les articles en **gras** sont des produits de stock habituel. Consulter les couleurs disponibles.

IB's



IBS's



CC32



Code	Dimensions	UE
Couvercles		
IB27LIDCW	Pour IB27	1
IB32LIDCW	Pour IB32, CC32	1
IB36LIDCW	Pour IB36	1
IB44LIDCW	Pour IB44	1
60432	Couvercle avant pour IBS20	1
60433	Couvercle arrière pour IBS20	1
60271	Couvercle avant pour IBS27	1
60270	Couvercle arrière pour IBS27	1
60273	Couvercle avant pour IBS37	1
60272	Couvercle arrière pour IBS37	1
Roues		
60431	Roue pivotante pour IBS20, IBS27	1
60005	Roue pivotante pour IBS37, IB27, IB32, IB36, IB44, CC32	1
60430	Roue fixe pour IBS20, IBS27	1
60009	Roue fixe pour IBS37, IB27, IB32, IB36, IB44, CC32	1
Robinets		
H19007	Pour CC32	1

NOTA: Si su equipo fue comprado antes del año 2005 consúltenos.

Tous les prix sont indiqués en P.V.P. unitaire.

Carro de platos



BC331KD



CDR2020



Code	Dimensions	UE
Roues		
60007	5" avec frein pour DC575, DC700, DC825, DC1225	1
60008	5" sans frein pour DC575, DC700, DC825, DC1225	1
41020	10" pour DC575, DC700, DC825, DC1225	1
H06002	10" pour ADCS, DCS950, DCS1125	1
H06001	5" avec frein pour ADCS, DCS950, DCS1125	1
41064	Pour CDR2020	1
41063	Pour BC331KD	1
41076	Pour BC340KD	1
Essieux		
60082	Pour DC1225	1
60083	Pour DC575, DC700, DC825	1
H06014	Pou ADCS	1
Housses		
14300	Pour DC825	1
14310	Pour DC575, DC700	1
14311	Pour DC1225, DCS950, DCS1125	1
ADCC	Pour ADCS	1
Anses		
41079	Pour BC340KD (anse noire)	1
41080	Pour BC340KD (anse grise)	1
41065	Pour BC331KD (anse grise)	1
41066	Pour BC331KD (anse noire)	1

Tous les articles en **gras** sont des produits de stock habituel. Consulter les couleurs disponibles.



CODE	PAGE	CODE	PAGE	CODE	PAGE	CODE	PAGE	CODE	PAGE
00082-1-SAN-CL	111	1014VSNH	101	10776	45	1206	193	123517BR	24
00083-1-SAN-CL	111	1015	156	10777	45	120VS	101	123518BR	24
00084-1-SAN-CL	111	10154	89	1084	63	120VSNH	101	123519BR	24
00085-1-SAN-CL	111	10155	89	10853C-12	248	12100	369	123569	263
00086-1-SAN-CL	111	10156	89	10853K-12	248	12101	369	123570	263
1000	156	10157	89	10853M-12	248	12102	368	1240	275
10006	197	10158	89	1086	63	12106	369	12463C-12	249
10007	197	10159	89	10CV1CH	236	1210PW	318	12463C3	249
1000LCD	311	1015MT	177	10CV1D	236	12117	369	12463C3F	249
1001301	118	10160	89	10HC258	345	12119	368	12463CF	249
1001401	118	10161	89	10HC414	345	12130	369	124VS	101
1001402	118	10163	89	10HE1	346	1216	156	124VSNH	101
10016	25	10164	89	10HE2	346	1216CL	160	1252SLINB250	242
10017	25	1021	259	10HPC	281	1216CT	161	12CV1	236
10018	25	102	197	10HPCH	281	1216D	160	12HP	281
10019	25	1022	259	10HPCHN	281	1216DC	159	12HPH-150	286
10020	87	1023	259	10HPD	281	1216DCET	159	12HPH	281
10021	87	1024	259	10HS1114	341	1216ET	165	12PP	234
10022	87	10253	24	10HS318	341	1216FF	174	12RS12	205
10023	87	10254	24	10HS434	341	1217FFH	174	12SFSCW	231
10030	51	10255	24	10HS638	341	12183CW	233	12SFSCW 441	232
10031	51	10262	71	10HS800	341	12183P	233	12SFSP	231
10034	131	10277BK	127	10HS958	341	12186CW	233	12SFSP	231
10035	131	10278BK	127	10PPCH	234	12186P	233	12SR	68
10036	131	10279BK	127	10PPCWSC	234	12189CW	233	12SV	251
10037	131	10289	54	10PPD	234	12189P	233	1300	156
10038	131	10290	54	1100	156	1218BK	203	1306	147
10039	131	10291	54	1100CT	161	1218CCW	233	1313	156
10040	132	10292	54	1102	250	1218CP	233	1318	156
10041	132	10302MT	177	1113W	62	1218DSCW	233	1318CC	316
10042	132	10303	54	1116	156	1218MT	177	1318MT	177
10043	132	10304	54	1117W	62	1218SCCW	233	131B	350
10047	164	1030MT	177	1118W	62	1219D	160	137510	63
10048	164	103	197	1120CBP	333	1220D	160	13759	63
1006AS	98	1032J	253	1120CBR	333	1222D	160	13CLRHP	281
10076	41	10360	71	112 430 000	179	122 400 021	178	1400	156
10077	41	103VS	101	11253C-12	248	122 400 050	179	1400CT	161
10078	41	103VSNH	101	11253K-12	248	1224	194	1400ET	165
10079	41	10413	79	11253M-12	248	122 450 050	179	14105CP	176
10080	41	10414	79	1128J	253	1224MT	177	14105CW	175
10081	41	10415	79	1135W	61	122 500 050	179	1411CP	176
10090	71	10416	79	1155	148	1225	201	1411CW	175
100LCD	311	10486	132	1156	148	122 600 021	178	1418	156
100MCCW-135	257	10487	132	1157	148	122 600 050	179	14187TRCW	175
100MCCW-441	257	10488	132	11663C-12	248	1226	201	1418CL	160
100MPC	314	10496	79	11663C3	249	122 650 050	179	1418CT	161
100MPCHL	314	10515	79	11663C3F	249	122 700 014	178	1418CW	177
100VS	101	10516	127	11663CF	249	122 700 050	179	1418CWH	177
100VSNH	101	105	203	11663K-12	248	1228	201	1418D	160
1010VS	101	105VS	101	11663M-12	248	1230MT	177	1418DC	159
1010VSNH	101	105VSNH	101	1169W	61	123460	79	1418DCET	159
101	196	10626	72	116VS	101	123464	97	1418ET	165
1012VS	101	1064J	253	116VSNH	101	123465	97	1418FF	174
1012VSNH	101	10699	70	1172W	61	123466	97	1418TR	157
1014	156	106VS	101	1175W	61	123468	15	1418TRCW	177
10145CW	175	106VSNH	101	1177W	61	123469	15	14200	368, 369
10146CW	175	1071	63	1188W	61	123471	67	1422TR	157
10146DCP	176	107	203	1189W	61	123472	67	14300	371
10146DCPC	176	1073	63	1192W	61	123473	67	14310	371
10146DCW	175	1074	63	1200	156	123475	67	14311	371
10146DCWC	176	1075	63	1200DIV	317	123476	67	1472	61
1014CL	160	10758	72	1200P-	107	123494	70	1475	61
1014CT	161	10762	178	1202	193	123495	70	14CV1	236
1014ET	165	10763	178	1203	193	123496	70	14HP	281
1014FF	174	1076	63	1204	193	123497	72	14PP	234
1014VS	101	1077	63	1205	193	12351506	24	1500	270

CODE	PAGE	CODE	PAGE	CODE	PAGE	CODE	PAGE	CODE	PAGE
150S&P-2	143	165434	340	182SS20	293	20GE2	346	23CLRHP	283
1510	270	165534	340	182SS40	293	20GE4	346	23SLINB250	242
1511A	206	165638	340	182SS60	293	20GE5	346	240002	99
1511C	206	165738	340	1831/1	294	20HPC	283	240003	99
1511SC	206	165800	340	1832/1	294	20HPCH	283	240004	99
1514	270	165900	340	18351/1	294	20HPCHN	283	240005	99
1516	270	165958	340	18352/1	294	20HPD	283	240006	99
1520	156	165V	251	1862	271	20HPL	283	240007	99
1520CBCP	334	1722CBCP	334	1863	271	20HPLN	283	240008	99
1520CBP	333	1722CBP	333	1864	271	20LPHPC	282	240009	99
1520CBPF	333	1722CBR	333	1865	271	20LPHPD	282	240010	122
1520CBR	333	17HE1	346	1866	271	20PPCH	234	2409	271
1520CL	160	17HE2	346	1867	271	20PPCWSC	234	24	162
1520CT	161	17HS1114	341	18CV1	236	20PPD	234	242	267
1520CW	177	17HS318	341	18PP	234	20S1058	340	242BKEU	268
1520CWH	177	17HS434	341	18SFSCW	231	20S1114	340	242W	267
1520D	160	17HS638	341	18SFSCW 441	232	20S1214	340	2436UTH	336
1520DC	159	17HS800	341	18SFSP	231	20S318	340	2436UTHS	336
1520DCET	159	17HS958	341	18SFSP	231	20S418	340	2472	61
1520ET	165	1800CT	161	1908	147	20S434	340	2488	61
1520TR	157	1802	196	1912	147	20S534	340	2489	61
1524B	333	1810	196	1950	157	20S638	340	24BK	162
154S&P-2	143	1821/1-20	293	1950CT	161	20S738	340	24CV1	237
1550	157	1821/1-40	293	20000	99	20S800	340	24HP	283
1550CT	161	1821/1-65	293	20001	99	20S900	340	24LPHP	282
155S&P-2	143	182612CW	233	20002	99	20S958	340	24PP	234
157510	64	182612P	233	20003	98	21000	49	24SV	251
157512	64	1826	156	20004	98	21001	49	2500	157
15759	64	182615CW	233	20005	98	21002	49	2500CT	162
159	280	182615P	233	20006	98	21003	49	2504	146
1596CP	176	18263CW	233	20007	98	21004	49	2508	146
1596CW	175	18263P	233	20008	98	21005	49	250LCD	311
15CLRHP	281	18266CW	233	20009	98	21006	49	2510	270
1600	156	18266P	233	2000P-	107	21007	49	2512	146
1600CT	161	18268CLRWC	233	20025BK	96	21155CBP	333	2514	270
1600DIV	317	18269CW	233	20025W	96	21155CBR	333	2516	270
1600ET	165	18269P	233	20026BK	96	21157CBP	333	251BKEU	268
1600P-	107	1826CCW	233	20026W	96	21157CBR	333	251W	267
1600TL	161	1826CL	160	20027BK	96	2115CBCP	334	253BKEU	268
1603	197	1826CLRWC	233	20027W	96	2115CBCR	334	253W	267
1604	197	1826CP	233	20028BK	96	21	162	254	267
1605	197	1826CT	161	20028W	96	2116	265	25CLRHP	283
1606	197	1826DSCW	233	20029BK	96	2120	265	25E1	346
161716	62	1826LBC	325	20029W	96	2124	265	25E2	346
1621CBP	333	1826LBCSP	325	20030W	97	2130	265	25E4	346
1622	156	1826LTC	325	20031W	97	2206-1-	108	25E5	346
16225	156	1826LTC3	325	2003	267	2209-1-	108	25MCCW-135	257
1622CT	161	1826LTCSP	325	20032W	97	2211-1-	108	25MCCW-441	257
165PW	179	1826MT	177	2009	56	2212-1-	108	25S1058	340
1689	62	1826MTC	325	200MCCW-135	257	2216-1-	108	25S1114	340
1692	62	1826SCCW	233	200MCCW-441	257	22	162	25S1214	340
16C258	345	182C1/1	294	200MCH	287	2220-1-	108	25S318	340
16C414	345	182C100	293	2012	56	2221-1-CL	108	25S418	340
16C578	345	182C20	293	2016	56	2224-1-	108	25S434	340
16CV1	236	182C65	293	2025	156	2232-1-	108	25S534	340
16E1	346	182F1/1	293	2025MT	177	22CV1	237	25S638	340
16E2	346	182G1/1	294	2030UT	336	22HP	283	25S738	340
16E4	346	182G2/1	294	2068	264	22LPHP	282	25S800	340
16E5	346	182G2/3	294	207-5-W	15, 80	22PP	234	25S900	340
16HP	281	182MF1/1	293	20C258	345	22SFSCW	231	25S958	340
16PP	234	182MFB	293	20C414	345	22SFSCW 441	232	2632	156
16S1058	340	182MFBS	293	20CFC	32	22SFSP	231	263B-1	350
16S1114	340	182MFS1/1	293	20CV1CH	237	22SFSP	231	2675	271
16S1214	340	182S1/1-20	294	20CV1D	237	23	162	2677	271
16S318	340	182S1/1-40	294	20E2	346	237	201	26CF	32
16S418	340	182S1/1-65	294	20GE1	346	23BK	162	26CV1	237

CODE	PAGE	CODE	PAGE	CODE	PAGE	CODE	PAGE	CODE	PAGE
26HP	283	32HP1H-150	286	39104	55	4-T2000	136	428	272
26PP	234	32HP	284	39105	55	4-T250	136	42CV1	237
2700	157	32HP2H-150	286	395	201	4-T3000	136	42HP	284
2700CT	162	32PP	234	396	201	4-T3020	136	42PP	235
2712	56	330-S	195	4-22770	134	4-T3050	136	43017	208
2716	56	330	195	4-22778	134	4-T4000	136	43017BP	208
2774	56	3306	271	4-22780	134	4-T6000	136	43017G	208
282SS20	293	3343	156	4-22782	134	4-TD1900	137	43	272
282SS40	293	33CLRHP	284	4-22787-S	134	4-TE1050	137	44017CML	208
282SS60	293	345	195	4-22788-M	134	4-TF1600	137	44017DB	208
28CV1	237	348	259	4-22789-L	134	4-TG1080	137	44017SC	208
28PP	234	34CV1	237	4-33778	134	4-TH1700	137	4403	200
2900CT	162	34HP	284	4-33780	134	4-TI1808	137	4404	200
295	196	34PP	234	4-33782	134	4-TL1215	137	4405	200
295X	196	350LCD	311	4-33888	124	4-TN1000	137	44060	272
2SFSCW	231	35BK	195	4-35809	66	4-TN250	137	4407	200
2SFSCW 441	232	35BL	195	4-35814	66	4-TS1010	137	44080	272
2SFSP	231	35CLRHP	284	4-35999	66	4-TS4010	137	4424	271
2SFSP	231	35G	195	4-80007	135	4-TVariety	137	44CV1	237
300	118	35R	195	4-80008	135	4-TY1200	137	44HP	284
3004	275	35W	195	4-80117	135	4007BK	56	44PP	235
3005	275	36CF	32	4-80118	135	4009BK	56	451	267
300DIV	317	36CV1	237	4-80300	135	400DIV	317	46	156
3016	275	36E1	346	4-80555	124	400MCCW-135	257	461BKEU	268
3033	275	36E2	346	4-80800	128	400MCCW-441	257	461W	267
3046	156	36E4	346	4-80808	128	400MCH	287	46CV1	237
30CFC	32	36E5	346	4-80810	128	400STP	318, 337	46HP	284
30CV1CH	237	36HP	284	4-80818	128	4012BK	56	46PP	235
30CV1D	237	36PP	234	4-80822	128	4016BK	56	4701	55
30GE1	346	36S1058	340	4-80824	128	40	272	4702	55
30GE2	346	36S1114	340	4-80910	124	40CV1CH	237	4703	55
30HPC	284	36S1214	340	4-80999	124	40CV1D	237	4704	55
30HPCH	284	36S318	340	4-81823	125	40HPC	284	4706	55
30HPCHN	284	36S418	340	4-81828	125	40HPCH	284	4708	55
30HPD-150	286	36S434	340	4-81833	125	40HPCHN	284	4712	55
30HPD	284	36S534	340	4-81855	125	40HPD	284	49B53	294
30HPL	284	36S638	340	4-81856	125	40PPCH	235	49B60	294
30HPLN	284	36S738	340	4-81858	125	40PPCWSC	235	49E1	346
30PPCH	234	36S800	340	4-81859	125	40PPD	235	49E2	346
30PPCHN	234	36S900	340	4-81860	124	4100BKEU	268	49S1114	341
30PPCWSC	234	36S958	340	4-818610	124	4100PBKEU	268	49S318	341
30PPD	234	3712BKEU	260	4-81865	124	4100S	267	49S434	341
30S&P	143	3712BLEU	260	4-81868	124	41020	371	49S638	341
30S1114	340	3712GEU	260	4-81870	134	4103W	267	49S800	341
30S318	340	3712REU	260	4-81872	134	4104BKEU	268	49S958	341
30S434	340	3712YEU	260	4-81873	134	41063	371	4CHS	145
30S638	340	3715	264	4-81874	134	41064	371	4CHSBK	145
30S800	340	3716BKEU	260	4-81878	134	41065	371	4FBRTT	183
30S958	340	3716BLEU	260	4-81929	135	41066	371	4SFSCW	231
314	142	3716GEU	260	4-81999	135	4106W	276	4SFSCW 441	232
31763C	249	3716REU	260	4-82010	135	41076	371	4SFSP	231
3177GCS	74	3716YEU	260	4-82018	135	41079	371	4SFSP	231
3177GCS	74	3753	156	4-835809	66	41080	371	500LCD	311
320A	195	376	194	4-835814	66	41	272	500P-	107
320C	195	377	194	4-83599	66	415CBP	333	501K	200
3242	156	3774BKEU	260	4-83888	124	4206	269	5063	121
3253	156	3774BLEU	260	4-84100	121	4208	269	5064	121
3253CL	160	3774GEU	260	4-84105	121	4210	269	5066	121
3253CT	162	3774REU	260	4-84111	121	4212	269	5067	122
32563C	249	3774YEU	260	4-882808	135	42132	368	5068	122
3263C	249	3853	156	4-89444	121	42133	368	5071	122
3263C3	249	38CV1	237	4-89448	121	42136	368	5072	122
3263K	249	39100	55	4-92065-B	135	4214	269	5073	122
3263M	249	39101	55	4-T1000	136	42	272	50MCCW-135	257
32C	253	39102	55	4-T1020	136	4244A	195	50MCCW-441	257
32CV1	237	39103	55	4-T1050	136	426	272	512	199

CODE	PAGE	CODE	PAGE	CODE	PAGE	CODE	PAGE	CODE	PAGE
5122	196	60271	370	6708	264	853FH	175	94	259
5132	196	60272	370	671	195	85	69	94CV1	238
5140A	207	60273	370	68VS	101	85SFVS	101	94HP	285
5140C	207	60423	368	68VSNH	101	85SFVSNH	101	94PP	235
5140CBL	207	60430	370	6F	29	86VS	101	950P-	107
5140F	207	60431	370	6FBRTT	183	86VSNH	101	95	204
5140R	207	60432	370	6RS6	205	87	259	95VS	101
5142	196	60433	370	6SFSCW	231	8F	29	95VSNH	101
5151A	206	605	199	6SFSCW 441	232	8FB434	345	96	259
5151C	206	60CFC	32	6SFSP	231	8FBNH434	345	96SKRC-135	279
5188	202	60CV1CH	238	6SFSP	231	8HC258	345	96SKRD-135	279
5198	202	60CV1D	238	705	261	8HE1	346	96SKRLC-405	280
5222	196	60HPC	285	707B	350	8HE2	346	96SKRLD-406	280
5242	196	60HPCH	285	708	261	8HS1114	341	96SKRLM-408	280
5	261	60HPCHN	285	712	56	8HS318	341	96SKRLP-148	280
526T	200	60HPD	285	713	261	8HS434	341	96SKRM-135	279
5288	202	60HPL	285	716	56	8HS638	341	96SKRP-135	279
532T	200	60HPLN	285	722	269	8HS800	341	978SFVS	101
5388	202	60PPCH	235	724	269	8HS958	341	978SFVSNH	101
5398	202	60PPCHN	235	724A	269	8RS8	205	98	259
53FCAPBK	252	60PPCWSC	235	725	269	8SFSCW	231	985	272
53FCAPBL	251	60PPD	235	730SR	190	8SFSCW 441	232	986	272
53FCAPLBL	252	612	199	730WS	190	8SFSP	231	9907-1-	108
53FCAPLGN	252	624	199	7319	271	8SFSP	231	9909-1-	108
53FCAPPR	251	62CV1	238	7324	271	900	156	9910-1-	108
53FCAPY	252	62HP	285	7335	368	900CT	161	9912-1-	108
5412CBP	205	62PP	235	7354	369	900P-	107	9914-1-	109
5488	204	6302MT	177	7356	369	906	141	9916-1-	109
5488W	204	630MT	177	7412	271	908	141	9920-1-	109
5512	261	6316	369	7418	271	9085	143	9921-1-CL	109
5518	261	6318	368	74	56	90CV1C	238	9922-1-	109
5524	261	6322	369	753BK	203	90CV1D	238	99	259
5536	261	6323	369	75	69	90HPC	285	9932-1-	109
5548	261	638	199	7615	368	90HPD	285	9955-1-	108
5560	261	63CLRHP	285	76	194	90PPC	235	99VS	101
557TCH	93	63EU	149	7704	264	90PPCWSC	235	99VSNH	101
56B	148	63TC3	249	77	194	90PPD	235	9E1	346
56C	148	64003	369	797	146	910	141	9E2	346
56W	148	6404AG	207	800P-	107	9113CP	176	9RS9	205
57	156	6404CI	207	8032A	193	9113CW	175	9S1114	340
5833	203	6404G	207	8032GN	193	9114CP	176	9S318	340
5834	203	6404R	207	8032R	193	9114CW	175	9S434	340
596	145	64CV1	238	8032W	193	911CPC	176	9S638	340
598P	195	64HP	285	8032X	193	911CWC	176	9S800	340
599P	143	64PP	235	8032Y	193	911VS	101	9S958	340
5CHBAM	145	650WS	190	8064A	193	911VSNH	101	A11	8
5CHBAMCP	145	65CLRHP	285	810	156	912CBP	333	A1613	8
5FBRTT	183	65EU	149	8128A	193	913A	98	AB14	8
60005	370	662	253	822	262	913AS	98	AC57	123
60007	371	662K	253	823	262	913MT	177	AC59	123
60008	371	663	253	824	262	913VS	101	AC885H	123
60009	370	663K	253	825	262	913VSNH	101	AC885R	123
600	143	664	253	826	262	915	156	AC885S	123
6005	207	664K	253	8262MT	177	915CP	176	ACABB1409	39
60082	371	667	203	826MT	177	915CW	175	ACABB1610	39
60083	371	66CF	32	827	262	916	143	ACAMBB1206	40
600N	143	66CV1	238	828	262	918MT	177	ACAMBB1507	40
60135	368, 369	66EU	149	830	262	91VS	101	ACAMR10	40
6017	207	66HP	285	8302MT	177	91VSNH	101	ACAMR14	40
6020-BK	92	66PP	235	830MT	177	926	156	ACAMR1606	40
60212	368	670	195	839	94	92615MT	177	ACAMR2007	40
6026-RB	95	6702	264	83S&P	143	926MT	177	ACAPB2006	39
60263	369	6703	264	840	94	92CV1	238	ACAPB2208	39
60264	369	6704	264	84	259	92HP	285	ACAR1208	38
60267	369	6705	264	843	94	92PP	235	ACAR1409	38
60270	370	6706	264	848	94	937	126	ACAR1812	38

CODE	PAGE	CODE	PAGE	CODE	PAGE	CODE	PAGE	CODE	PAGE
ACARD0909	38	B-2412-DW	76	BAMP7	139	BDGR1	72	C100TPR	250
ACARD1212	38	B-247-BK	92	BAMPS45	142	BDGR2	72	CA1300-E01	170
ACARD14	40	B-30-	84	BAMPS6	142	BDGTUB	72	CA1300	170
ACARD16	40	B-32-MN-W	90	BAMSP145	142	BF-080-W	78	CA1623	170
ACAV1608	38	B-42-	86, 88	BAMSP245	142	BF-10-BK	91	CA2026	170
ACAV2008	38	B-45-DW	77	BAMSP345	142	BF-6-BK	91	CA2028	170
ACR259	123	B-454-DW	77	BAMSP545	142	BF-7-BK	91	CA2129	170
ACR57	123	B-47-F	94	BAMSP645	142	BF-9-BK	91	CA2632	170
ACR59	123	B-48-DW	77	BAR540	190	BFCH4	145	CA2738	170
ADC33	339	B-49-DW	77	BAR540DS	190	BH377	194	CA2836	170
ADCC	371	B-50-	84	BAR545R	190	BK11709	65	CA3200	170
ADCS	339	B-525-DW	77	BAR650	190	BK155	65, 148	CA3244	170
ADCS	339	B-549-BK	92	BAR650CP	190	BK157	123	CA3247TR	170
AGD2020	351	B-60-	84	BAR650DS	190	BK17209	65	CA3253	170
AM3712	260	B-720-BK	94	BAR650DSCP	190	BK17409	65	CA3343	170
AM3716	260	B-783-	17	BAR650SDSX	189	BK17410	65	CA3446	170
AM3774	260	B-784-	17	BAR650DSPMT2	189	BK17412	65	CA3646	170
ARL3	8	B-785-	17	BAR650DX	189	BK17508	65	CA3748	170
ASHR1410	39	B-786-	17	BAR650PMT220	189	BK17510	65	CA3753	170
ASHR1612	39	B-788-	17, 20	BAR730	189	BK1908	147	CA3800	170
ASHR1814	39	B-788-RSP	17	BAR730CP	189	BK1912	147	CA3952	170
AT-0202-DGRY	348	B-789-	17, 20	BAR730DS	189	BK1915	147	CA4064H	170
AT-0210-DGRY	348	B-789-RSP	17	BAR730DSCP	189	BK21709	64	CA4300	170
AT-0212-DGRY	348	B-790-	17, 20	BAR730SDSX	189	BK256	64, 148	CA4361	170
AT-0222-DGRY	348	B-790-RSP	17	BAR730DSPMT2	189	BK37109	66	CB1218BLA	277
AT-0232-DGRY	349	B-791-BK	16	BAR730DX	189	BK37409	66	CB1218BRA	277
AT-0252-DGRY	348	B-791-RSP	16	BAR730PMT220	189	BK37410	66	CB1218GNA	277
AT-0262-DGRY	349	B-791-W	16	BBQ3500	138	BK37508	66	CB1218RA	277
AT-0291-DGRY	348	B-792-	17, 20	BBQ48	126	BK60406	326	CB1218WA	277
AT-0292-DGRY	349	B-792-RSP	17	BBR181212	50	BK60407	326	CB1218YA	277
AT-0302-ALU	348	B-797-	20	BBR18126	50	BKB12	147	CB1220	188
AT-0303-ALU	348	B-797-W	16	BBR480	184	BKB8	147	CB1824BLA	277
AT-0325-ALU	349	B-798-	20	BBR720	184	BKP4	43	CB1824BRA	277
AT-0402-MSSTL	348	B-798-W	16	BC-170-DW	77	BKR4	43	CB1824GNA	277
AT-0422-MSSTL	349	B-8-	86, 88	BC-70-DW	77	BKT2	64	CB1824RA	277
AT-0990-DGRY	349	B-86-DW	77	BC1115SH	330	BKT2A	64	CB1824WA	277
AT-1271-DGRY	349	B-925-DW	77	BC11TC	330	BKT3	64	CB1824YA	277
AT-1271-SIL	349	BAD1500	69	BC225	330	BR-0025-CLR	352	CB912WA	277
AT-1272-DGRY	349	BAMBA35	141	BC22545	330	BR-0075-CLR	352	CBA183672V4	226
AT-1272-SIL	349	BAMBA45	141	BC230	330	BR1034CUB	345	CBA184272V4	226
AT-1273-DGRY	349	BAMCBCP	141	BC23045	330	BR258	343, 346	CBA184872V4	226
AT-1273-SIL	349	BAMDB3	138	BC235	330	BR414	343	CBA185472V4	226
AT-2030-BLA	354	BAMDB45	138	BC23545	330	BR578	343	CBA186072V4	226
AT-2030-MSSTL	354	BAMDB5	138	BC330	330	BR712	343	CBA213672V4	226
AT-2030-SIL	354	BAMDCB35	141	BC33045	330	BR918CUB	345	CBA214272V4	226
AT-2030-SSSTL	354	BAMDCN5	138	BC331KD	332	BSC0610	199	CBA214872V4	226
AW4	8	BAMDCN6	138	BC331KDSH	332	BSC1216	199	CBA215472V4	226
AW5	8	BAMDCN7	138	BC331KDTC	332	BSC2024	199	CBA216072V4	226
B-10-MN-W	90	BAMDCP1	138	BC340KD	332	BT1914	204	CBA243672V4	226
B-100-	84	BAMDCP2	138	BC340KDP	332	BT2013	9, 204	CBA244272V4	226
B-105-DW	77	BAMF35	139	BCD1400	203	BTB1610	204	CBA244872V4	226
B-110-	84	BAMH45	142	BCD6000	197	BTSPOON	200	CBA245472V4	226
B-12-MN-W	90	BAMH6	142	BCD6100	197	BUF48	183	CBA246072V4	226
B-123-F	94	BAMK35	139	BCD6105	198	BUF72	183	CBCC	225
B-124-F	94	BAMK45	139	BCD6105BK	198	BV6CW	144	CBDS18	225
B-125-F	94	BAMK7	139	BCD6107	198	BW-1025-PC-CL	117	CBDS21	225
B-127-DW	77	BAML35	139	BCD6107BK	198	BW-1050-PC-CL	117	CBDS24	225
B-129-F	94	BAML45	139	BCT1014	176	BW-1100-PC-CL	117	CBG1218ABL	278
B-139-DW	76	BAML45	142	BDCHBD	72	BW-1892-CL	117	CBG1218ABR	278
B-140-	84	BAMP35	139	BDG1000	70	C-1001-W	78	CBG1218AGN	278
B-16-MN-W	90	BAMP35A	140	BDG1000T	72	C-1002-W	78	CBG1218ARD	278
B-1611-DW	76	BAMP35G	140	BDG2000	70	C-1004-W	78	CBG1218AWH	278
B-167-DW	77	BAMP45	139	BDG2000T	72	C-107-W	78	CBG1218AYL	278
B-18-	86, 88	BAMP45A	140	BDG3000	70	C-108-W	78	CBG1520ABL	278
B-220-	84	BAMP45PR	140	BDG3000T	72	C100TA	250	CBG1520ABR	278
B-24-DW	77	BAMP5G	140	BDGINFCORE	72	C100TC	250	CBG1520AGN	278

CODE	PAGE	CODE	PAGE	CODE	PAGE	CODE	PAGE	CODE	PAGE
CBG1520ARD	278	CD1826MTCHB	337	CP-31334-6	342	CS-6105-W	81	CW30151	53
CBG1520AWH	278	CD1826PDB	228, 337	CP-32328-4	342	CS-6106-W	13, 81	CW30152	93, 246
CBG1520AYL	278	CD2020	335	CP-32328-5	342	CS-6107-W	13, 80	CW40161	73
CBG1824ABL	278	CD2020H	335	CP-32328-6	342	CS-6108-W	15, 80	CW40163	73
CBG1824ABR	278	CD2020HB	335	CP-32328-7	342	CS-6111-W	81	CW40165	73
CBG1824AGN	278	CD2028	335	CP1210	317	CS-6112-W	81	CW40167	73
CBG1824ARD	278	CD300	318, 326, 336	CP12	57	CS-6116-W	80	CW40175	73
CBG1824AWH	278	CD300H	337	CP15	57	CS-6119-W	80	CW40176	74
CBG1824AYL	278	CD300HB	337	CP2632	299	CS-6352-CN-W	85	CW40177	74
CBID6	225	CD3253EPP	299, 336	CP27	57	CS-7-	86, 88	CW4100N	27
CBPK1872	225	CD400	318, 336	CP3253	188, 299, 317	CS-70-	83	CW4140N	27
CBPK2172	225	CD4060EPP	299, 336	CP6040	326	CS-800-	84	CW7002BK CW7002R26	
CBPK2472	225	CDC300	299, 336	CPH3	186	CS-9-	86, 88	CW7004BK CW7004R26	
CBR6	279	CDC400	299, 336	CPL12	57	CS-90-	83	CW7010BK CW7010R26	
CBR6BK	279	CDR2020	335	CPL27	57	CS-900-	84	CWA12	294
CBSK1836V1	225	CDR2020H	335	CPMU244867FXPKG	221	CSDBA	214, 221	CWA20	294
CBSK1842V1	225	CECBL	341	CPMU244867SUPKG	216	CSDBS	214	CWDC1030	27
CBSK1848V1	225	CFPFRC10	32	CPRMUG-01	116	CSDDC	215	CWDC1040	27
CBSK1854V1	225	CFPMRC10	32	CPRMUG-02	116	CSDR7	215	CWDC1050	27
CBSK1860V1	225	CFPSRC10	32	CPU244864SUPKG	216	CSDR8	215	CWDC1070	27
CBSK2136V1	225	CFR18	32	CR12	334	CSEQ3	214, 225	D12-	104
CBSK2142V1	225	CFRC18	32	CR3	43	CSHDTK10	222	D14-	104
CBSK2148V1	225	CFRSC18	32	CRATE11	44	CSHDTK12	222	D16-	104
CBSK2154V1	225	CGH100WEU	301	CRATE114	44	CSHDTK145	222	D24-	104
CBSK2160V1	225	CGH1W12VCAR	301	CRATE114BK	46	CSID6	214, 221	D8-	104
CBSK2436V1	225	CGH200WEU	301	CRATE116	44	CSR3	310	DB18263CW	228
CBSK2442V1	225	CH2	145	CRATE116BK	46	CSR5	310	DB18263P	228
CBSK2448V1	225	CH5	145	CRATE11BK	46	CSSC244818	216	DB18266CW	228
CBSK2454V1	225	CHOPSTICKS	95	CRATE11W	45	CSSD248	214	DB60407	228
CBSK2460V1	225	CHX4	145	CRATE12	44	CSTSR	214	DB6040C	228
CBTSS3	147	CHX8	145	CRATE124	44	CSUPR1826S6	223	DBC1826CW	228
CBU183672V4	226	CJ80CW-135	280	CRATE124BK	46	CSUPR6040S6	223	DBC1826P	228
CBU184272V4	226	CLRWSR36	328	CRATE126	44	CSWF	214, 225	DBRALG22R	243
CBU184872V4	226	CO-2098-CL	60	CRATE126K	46	CSWS1436SK	222	DC-101	78
CBU185472V4	226	CO-3065-CL	60	CRATE12BK	46	CSWS1436VK	222	DC-200	78
CBU186072V4	226	CO-3426-CL	60	CRATE12W	45	CSWS1448SK	222	DC10	28
CBU213672V4	226	CO2632	171	CRATE13	44	CSWS1448VK	222	DC1225	338
CBU214272V4	226	CO3200	171	CRATE134	44	CSWS1836SK	222	DC5	28
CBU214872V4	226	CO3253	171	CRATE134BK	46	CSWS1848SK	222	DC575	338
CBU215472V4	226	CO3343	171	CRATE136	44	CSWS36EK	222	DC700	338
CBU216072V4	226	CO3646	171	CRATE136BK	46	CSWS48EK	222	DC825	338
CBU243672V4	226	CO3753	171	CRATE13BK	46	CVC55	188	DCC10	28
CBU244272V4	226	CO3800	171	CRATE13W	45	CVC72	188	DCC5	28
CBU244872V4	226	CO4300	171	CRATE14	44	CVC724	188	DCH01	51
CBU245472V4	226	Contenido		CRATE14BK	46	CW2030BK CW2030R26		DCH27	51
CBU246072V4	226	CP-14820-2	342	CRATE14W	45	CW2032BK CW2032R26		DCH27BK	51
CBUPR1826S6	223	CP-17620-3	342	CRPHDG2878	343	CW30100	52	DCS1125	338
CBUPR6040S6	223	CP-19224-2	342	CS-10-	86, 88	CW30102	52	DCS950	338
CBV2552	144	CP-19224-3	342	CS-100-	83	CW30104	52	DG3CW	112
CBV6218	144	CP-22624-4	342	CS-1070-CN-W	85	CW30108	52	DISPSB-65	239
CC32	229	CP-28026-4	342	CS-1080-CN-W	85	CW30110	53	DIV12	186
CCP12	57	CP-28026-5	342	CS-1090-CN-W	85	CW30112	53	DIV20	186
CCP15	57	CP-28026-6	342	CS-1100-	84	CW30114	246	DP15	28
CCP27	57	CP-28031-3	342	CS-117-	86, 88	CW30116	246	DRC2020	342
CCPL12	57	CP-28031-4	342	CS-1180-CN-W	85	CW30118	246	DRLNK	228
CCPL27	57	CP-28031-5	342	CS-1198-CN-W	85	CW30122	52	DRS300	228
CD100	336	CP-31024-4	342	CS-1259-CN-W	85	CW30124	52	DRS30	228
CD100H	337	CP-31024-5	342	CS-1270-CN-W	85	CW30127	53	DRS360	228
CD100HB	337	CP-31024-6	342	CS-1280-	84	CW30130	247	DRS36	228
CD1313	335	CP-31054-3	342	CS-1450-CN-W	85	CW30132	247	DRS480	228
CD1327	335	CP-31054-4	342	CS-1811-CN-W	85	CW30134	247	DRS48	228
CD1420	335	CP-31054-5	342	CS-6100-W	15, 80	CW30140	52	DRS600	228
CD160	336	CP-31054-6	342	CS-6101-W	13, 81	CW30142	52	DRS60	228
CD1826H	335	CP-31334-3	342	CS-6102-W	15, 80	CW30146	53	DSPR6	144
CD1826HB	335	CP-31334-4	342	CS-6103-W	14, 81	CW30148	53	E3	346
CD1826MTC	336	CP-31334-5	342	CS-6104-W	81	CW30150	52	E5601	273

CODE	PAGE	CODE	PAGE	CODE	PAGE	CODE	PAGE	CODE	PAGE
E5602-JU	273	EPP4060FNR	298	FR-R107	242	GNP11020	290	GPP12100	291
E5602-SE	273	EPP4060FPR1	298	FR-RIDU2201	243	GNP11040	290	GPP12150	291
E5602	273	EPP4060T200	297	FR-RIDU2202	243	GNP11055	290	GPP21065	290
E5603	274	EPP4060T300	297	FR-RIDU2203	243	GNP11065	290	GPP21100	290
E5604	273	EPPBEVBKST	297	FR-RIDU2204	243	GNP11100	290	GPP21150	290
E5605	273	EPPBEVRDST	297	FR-RIDU2205	243	GNP11150	290	GPSS10	130
E5606	273	EPPCTL	299	FR-RIDU2206	243	GNP11200	290	GPSS120	130
E5607	273	EPPCTS	299	FR-RIDU2207	243	GNP12020	291	GPSS129	130
E5609	273	EPPEXT	300	FR-RUF2	243	GNP12040	291	GPSS8	130
E5614	274	EPPFLID	300	FR258	345	GNP12065	291	GPSS90	130
E5615	274	EPPIDS	299	FS-1001-YEL	365	GNP12100	291	GPSS96	130
E5616	274	EPPMBWSTSW	301	FSAGD2020	351	GNP12150	291	GPSSCADDY	130
E5617	274	EPPMD4835	180, 303	FSG480	184	GNP12200	291	GT33	129
E5618	274	EPPMDB4428	180, 303	FSG720	184	GNP13040	292	GT44	129
E5619	274	EPPZ35100	306	FSL1508	68	GNP13065	292	GT87	129
E5626	274	EPPZ35175	306	FSP1507	68	GNP13100	292	GTSS33	129, 130
E5627	274	EPPZ35175BST	306	FSR3	246	GNP13150	292	GTSS44	129, 130
E5629	274	EPPZ35175RST	306	FTR1711	93	GNP13200	292	GTSS87	129, 130
E5630	274	EPPZ35265	306	GB1200CW	112	GNP14065	292	GXL11000	290
E5632	274	EPPZ35265BST	306	GB850CW	112	GNP14100	292	H05021	368
E5698	273	EPPZ35265RST	306	GBCTUGNPR11-CLR	240	GNP14150	292	H06001	371
E6606	274	EPPZ35330	306	GBCTUGNPR21-CLR	241	GNP14200	292	H06002	371
E6607	274	EPPZ35330BST	306	GBD101011	307	GNP16065	292	H06014	371
EC-07-1-	309	EPPZ35330RST	306	GBD121515	307	GNP16100	292	H07001	368, 369
EC-08-1-	308	ES28	187	GBD13913	307	GNP16150	292	H110204	250
EC-09-1-	308	ES28RL	187	GBD151212	307	GNP16200	292	H1229	201
EC-10-1-	308	ESU183630V2	226	GBD211414	307	GNP19065	293	H158	280
EC-11-1-	308	ESU184830V2	226	GBD211417	307	GNP19100	293	H159	280
EC-12-1-	308	FB-PH116-1	256	GBP216	306	GNP21020	290	H15S&P	143
EC-13-1-	309	FB-PH124-1	256	GBP220	306	GNP21040	290	H19007	370
EC-15-2	308	FB-PP16-3KIT	256	GBP318	306	GNP21065	290	H2S&P	143
EC-16-	308	FB-PP16-BOTTLE-6	256	GBP518	306	GNP21100	290	H303	202
EC-17-JA	309	FB-PP1H-6	256	GET-22-	57	GNP21150	290	H4258	200
EC-18-JA	309	FB-PP24-3KIT	256	GET-25-	57	GNP21200	290	H475S&P	143
EC-19-	309	FB-PP24-BOTTLE-6	256	GHB10	201	GNP23020	291	H5001	275
EC-20-	309	FB-PP2H-6	256	GHB16	201	GNP23065	291	H503K	200
EC-21-	309	FB-PP3H-6	256	GHB24	201	GNP23100	291	H633	204
EC-23-	309	FB-PPAL-RINGS	256	GHC10	201	GNP23150	291	H6610	275
EC-24-	309	FC1649	68	GHC16	201	GNP23200	291	H6611	275
EC-25-1-	309	FCB1218A	277	GHC24	201	GNP24040	291	H6622	275
EMU142427V2	226	FFD8	262	GK2000	343	GNP24065	291	H714CH	201
EMU143627V2	226	FFR8	262	GL0540	154	GNP24100	291	H826	262
EMU144827V2	226	FI-18T0B-6	254	GL1070	154	GNP24150	291	H827	262
EPK1830	226	FI-18T3BX-6	254	GL1080	154	GOB-12-1-SAN-CL	113	H828	262
EPP140	300	FI-21T0B-6	254	GL3074	154	GOB-20-1-SAN-CL	113	H829	262
EPP160	297	FI-21T0C-6	254	GL3980	154	GP0540	155	HBR258	343, 346
EPP160CL	300	FI-21T3BX-6	254	GL4002	154	GP10	133	HBR414	343
EPP180	297	FI-24T0C-6	254	GL4060	154	GP1070	155	HBR578	343
EPP180CL	300	FI-FTDECO	255	GL4210	154	GP1080	155	HBR712	343
EPP180LH	297	FI-FTFRENCH	255	GL4701	154	GP12	133	HD12	206
EPP180S	297	FI-FTPLAIN	255	GND11000	290	GP129	133	HD8	206
EPP180X	301	FI-FTSTAR	255	GND12000	291	GP3074	155	HE3	346
EPP180XL	301	FLBEER4	42	GND13000	292	GP3980	155	HFLGLASS5	116
EPP180XLT	301	FLGLASS4	42	GND23000	291	GP4002	155	HFR258	345
EPP260	297	FLIGHT1	42	GNL11000	290	GP4004	155	HK39B	328
EPP280	297	FLIGHT2	42	GNL12000	291	GP4701	155	HP2632	299
EPP280BKST	297	FR-1002-BLA	357	GNL13000	292	GP4709	155	HP3253	299, 318
EPP280RDST	297	FR-1003-BLA	357	GNL14000	292	GP4856	155	HSMC3	258
EPP300	298	FR-DPIPUS23	243	GNL16000	292	GP8	133	HUR-1-CL	112
EPP3253DIV	299	FR-R100-KIT	243	GNL19000	293	GP96	133	HUR-20-PC-CL	113
EPP3253LID-110	297	FR-R101	242	GNL23000	291	GPP11020	290	HWAPR	312
EPP3253LID	300	FR-R102	242	GNLN11000	290	GPP11040	290	HWATD	312
EPP400	298	FR-R103	242	GNLN12000	291	GPP11065	290	IB27LIDCW	370
EPP4060F6R	298	FR-R104	242	GNLN13000	292	GPP11100	290	IB32	229
EPP4060F9R	298	FR-R105	242	GNLN16000	292	GPP11150	290	IB32LIDCW	370
EPP4060FADJR	298	FR-R106	242	GNLN19000	293	GPP12065	291	IB36	229

CODE	PAGE	CODE	PAGE	CODE	PAGE	CODE	PAGE	CODE	PAGE
IB36LIDCW	370	M-6030-BK	95	MG11100	30	ML-246-	12	MPA41318V4PKG	217
IB44	229	M-6030-RSP	95	MG1120	30	ML-247-	12, 21	MPA41418S4PKG	218
IB44LIDCW	370	M-6030-W	95	MG1165	30	ML-248-	12, 21	MPA41418V4PKG	217
IBS20	229	M-815-DW	77	MG12100	30	ML-249-	12, 21	MPA41518S4PKG	218
IBS27	229	M14	19	MG1265	30	ML-250-	12	MPA41518V4PKG	217
IBS37	229	M165	19	MG13100	30	ML-252-	14	MPA41618S4PKG	218
IBSF27	229	M18	19	MG1	33	ML-253-	14	MPA41618V4PKG	217
ICM-24-CL	113	M186	19	MG13	34	ML-254-	14	MPA41718S4PKG	218
ICM-25-CL	113	M2010	19	MG1365	30	ML-255-	14	MPA41718V4PKG	217
ICM-26-2-CL	113	M206	19	MG13DW	35	ML-256-	14	MPA4618S4PKG	218
ICM-27-CL	113	M2213	19	MG13WM	36	ML-257-	12	MPA4618V4PKG	217
ICS100L	191	M22	19	MG1465	30	ML-278-	12	MPA4718S4PKG	218
ICS100L4S	191	M2474	60	MG16	34	ML-279-	12	MPA4718V4PKG	217
ICS125L	191	M2475	60	MG1DW	35	ML-281-	12	MPA4818S4PKG	218
ICS125LB	191	M2485	60	MG1WM	36	ML-287-	14	MPA4818V4PKG	217
ICS125T	191	M2489	60	MG2	33	ML-294-W	18	MPA4918S4PKG	218
ICS175L	191	M2493	60	MG2420	30	ML-60-	11	MPA4918V4PKG	217
ICS175LB	191	M2511	19	MG2DW	35	ML-61-	11	MPA51018S4PKG	218
ICS175T	191	M2811	19	MG2WM	36	ML-62-	11	MPA51018V4PKG	217
ICS175TB	191	M4004	31	MG3	33	ML-63-	11	MPA51118S4PKG	218
ICS200TB	191	M4007	31	MG3DW	35	ML-63-RSP	11	MPA51118V4PKG	217
IT3753T	179	M4008	31	MG3WM	36	ML-64-	11	MPA51218S4PKG	218
ITENEPP	178	M4014	31	MGD1616	34	ML-65-	11	MPA51218V4PKG	217
ITENEPP21H	178	M4024	31	MGD16	34	ML-73-	10	MPA51318S4PKG	218
ITPD3253	179	M4026	31	MGD2112	34	ML-74-	10	MPA51318V4PKG	217
ITPD3753T	179	MA2028	172	MGL2	33	ML-75-	10	MPA51418S4PKG	218
JC1064A	193	MA2435	172	MGL2DW	35	ML-75-RSP	10	MPA51418V4PKG	217
JC1128A	193	MA3142H	172	MGL2WM	36	ML-77-	10	MPA51518S4PKG	218
JJ1202	193	MA3200	172	MJGLASS	65	ML-78-	10	MPA51518V4PKG	217
JJ1205	193	MA3343	172	MJRB3	65	ML-78-RSP	10	MPA51618S4PKG	218
JJ1206	193	MA3646	172	MJRM3	65	ML-79-	10	MPA51618V4PKG	217
KK1200	343	MA3652TR	172	MJS14	194	ML-79-RSP	10	MPA51718S4PKG	218
KK3	276	MA3753	172	MJS30	194	ML-80-	11	MPA51718V4PKG	217
KK3SRB2	276	MA3800	172	ML-102-	15	ML-81-	11	MPA5618S4PKG	218
KK3SRB	276	MA4300	172	ML-103-	15	ML-82-	11	MPA5618V4PKG	217
KSC402220	187	MA4361	172	ML-104-	15	ML-83-	11	MPA5718S4PKG	218
KVC854	187	MAS-3-CL	113	ML-109-	18	ML-83-RSP	11	MPA5718V4PKG	217
KVC854C	187	MB125ACA	25	ML-110-	18	ML-84-	11	MPA5818S4PKG	218
KVC856	187	MB166ACA	25	ML-111-	18	ML-87-	10	MPA5818V4PKG	217
KWS40	187	MB22	120	ML-112-	18	ML-87-RSP	10	MPA5918S4PKG	218
LCDCH10	312	MB32	120	ML-113-	18	ML-87	22	MPA5918V4PKG	217
LCDCH	312	MB63	120	ML-116-W	18	ML-88-	10	MPA61018S4PKG	218
LCDES	312	MB94ACA	25	ML-128-	18	ML-88	22	MPA61018V4PKG	217
LD105	55	MBT126	19	ML-129-W	18	ML-90-	15	MPA61118S4PKG	218
LD130	55	MCCH	287	ML-13-	10	ML-90	22	MPA61118V4PKG	217
LD85	55	MDC1411T60	327	ML-14-	11	ML-91-	15	MPA61218S4PKG	218
LDT10-	104	MDC1418S20	327	ML-15-	11	ML-91	22	MPA61218V4PKG	217
LDT12-	104	MDC1418T16	327	ML-154-	18	ML-92-	15	MPA61318S4PKG	218
LDT16-	104	MDC1418T30	327	ML-155-	18	ML-92	22	MPA61318V4PKG	217
LDT16-	104	MDC1520S20	327	ML-179-BK	18	ML-93-	13	MPA61418S4PKG	218
LDT22-	104	MDC1520T16	327	ML-210-W	17	ML-93	23	MPA61418V4PKG	217
LDT5-	104	MDC1520T30	327	ML-211-W	17	ML-94	23	MPA61518S4PKG	218
LDT6-	104	MDC24	326	ML-219-	16, 21	ML-95-	13	MPA61518V4PKG	217
LDT9-	104	MDC24F	326	ML-220-	16, 21	ML-95	23	MPA61618S4PKG	218
LL1R-2-12M	243	MDSB16	178, 328	ML-232-W	16	ML-99-	14	MPA61618V4PKG	217
LL7R-2	243	MDSB9	328	ML-233-W	16	MOJ-801-BK	93	MPA61718S4PKG	218
LT10	106	MDSB5	328	ML-234-W	16	MOJ-802-BK	93	MPA61718V4PKG	217
LT12-	106	MDSB9	328	ML-235-W	16	MOJ-803-BK	93	MPA6618S4PKG	218
LT14-	106	MDSL9	328	ML-238-	12	MOJ-804-BK	93	MPA6618V4PKG	217
LT16-	106	MDSL9	328	ML-239-	13	MPA41018S4PKG	218	MPA6718S4PKG	218
LT22-	106	MDSM8	328	ML-240-	14	MPA41018V4PKG	217	MPA6718V4PKG	217
LT6	106	MDSP9	328	ML-241	13	MPA41118S4PKG	218	MPA6818S4PKG	218
LT8	106	MDSPL	328	ML-242-	14	MPA41118V4PKG	217	MPA6818V4PKG	217
LUX-1816-M	163	MEDIUM	140	ML-243-	14	MPA41218S4PKG	218	MPA6918S4PKG	218
LUX-2121-M	163	MEDRARE	140	ML-244-	13	MPA41218V4PKG	217	MPA6918V4PKG	217
LUX-2518-M	163	MEDWELL	140	ML-245-	12	MPA41318S4PKG	218	MPD2415	19

CODE	PAGE	CODE	PAGE	CODE	PAGE	CODE	PAGE	CODE	PAGE
MPMPK40177	213	MPSK4080V1	213	MPU41718V4PKG	217	MSHD461117PK	222	OP-135-DW	76
MPMPK50177	213	MPSK4090S1	213	MPU461854PKG	218	MSHD461217PK	222	OP-145-DW	76
MPMPK60177	213	MPSK4090V1	213	MPU4618V4PKG	217	MSHD46917PK	222	OP-2280-	11
MPMU41017V4PKG	220	MPSK50100S1	213	MPU471854PKG	218	MSKLT65	100	OP-618-	11
MPMU41117V4PKG	220	MPSK50100V1	213	MPU4718V4PKG	217	MSKLT85	100	OP-618	22
MPMU41217V4PKG	220	MPSK50110S1	213	MPU481854PKG	218	MSSKLT5	100	OP-621-	11
MPMU41317V4PKG	220	MPSK50110V1	213	MPU4818V4PKG	217	MSSKLT65	100	OP-621	22
MPMU41417V4PKG	220	MPSK50120S1	213	MPU491854PKG	218	MSSKLT85	100	OP-630	22
MPMU41517V4PKG	220	MPSK50120V1	213	MPU4918V4PKG	217	MSV106	100	OP-950-DW	76
MPMU41617V4PKG	220	MPSK50130S1	213	MPU5101854PKG	218	MSV95	100	OP-960-	84
MPMU41717V4PKG	220	MPSK50130V1	213	MPU51018V4PKG	217	MTS-1122-BK	51	P-1000-BK	91
MPMU4617V4PKG	220	MPSK50140S1	213	MPU5111854PKG	218	MTS-1122-CH	51	P-1175-BK	91
MPMU4717V4PKG	220	MPSK50140V1	213	MPU51118V4PKG	217	MTS-1496-BK	51	P-12-1-CL	111
MPMU4817V4PKG	220	MPSK50150S1	213	MPU5121854PKG	218	MW2129	167	P-4050-PC-CL	115
MPMU4917V4PKG	220	MPSK50150V1	213	MPU51218V4PKG	217	MW3200	167	P-4072-PC-CL	115
MPMU51017V4PKG	220	MPSK50160S1	213	MPU5131854PKG	218	MW3245	167	P-4090-PC-	115
MPMU51117V4PKG	220	MPSK50160V1	213	MPU51318V4PKG	217	MW3600	167	P-4091-PC-	115
MPMU51217V4PKG	220	MPSK50170S1	213	MPU5141854PKG	218	MW3646	167	P-875-BK	91
MPMU51317V4PKG	220	MPSK50170V1	213	MPU51418V4PKG	217	MW3858	167	P135I-2	244
MPMU51417V4PKG	220	MPSK5060S1	213	MPU5151854PKG	218	MW40	266	P165I-2	244
MPMU51517V4PKG	220	MPSK5060V1	213	MPU51518V4PKG	217	MW4200	167	P18.5-SI-2	244
MPMU51617V4PKG	220	MPSK5070S1	213	MPU5161854PKG	218	MY2026	171	P265I-2	244
MPMU51717V4PKG	220	MPSK5070V1	213	MPU51618V4PKG	217	MY2129	171	P320CW	114
MPMU5617V4PKG	220	MPSK5080S1	213	MPU5171854PKG	218	MY2632	171	P34CW	114
MPMU5717V4PKG	220	MPSK5080V1	213	MPU51718V4PKG	217	MY2738	171	P34LCW	114
MPMU5817V4PKG	220	MPSK5090S1	213	MPU561854PKG	218	MY3200	171	P480CW	114
MPMU5917V4PKG	220	MPSK5090V1	213	MPU5618V4PKG	217	MY3244	171	P600CW	115
MPMU61017V4PKG	220	MPSK60100S1	213	MPU571854PKG	218	MY3253	171	P60CW	115
MPMU61117DRPKG	215	MPSK60100V1	213	MPU5718V4PKG	217	MY3343	171	P64CW	115
MPMU61117V4PKG	220	MPSK60110S1	213	MPU581854PKG	218	MY3446	171	PB-1002-BLA	364
MPMU61217PDPKG	215	MPSK60110V1	213	MPU5818V4PKG	217	MY3646	171	PB-1011-GRY	363
MPMU61217V4PKG	220	MPSK60120S1	213	MPU591854PKG	218	MY3753	171	PB-1012-BLU	363
MPMU61317DRPKG	215	MPSK60120V1	213	MPU5918V4PKG	217	MY3800	171	PB-1012-GRN	363
MPMU61317V4PKG	220	MPSK60130S1	213	MPU6101854PKG	218	MY3952	171	PB-1013-YEL	363
MPMU61417V4PKG	220	MPSK60130V1	213	MPU61018V4PKG	217, 222	MY4300	171	PB-1014-BLU	363
MPMU61517V4PKG	220	MPSK60140S1	213	MPU6111854PKG	218	MY4361	171	PB-1014-YEL	363
MPMU61617V4PKG	220	MPSK60140V1	213	MPU61118V4PKG	217, 222	N175	69	PB-1030	364
MPMU61717V4PKG	220	MPSK60150S1	213	MPU61118V4PKG	217, 222	N20C	251	PB-1031-GRY	364
MPMU6617V4PKG	220	MPSK60150V1	213	MPU6121854PKG	218	N20CBBQ	251	PB-1032-GRY	364
MPMU6717V4PKG	220	MPSK60160S1	213	MPU61218V4PKG	217, 222	N32A	192	PB-1033-GRY	364
MPMU6817V4PKG	220	MPSK60160V1	213	MPU6131854PKG	218	N32BR	192	PB-1034-GRY	364
MPMU6917V4PKG	220	MPSK60170S1	213	MPU61318V4PKG	217	N32GN	192	PB-1080-CLR	364
MPPK40180	213	MPSK60170V1	213	MPU6141854PKG	218	N32LPA	192	PB-1080	363
MPPK50180	213	MPSK6060S1	213	MPU61418V4PKG	217	N32R	192	PB-1081-GRY-LID	364
MPPK60180	213	MPSK6060V1	213	MPU6141854PKG	217	N32VA	192	PB-1082-GRY-LID	364
MPSK40100S1	213	MPSK6070S1	213	MPU61418V4PKG	217	N32W	192	PB-1083-GRY-LID	364
MPSK40100V1	213	MPSK6070V1	213	MPU6151854PKG	218	N32X	192	PB-1090-CLR	364
MPSK40110S1	213	MPSK6080S1	213	MPU61518V4PKG	217	N32Y	192	PB-1090	363
MPSK40110V1	213	MPSK6080V1	213	MPU6161854PKG	218	N63BBQ	251	PB-1142-GRY	357
MPSK40120S1	213	MPSK6090S1	213	MPU61618V4PKG	217	NT10-	105	PB-1142-WHT	357
MPSK40120V1	213	MPSK6090V1	213	MPU6171854PKG	218	NT12-	105	PB-3140-BLA	355
MPSK40130S1	213	MPU4101854PKG	218	MPU61718V4PKG	217	NT14-	105	PB-3140-MSSSTL	355
MPSK40130V1	213	MPU41018V4PKG	217	MPU661854PKG	218	NT16-	105	PB-3140-SIL	355
MPSK40140S1	213	MPU4111854PKG	218	MPU6618V4PKG	217	NT20-	105	PB-3140-SSSTL	355
MPSK40140V1	213	MPU41118V4PKG	217	MPU671854PKG	218	NT5-	105	PB-3142-BLA	356
MPSK40150S1	213	MPU4121854PKG	218	MPU6718V4PKG	217	NT8-	105	PB-3143-BLA	356
MPSK40150V1	213	MPU41218V4PKG	217	MPU681854PKG	218	NT9-	105	PC64CW	115
MPSK40160S1	213	MPU4131854PKG	218	MPU6818V4PKG	217	OD-3352-BLA	353	PCUCC4	323
MPSK40160V1	213	MPU41318V4PKG	217	MPU691854PKG	218	OD-6140-SBLU	353	PCUHC4	323
MPSK40170S1	213	MPU4141854PKG	218	MPU6918V4PKG	217, 222	OD-6140-SGRN	353	PCUHH4	323
MPSK40170V1	213	MPU41418V4PKG	217	MSSC	214	OD-6140-SRED	353	PCULC4	323
MPSK4060S1	213	MPU4151854PKG	218	MSDS40	214	OD-6140-SSSTL	353	PCULH4	323
MPSK4060V1	213	MPU41518V4PKG	217	MSDS50	214	OD-6140-SYEL	353	PCULP4	323
MPSK4070S1	213	MPU4161854PKG	218	MSDS60	214	OETR314	345	PCUPP4	323
MPSK4070V1	213	MPU41618V4PKG	217	MSHD461017PK	222	OP-120-DW	76	PD8	262
MPSK4080S1	213	MPU4171854PKG	218			OP-1291-	84	PE600CW	115

CODE	PAGE	CODE	PAGE	CODE	PAGE	CODE	PAGE	CODE	PAGE
PH35	129	RAM3	120	RFS2	230	RST-1814-	163	SFG1220	29
PH556010	166	RAM3F	120	RFS22PP	230	RST-1815-1-	163	SFG820	29
PH556016	167	RAM3R	119	RFS2PP	230	RST-2020-M	163	SFR1012	29
PH556020	166	RAM3RW	79	RFS2SCPP	230	RST-2516-	163	SFT1010	29
PH556026	167	RAM4BK	120	RFS4	230	RST-2517-1-	163	SFT1212	29
PH556030	166	RAM4BU	120	RFS4PP	230	RT3	9	SFT1515	29
PH556036	167	RAM4R	119	RFS6	230	RTT21BK	48	SFV1015	29
PH556040	166	RAM4RW	79	RFS6PP	230	RTT21MG	48	SG200	275
PH556046	167	RAM6	120	RFS6SCPP	230	RTT21N	48	SGN-01	146
PH556050	166	RAMS2	121	RFS8	230	RWS12	276	SGN-14	146
PH556056	167	RAMS3	121	RFS8PP	230	S-12-W	78	SGN-15	146
PH556510	166	RAMS4	121	RFSC12	144, 230	S209	204	SGN-24	146
PH556516	167	RARE	140	RFSC1	230	SB-1010-OW	37	SGN-25	145
PH556520	166	RB2	276	RFSC12PP	230	SB-1155-OW	37	SL362	205
PH556526	167	RB63	9	RFSC1PP	230	SB-1210-OW	37	SLL30	242
PH557010	166	RB9	9	RFSC2	230	SB-1375-COW	37	SO-1230-BASE	358, 359
PH557016	167	RBAM300	49	RFSC2PP	230	SB-1409-ACW	37	SO-1245-BASE	359
PH557020	166	RBK300	49	RFSC6	230	SB-1472-OW	37	SO-1245-BLA-BASE	358
PH557026	167	RC-2003-BLA	361	RFSC6PP	230	SB-2005-W	37	SO-1245-BLA-LID	358
PH557030	166	RC-2003-BLU	361	RFSCW12	230	SB-2010-OW	37	SO-1245-LID	359
PH557036	167	RC-2003-GRN	361	RFSCW1	230	SB-2011-W	37	SO-1270-BASE	358, 359
PH557040	166	RC-2003-GRY	361	RFSCW18	230	SB-775-OW	37		
PH557046	167	RC-2003-RED	361	RFSCW22	230	SB53A	250	SO-1290-BASE	359
PH558510	166	RC-2003-WHT	361	RFSCW2	230	SB53PR	250	SO-1290-BLA-BASE	358
PH558516	167	RC-2003-YEL	361	RFSCW4	230	SB55	29	SO-1290-BLA-LID	358
PH558520	166	RC-2003	229	RFSCW6	230	SB60	29	SO-1290-LID	359
PH558526	167	RC-2005-BLA	361	RFSCW8	230	SB63A	250	SO-6003-MBLA	354
PH558530	166	RC-2005-GRN	361	RFSCWC12	230	SB63PR	250	SO-6003-MSSTL	354
PH558536	167	RC-2005-GRY	361	RFSCWC1	230	SB6701	239	SO-6005-MBLA	354
PHB35	129	RC-2005-RED	361	RFSCWC2	230	SB6702	239	SO-6005-MSSTL	354
PL60CW	114	RC-2005-WHT	361	RFSCWC6	230	SB6703	239	SO-6012-MSSTL	354
PPB15	202	RC-2005-YEL	361	RG-161	276	SB6704	239	SO-6020-MSSTL	354
PPB18	202	RC-2005	229	RG-173	276	SB6705	239	SO-6030-MBLA	354
PPB23	202	RC-2013-BLA	362	RG-181	276	SB6706	239	SO-6030-MSSTL	354
PR314	345	RC-2013-GRN	362	RIB76	202	SB6707	239	SO-6205-SSSTL	355
PR500	345	RC-2013-GRY	362	RISER-3-W	50	SB80	29	SP10	266
PR59314	345	RC-2013-RED	362	RISER-6-W	50	SBH15	186	SP12	266
PR59500	345	RC-2013-WHT	362	RISER-9-W	50	SBH18	186	SP14	266
PR8	262	RC-2013-YEL	362	RMG1ACA	50	SC-66	148	SP16	266
PS1014	176	RC-2013	229	RMG1BK	50	SC337	331	SPA14	57
PS13	263	RC-2015-BLA	362	RMG2ACA	50	SC337S	331	SPASL14	57
PT-10-MN-W	90	RC-2015-GRN	362	RMG2BK	50	SCH400SL	208	SPO13	57
PT-129-MN-W	90	RC-2015-GRY	362	RO-1100-B-LID	360	SCP12CW	199, 258	SPOP13	57
PT-6-MN-W	90	RC-2015-RED	362	RO-1100-G-LID	360	SCP24CW	199, 258	SRB13	144
PT-7-MN-W	90	RC-2015-WHT	362	RO-1100-GBLU	360	SCP64CW	199, 258	SRB13CW	144
PT1014	164	RC-2015-YEL	362	RO-1100-GGRN	360	SCP6CW	199, 258	SRB5	144
PT1100	164	RC-2015	229	RO-1100-GGRY		SD-3828-BK	92	SRB5CW	144
PT1216	164	RC-2092-BLA	362	et RO-1100-GLGR	360	SD-5525-BK	92	SSR1	323
PT1400	164	RC-2092	229	RO-1100-GRED	360	SF10	266	SSR8	323
PT1418	164	RCBCRATE1	47	RO-1100-GRY-LID	360	SF12	266	SSTB-11	147
PT1600	164	RCBCRATE2	47	RO-1100-GRY	360	SF14	266	SSTB-6	147
PWB22	144	RCBR555	48	RO-1100-GYEL	360	SF16	266	ST-0010-GRY	357
QCSB	331	RCBR668	48	RO-1100-LGR-LID	360	SF18	266	ST-0010-WHT	357
QCTB	331	RCBR9910	48	RO-1100-R-LID	360	SF20	266	ST-0015-GRY	357
R1000LCD	312	RCBS1387	48	RO-1100-Y-LID	360	SF24	266	ST-0025-GRY	357
R247	9	RCBS445	48	RP-1145-BK	92	SFC12	231	ST-0025-WHT	357
R500LCD	312	RCH21	145	RP-1253-BK	92	SFC12SCPP	231	ST-0050-GRY	357
RACA300	49	RFS12	230	RP-1490-BK	92	SFC12SCPP 441	232	ST-0050-WHT	357
RAM15	119	RFS1	230	RP68	9, 118	SFC2	231	ST-1511-BK	59
RAM15F	119	RFS12PP	230	RPD2415	9	SFC2SCPP	231	ST363B-1	350
RAM1F	119	RFS12SCPP	230	RR3	43	SFC2SCPP 441	232	ST365R-1	350
RAM2	119	RFS18	230	RS1432	204	SFC6	231	STM-85-BK	95
RAM2BU	120	RFS18PP	230	RS2132	204	SFC6SCPP	231	SU-2-DW	78
RAM2F	120	RFS1PP	230	RS3	43	SFC6SCPP 441	232	SU-3-DW	78
RAM2R	119	RFS1SCPP	230	RST-1522-	163	SFG1012	29	SU-4-DW	78
RAM2RW	79	RFS22	230	RST-1523-	163	SFG1015	29	SW-1401-1-SAN-CL	110

CODE	PAGE	CODE	PAGE	CODE	PAGE	CODE	PAGE	CODE	PAGE
SW-1402-1-SAN-CL	110	TDC30	339	UPC180	314	VL3253	154	WB-1508-	58
SW-1403-1-SAN-CL	110	TDCR12	334	UPC300	316	VL3343	154	WB-1509-	58
SW-1404-1-SAN-CL	110	THAGD2020	351	UPC400	315	VL3343C	154	WB-1510-	59
SW-1405-1-SAN-CL	110	TK05150	289	UPC600	319	VL3646C	154	WB-1513-TT	58
SW-1406-1-SAN-CL	110	TK05151	289	UPC800	319	VL3753	154	WB-1514-TT	59
SW-1407-1-SAN-CL	110	TK05180	289	UPCH16002	321	VT1216	155	WB-1515-TT	59
SW-1408-1-CL	107	TK05181	289	UPCH4002	320	VT1418	155	WB-1516-TT	59
SW-1409-1-CL	107	TK06150	288	UPCH8002	321	VT2632	155	WB-1517-TT	59
SW-1413-1-CL	113	TK06180	288	UPCHBD16002	321	VT3253	155	WB-1518-TT	58
SW-1414-1-CL	113	TK50362	289	UPCHBD8002	321	VT3343	155	WB-1519-TT	58
SW-1415-1-SAN-CL	110	TK50422	289	UPCHD4002	320	VT3343C	155	WB-1520-TT	58
SW-1416-1-CL	107	TK55152	289	UPCHT16002	321	VT3646C	155	WB-1521-TT	59
SW-1417-1-SAN-CL	111	TK55182	289	UPCHT8002	321	VT3753	155	WB-1522-TT	59
SW-1419-1-SAN-CL	110	TK56152	288	UPCHTD16002	321	VT3853	155	WB-1523-TT	59
SW-1420-1-SAN-CL	110	TK56182	288	UPCHTD8002	321	VTC3253T	168	WB-1524-	58
SW-1423-1-SAN-CL	103	TK57782	288	UPCHW4002	320	VTC3253TNS	169	WB-1551-	60
SW-1424-1-SAN-CL	103	TK88000	289	UPCS140	313	VTC3343T	168	WB-1552-	60
SW-1425-1-CL	106	TK88500	289	UPCS160	313	VTC3343TNS	169	WB-1553-	60
SW-1426-1-SAN-CL	103	TK92203	288	UPCS180	313	VTC3646T	168	WB-1616-RWD	47
SW-1427-1-CL	106	TK92204	288	VBR5	182	VTC3646TNS	169	WB13	19
SW-1428-1-SAN-CL	113	TK94433	279	VBR6	182	VTC3753T	168	WB16	19
SW-1429-1-SAN-CL	103	TK94443	279	VBRC	183	VTC3753TNS	169	WB7	19
SW-1430-1-CL	110	TK94453	279	VBRC90	183	VTCT3253T	169	WB9	19
SW-1431-1-CL	107	TM-1208-W	78	VBRCVR5	184	VTCT3343T	169	WC100CW	202
SW-1432-1-CL	110	TM-1308-W	78	VBRCVR6	184	VTCT3646T	169	WC100CWNH	202
SW-1433-1-CL	106	TRS12	126	VBRR5	184	VTCT3753T	169	WCR1220	187
SW-1434-CL	112	TRS23	126	VBRR6	184	W12	265	WCR1220	188
SW-1435-CL	112	TRS34	126	VBRSHTS	186	W14	265	WELLDONE	140
SW-1439-1-CL	102	TRSP12	126	VBRT5	182	W16	265	WF200BK	116
SW-1440-1-CL	102	TRSP23	126	VBRT6	182	W18	265	WM1	147
SW-1441-1-CL	102	TRSP34	126	VBRTBL	184	WB-1-SET-RWD	47	WP-10-DW	76
SW-1442-1-CL	102	TRW12	126	VBRTCVR5	184	WB-1011-MSSTL	355	WP-12-DW	76
SW-1443-1-CL	103	TRW23	126	VBRTCVR6	184	WB-1042-BLA	355	WP-5-DW	76
SW-1444-1-CL	103	TRW34	126	VBRU5	182	WB-1042-BRN	355	WP-6-DW	76
SW-1448-1-CL	102	TS-800-	93	VBRU6	182	WB-1051-BEI	355	WP-7-DW	76
SW-1449-CL	113	UC1000	312	VBRWC	186	WB-1051-BLA	355	WP-9-DW	76
SW-1460-CL	102	UC250	312	VCS	182	WB-1051-SSSTL	355	WPA5B	350
SW-1461-CL	102	UC500	312	VCS32CNT	183	WB-1251-BLA	355	WPA5BK	350
SW-1467-CL	113	UCW01	53	VCS32KEYT	186	WB-1251-SSSTL	355	WPA5SS	350
SW-1612-CPR	116	UCW10	53	VCS32R	184	WB-1252-BLA	355	WR60406	326
SW-1612-SS	116	UGNPR11F18	240	VCSCNL	183	WB-1252-SSSTL	355	WR60407	326
T3456	252	UGNPR11H9	240	VCSCVR	186	WB-1253-BLA	356	WSC12	279
T4	252	UGNPR21F36	241	VCSHD	182	WB-1253-SSSTL	356	WW1000	117
T6	252	UGNPR21H18	241	VCSWR	182	WB-1261-BLA	356	WW1000L	118
T8	252	UPC100	314	VCSWRHD	182	WB-1261-SSSTL	356	WW1000LS	118
TB1164	272	UPC1200	319	VL1014	154	WB-1271-BLA	356	WW1500	117
TB60	272	UPC140	314	VL1216	154	WB-1271-SSSTL	356	WW250	117
TC1418	334	UPC1600	319	VL1418	154	WB-1506-	58	WW250L	118
TDC2029	334	UPC160	314	VL2632	154	WB-1507-	58	WW500	117

GUIDE DE PERSONNALISATION



	QUANTITÉ MINIMUM	COÛT FIXE INITIAL DE LA COMMANDE	COÛT NET PAR UNITÉ
Verres, verres à pied et carafes G.E.T. à 1 couleur	144	95,00	0,55
Verres, verres à pied et carafes G.E.T. à plusieurs couleurs	4.800	175,00	0,65
Vaisselle en mélamine G.E.T.	1.200	Nous consulter	Nous consulter
Plateau CAMBRO Camtray	144	-	0,75
Plateau CAMBRO SMC	144	-	1,75
Plateau CAMBRO stratifié	144	-	1,00
Autres produits CAMBRO personnalisables	6 boîtes	125,00	0,30
Poêles Al Black	72	-	-

La surface d'impression est de 6 mm à 10 cm en fonction de la surface imprimable de chaque produit, sauf pour les plateaux.

1. Vous devez fournir design final au format numérique à 100% de sa taille et une résolution de 300 ppp. Le format du fichier doit être .jpeg, .tiff ou .eps. À envoyer à info@dbmark.com.
2. Tous les frais de personnalisation sont nets. Aucun rabais n'est admis.



INFORMATION SUR MATERIAUX PLASTIQUES

		Niveau de températures	Couleur	Résistance à la casse
POLYCARBONATE		-40 à 99 °C	Transparent	Excellente
HIGH HEAT		-40 à 190 °C	Translucide	Excellente
POLYETHYLÈNE		-40 à 70 °C	Opaque	Bonne
POLYPROPYLÈNE		-40 à 70 °C	Translucide	Normale
SAN		-20 à 80 °C	Transparent	Bonne
MÉLAMINE		-20 à 95 °C	Opaque	Bonne

GUIDE DE REFERENCE DE CASIERS POUR TASSES



A large square diagram representing a 16-compartment tray. In the top-left corner, there is a red arrow pointing towards the center. In the center, the number '16' is written in a large, light red font. Below the number, the text 'CASIERS DE TAILLE STANDARD' is written in a smaller, black font. Further down, the text 'COMPARTIMENTS' is written, followed by the dimensions '11,1 x 11,1 cm'.

Pour déterminer la taille du compartiment de la tasse :

Retournez la tasse et placez-la en diagonale dans le carré. Alignez la flèche du carré avec l'anse de la tasse. La tasse et l'anse doivent rester complètement dans les marges de l'un des carrés pour être sûr qu'il s'agit du bon casier.

Pour déterminer la hauteur du compartiment de la tasse :

Placez la base de la tasse sur une surface plane et tenez le guide de mesures (joint page suivante) verticalement à côté de la tasse afin de mesurer sa hauteur. Si elle mesure plus de 10,8 cm, vous pouvez ajouter des extensions E2 et HE2.

Guide rapide : Casiers de taille standard pour tasses

Largeur maximale de la tasse	Nb de compartiments	Hauteur maximale de la tasse		
		6,6 cm	10,7 cm	14,9 cm
11,1 cm	16	16C58	16C414	16C578
8,8 cm	20	20C58	20C414	NA

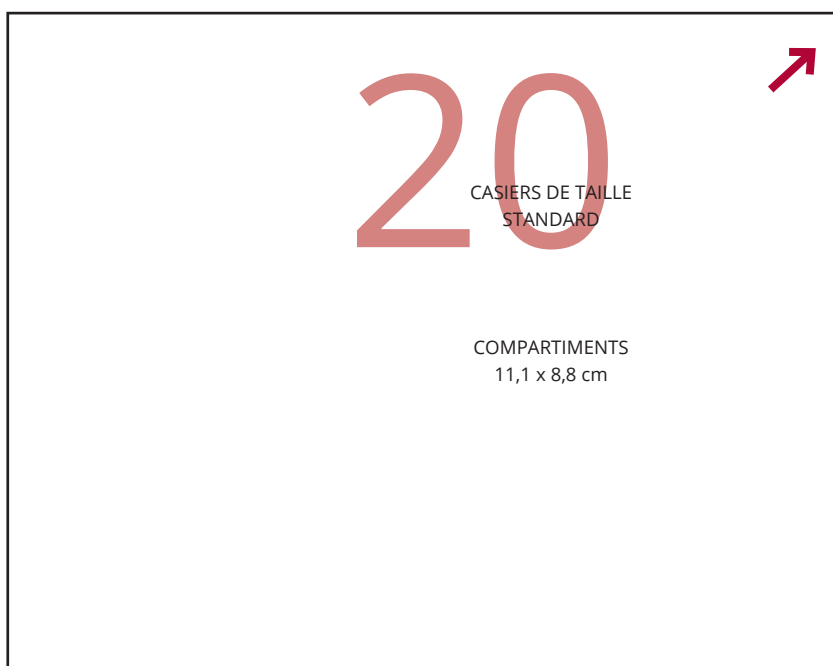

A large square diagram representing a 20-compartment tray. In the top-right corner, there is a red arrow pointing towards the center. In the center, the number '20' is written in a large, light red font. Below the number, the text 'CASIERS DE TAILLE STANDARD' is written in a smaller, black font. Further down, the text 'COMPARTIMENTS' is written, followed by the dimensions '11,1 x 8,8 cm'.

GUIDE DE RÉFÉRENCE DE CASIERS POUR VERRES À PIEDS ET AUTRES VERRES

Pour déterminer la hauteur du verre ou du verre à pied :

Utilisez les graduations pour déterminer la hauteur de l'article et le nombre approprié du casier.

Guide des diamètres et compartiments :

Placez le verre ou le verre à pied renversé sur le diagramme de carrés et hexagones. La figure sur laquelle tient le plus grand diamètre du verre déterminera le nombre de compartiments nécessaires.

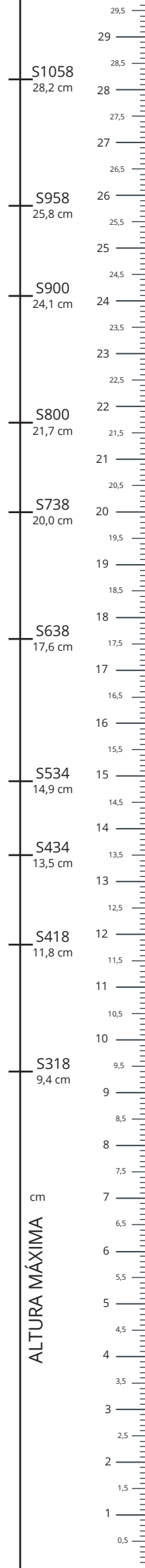
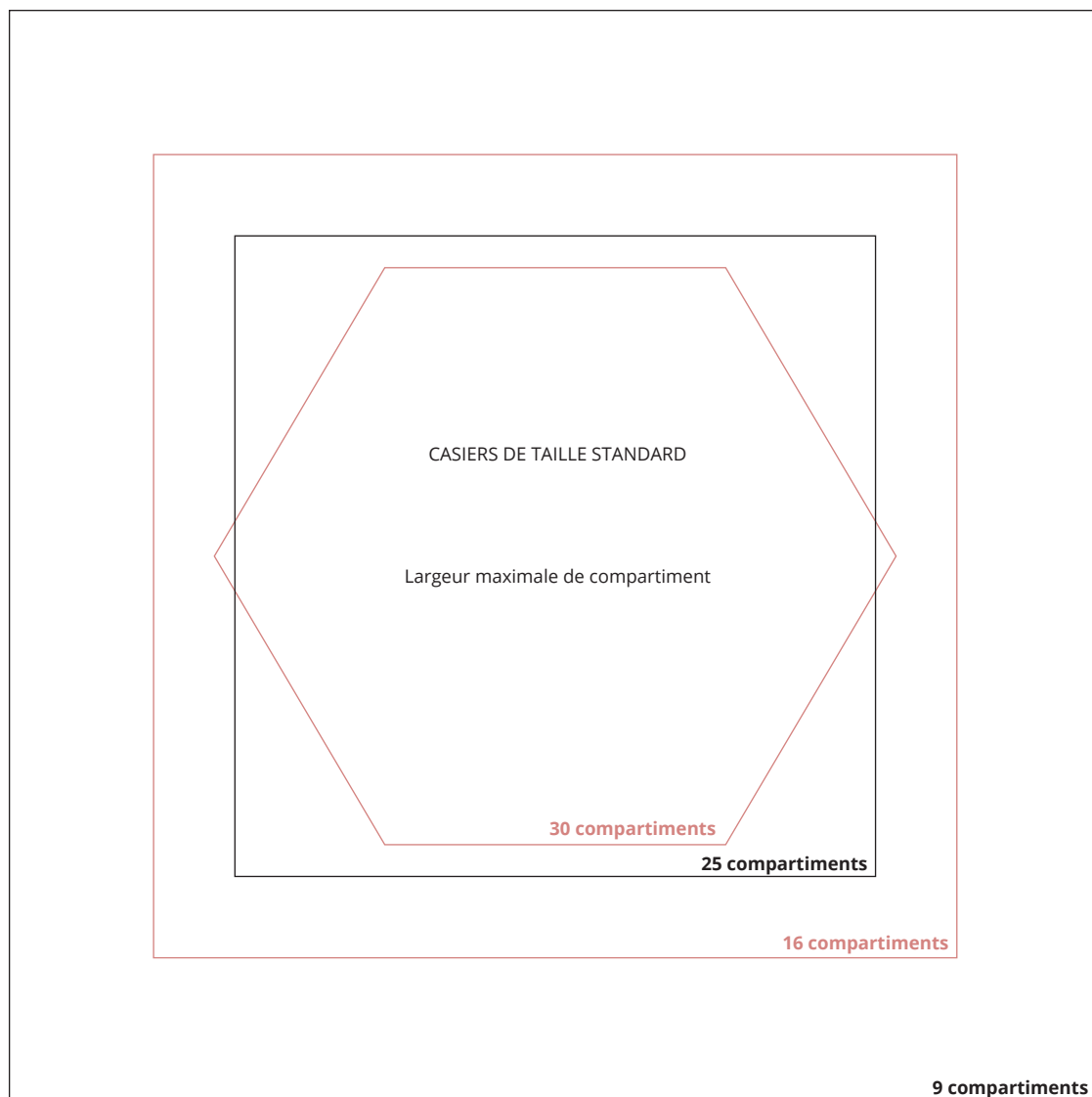
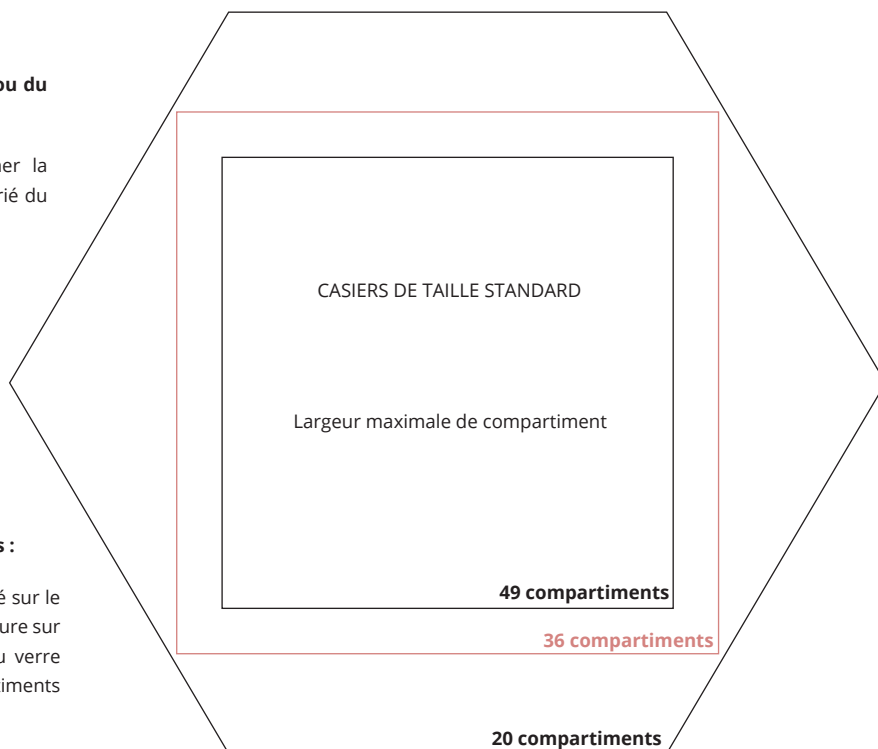

S1058
28,2 cm

S958
25,8 cm

S900
24,1 cm

S800
21,7 cm

S738
20,0 cm

S638
17,6 cm

S534
14,9 cm

S434
13,5 cm

S418
11,8 cm

S318
9,4 cm

ALTURA MÁXIMA

cm

CHERCHEZ VOS PIÈCES DE RECHANGES

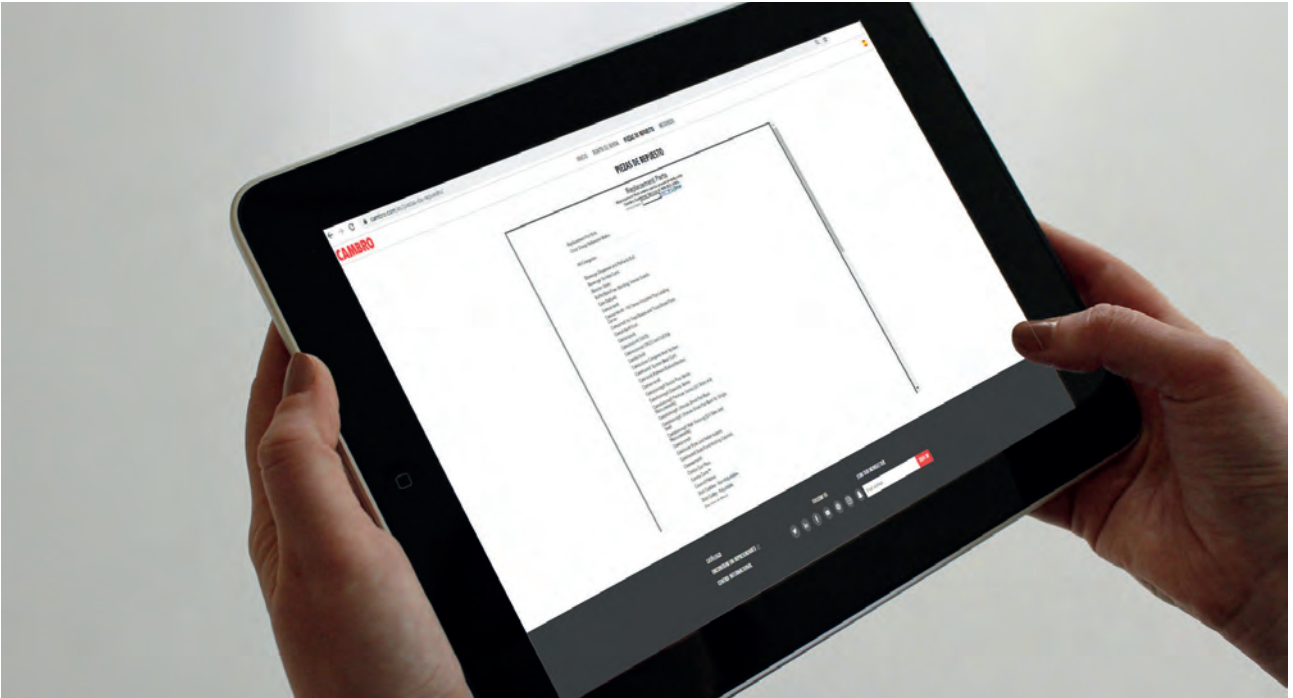

Sur le site internet de CAMBRO vous pourrez trouver un guide complet de pièces de rechange.

<https://www.cambro.com/fr/pièces-de-rechange/>

CAMBRO

[PIÈCES DE RECHANGE](#)
[OÙ ACHETER](#)
[RESSOURCES](#)
[CARRIÈRES](#)

PIÈCES DE RECHANGE

Beverage Dispenser and Pail with Bail



CODE	C.G.	PART FITS THIS PRODUCT	DESCRIPTION	USD LIST PRICE
46017		DSPR6	1-White Faucet	10.80
13219		DSPR6	6-Imprinted Beverage Label Set	4.05
60022		DSPR6, PWB22 (Units Before 12/03)	1-Bail	6.05
46044		DSPR6, PWB22 (Units After 12/03)	1-Bail	4.00
RF5C12		DSPR6, PWB22	1-White Lid	5.70

Beverage Service Carts



CODE	C.G.	PART FITS THIS PRODUCT	DESCRIPTION	USD LIST PRICE
60032		All Beverage Service Carts	1-6\" Fixed Caster w/Fasteners (60300)	39.45
60033		All Beverage Service Carts	1-6\" Swivel Caster w/Brake, and fasteners (60300)	47.90
60034		All Beverage Service Carts	1-6\" Swivel Caster w/fasteners (60300)	41.55

dbmark





Housse en silicone

Page 45



Collection Lattice

Page 131



Camtray Décor

Page 159



Boîte à repas

Page 180



Échelles Gastronomes

Page 240



Planches à découper

Page 278



Eco-Takeouts

Page 308



Distributeurs de gel

Page 351



Collecteurs antimicrobiens

Page 358



Avda. Sierra de Grazalema, 25 · 28691 Villanueva de la Cañada - Madrid - ESPAGNE

· E 918 125 580 · F 918 125 582 · info@dbmark.com

Service client 01 86 26 67 28

www.dbmark.com

Retrouvez-nous sur :

